

TECHNICAL MANUAL

UNIT AND DIRECT SUPPORT (DS) MAINTENANCE MANUAL (INCLUDING REPAIR PARTS AND SPECIAL TOOLS LIST) FOR

PARACHUTES, PERSONNEL TYPE:

**35-FOOT DIAMETER, MC1-1C
TROOP BACK PARACHUTE ASSEMBLY
NSN 1670-01-262-2359**

**35-FOOT DIAMETER, MC1-1D
TROOP BACK PARACHUTE ASSEMBLY
NSN 1670-01-487-0777**

DISTRIBUTION STATEMENT A: Approved for public release; distribution is unlimited.

* This manual supercedes TM 10-1670-292-23&P, dated 16 September 1988

HEADQUARTERS, DEPARTMENT OF THE ARMY

Change 1 30 NOVEMBER 2003

**1 FEBRUARY 2002
PCN 1840475400**

TM 10-1670-292-23&P

CHANGE
NO. 1

HEADQUARTERS, DEPARTMENT OF THE ARMY
WASHINGTON, DC, 30 November 2003

TECHNICAL MANUAL

UNIT AND DIRECT SUPPORT (DS)
MAINTENANCE MANUAL,
INCLUDING REPAIR PARTS AND SPECIAL TOOLS LIST
FOR

PARACHUTES, PERSONNEL TYPE:

35-FOOT DIAMETER, MC1-1C
NSN: 1670-01-262-2359

35-FOOT DIAMETER, MC1-1D
NSN: 1670-01-487-0777

DISTRIBUTION STATEMENT A: - Approved for public release; distribution is unlimited.

TM 10-1670-292-23&P, 1 February 2002, is updated as follows:

1. File this sheet in front of the manual for reference.
2. This change is a result of corrected content pertaining to the Universal Static Line.
3. New or updated text is indicated by a vertical bar in the outer margin of the page.
4. Remove old pages and insert new pages as indicated below:

Remove Pages

Front Cover
A/B
i/ii
Electronic 2028 Ins
Sample DA 2028
DA 2028s

Insert Pages

Front Cover
A/B
i/ii
Electronic 2028 Ins
Sample DA 2028
DA 2028s

5. Replace the following work packages with their revised version:

Work Package Number

WP 0002 00
WP 0008 00
WP 0009 00
WP 0010 00
WP 0011 00
WP 0030 00
WP 0031 00
WP 0044 00
WP 0047 00
WP 0048 00

TM 10-1670-292-23&P
C1

By Order of the Secretaries of the Army, Air Force, and Navy (Including the Marine Corps):

Official:

JOEL B. HUDSON
*Administrative Assistant to the
Secretary of the Army*
0329302

PETER J. SCHOOMAKER
General, United States Army
Chief of Staff

Official:

GEORGE T. BABBETT
General, USAF
Commander, Air Force Materiel Command

MICHAEL E. RYAN
GENERAL, USAF
Chief of Staff

R.P. SHOCKEY
Director, Program Support
Marine Corps Systems Command

D.G. MORRAL
Rear Admiral, USN
Program Executive Officer
For Expeditionary Warfare
Naval Sea Systems Command

DISTRIBUTION:

To be distributed in accordance with initial distribution IDN 253647, requirements for
TM 10-1670-292-23&P.

WARNING SUMMARY

This warning summary contains general safety warnings and hazardous material warnings that must be understood and applied during operation and maintenance of this equipment. Failure to observe these precautions could result in serious injury or death to personnel.

WARNING

DEATH could result if inspections are not performed as specified in this manual. Perform all inspections as specified.

WARNING

For First Aid treatment, refer to FM 4-25.11.

WARNING

Exercise extreme care when using petroleum products to destroy equipment by fire, as these materials are highly flammable. Improper handling may cause injury to personnel.

WARNING

Failure to detect areas of damage may result in malfunction of the parachute and injury or loss of life to personnel.

WARNING

Inspect the deployment bag and the entire static line, including that portion under sleeve. Failure to do so may cause serious injury or death to personnel.

WARNING

The limitations prescribed for parachute canopy patching will be stringently adhered to under all circumstances and without any deviations. Failure to do so may result in death or serious injury to personnel.

WARNING

Deployment bag will be given a complete inspection, including static line and that portion of the static line that is covered by the static line sleeve. Failure to do so could result in serious injury or death to the parachutist.

WARNING

Dress each gore section and the anti-inversion net to insure no foreign material is present. If foreign material is present, repeat fine dress procedures. Failure to do so could cause serious injury or death to the parachutist.

INSERT LATEST UPDATED PAGES/WORK PACKAGES, DESTROY SUPERSEDED DATA

LIST OF EFFECTIVE PAGES/WORK PACKAGES

NOTE: The portion of text affected by the update is indicated by a vertical line in the outer margins of the page. Updates to illustrations are indicated by miniature pointing hands.

Dates of issue for original and changed pages / work packages are:

Original .. 0 .. 1 Feb 02

Change .. 0 .. 30 Nov 03

Total number of pages for front and rear matter is 20. The total number of work packages is 56 consisting of the following:

| Page/ Work Package No. | *Change No. | Page/ Work Package No. | *Change No. |
|-------------------------------|--------------------|-------------------------------|--------------------|
| Front Cover | 1 | Index | 0 |
| a - b | 0 | Electronic 2028 Instructions | 1 |
| A – B | 1 | Sample 2028 | 1 |
| i-ii | 1 | Blank Form 2028 | 1 |
| iii-iv | 0 | | |
| WP 0001 00 | 0 | | |
| WP 0002 00 | 1 | | |
| WP 0003 00 - 0007 00 | 0 | | |
| WP 0008 00 - 0011 00 | 1 | | |
| WP 0012 00 - 0029 00 | 0 | | |
| WP 0030 00 - 0031 00 | 1 | | |
| WP 0032 00 - 0043 00 | 0 | | |
| WP 0044 00 | 1 | | |
| WP 0045 00 - 0046 00 | 0 | | |
| WP 0047 00 - 0048 00 | 1 | | |
| WP 0049 00 – 0056 00 | 0 | | |

***Zero in this column indicates an original page or work package**

THIS PAGE INTENTIONALLY LEFT BLANK

TECHNICAL MANUAL

UNIT AND DIRECT SUPPORT (DS) MAINTENANCE MANUAL (INCLUDING REPAIR PARTS AND SPECIAL TOOLS LIST) FOR PARACHUTE, PERSONNEL TYPE:

35-FOOT DIAMETER, MC1-1C
TROOP BACK PARACHUTE ASSEMBLY
NSN 1670-01-262-2359

35-FOOT DIAMETER, MC1-1D
TROOP BACK PARACHUTE ASSEMBLY
NSN 1670-01-487-0777

REPORTING ERRORS AND RECOMMENDING IMPROVEMENTS

ARMY

You can help improve this manual. If you find any mistakes or if you know of a way to improve the procedures, please let us know. Mail your letter, DA Form 2028 (Recommended Changes to Publications and Blank Forms), or DA Form 2028-2, located in the back of this manual directly to: Commander, US Army Tank-automotive & Armament Command, ATTN: AMSTA-LC-CECT, Kansas St., Natick, MA 01760. You may also submit your recommended changes by E-mail directly to: amssbriml@natick.army.mil. A reply will be furnished directly to you. Instructions for sending electronic 2028 may be found at the back of this manual immediately preceding the hard copy 2028.

AIR FORCE

Reports by U.S. Air Force units should be submitted on AFTO Form 22 (Technical Order Publication Improvement Report and Reply) and forwarded to the address prescribed above for the Army. An information copy of the prepared AFTO Form 22 shall be furnished to WP-ALC/TILTA, 420 2nd Street, Suite 100, Robins AFB, GA 31098-1640.

MARINE CORPS

Marine Corps personnel submit NAVMC 10772 for to commander, ATTN: (Code 850), Marine Corps Logistics Bases, 814 Radford Blvd., Albany, GA 31704-1128.

NAVY

Submit NAVSEA Form 4160/1 (REV 2-99) to Commander, NSDSA Code 5E30, NAVSURFCENDIV, 4363 Missile Way, Port Hueneme, CA 93043-4307. A Reply will be sent to you.

DISTRIBUTION STATEMENT A: Approved for public release; distribution is unlimited.

*This manual supercedes TM 10-1670-292-23&P, dated 16 September 1988

TABLE OF CONTENTS

WP Sequence No.

WARNING SUMMARY

HOW TO USE THIS MANUAL

CHAPTER 1 – INTRODUCTORY INFORMATION

| | |
|-------------------------------------|---------|
| General Information..... | 0001 00 |
| Equipment Description and Data..... | 0002 00 |

CHAPTER 2 - OPERATOR MAINTENANCE INSTRUCTIONS

| | |
|---|---------|
| Service Upon Receipt | 0003 00 |
| Assembling the MC1-1C/MC1-1D Troop Back Parachute | 0004 00 |
| Preventive Maintenance Checks and Services (PMCS), Introduction | 0005 00 |
| Preventive Maintenance Checks and Services (PMCS) | 0006 00 |

CHAPTER 3 – UNIT MAINTENANCE INSTRUCTIONS

| | |
|---|---------|
| Shakeout and Airing | 0007 00 |
| Cleaning and Drying | 0008 00 |
| Inspection | 0009 00 |
| Salt-/Fresh-Water Contamination Test..... | 0010 00 |
| Packing Procedures | 0011 00 |
| Sewing Procedures | 0012 00 |
| Searing and Waxing | 0013 00 |
| Marking and Restencilling | 0014 00 |
| Bridle Loop | 0015 00 |
| Orifice Edge Reinforcement | 0016 00 |
| Upper Lateral Band | 0017 00 |
| Gore Sections | 0018 00 |
| Radial Seam | 0019 00 |
| Lower Lateral Band | 0020 00 |
| Pocket Band | 0021 00 |
| V-Tabs | 0022 00 |
| Anti-Inversion Net | 0023 00 |
| Suspension Line | 0024 00 |
| Control Line Bridle..... | 0025 00 |
| Control Line | 0026 00 |
| Connector Link Assembly | 0027 00 |
| Risers | 0028 00 |
| Deployment Bag | 0029 00 |
| Harness Assembly | 0030 00 |
| Pack Tray | 0031 00 |

TABLE OF CONTENTS - Continued

WP Sequence No.

CHAPTER 4 – DIRECT SUPPORT MAINTENANCE INSTRUCTIONS

| | |
|---------------------------------|---------|
| Sewing Procedures | 0032 00 |
| Searing and Waxing | 0033 00 |
| Marking and Restencilling | 0034 00 |
| Vent Lines | 0035 00 |
| Gore Sections | 0036 00 |
| Radial Tape | 0037 00 |
| Suspension Line | 0038 00 |
| Preparation for Storage | 0039 00 |
| Preparation for Shipment..... | 0040 00 |

CHAPTER 5 – SUPPORTING INFORMATION

| | |
|--|---------|
| References | 0041 00 |
| Maintenance Allocation Chart (MAC) | 0042 00 |
| Repair Parts and Special Tools List (RPSTL), Introduction..... | 0043 00 |
| RPSTL – Group 00, MC1-1C/MC1-1D Troop Back Personnel Parachute | 0044 00 |
| RPSTL – Group 01, Personnel Canopy With Net and Orifice | 0045 00 |
| RPSTL – Group 02, Riser Extension | 0046 00 |
| RPSTL – Group 03, Standard Deployment Bag | 0047 00 |
| RPSTL – Group 04, Universal Static Line | 0048 00 |
| RPSTL – Group 05, Personnel Parachute Harness | 0049 00 |
| RPSTL – Group 06, Personnel Parachute Pack Tray | 0050 00 |
| RPSTL – Group 99, Bulk Materials | 0051 00 |
| Special Tools List | 0052 00 |
| National Stock Number Index..... | 0053 00 |
| Part Number Index | 0054 00 |
| Expendable/Durable Supplies and Materials List | 0055 00 |
| Illustrated List of Manufactured Items | 0056 00 |

| | |
|--------------------------------|----------------|
| ALPHABETICAL INDEX..... | INDEX 1 |
|--------------------------------|----------------|

THIS PAGE INTENTIONALLY LEFT BLANK

HOW TO USE THIS MANUAL

In this manual, primary chapters appear in upper case/capital letters; work packages are presented in numeric sequence, e.g., 0001 00; paragraphs within a work package are not numbered and are presented in a titles format. For a first level paragraph, title all upper case/capital letters, e.g., FRONT MATTER subordinate paragraph title will have the first letter of the first word of each principle word all upper case/capital letters, e.g., Manual Organization and Page Numbering System. The location of additional material that must be referenced is clearly marked. Illustrations supporting maintenance procedures/text are located underneath, or as close as possible to, their referenced paragraph.

FRONT MATTER. Front matter consists of front cover, warning summary, title block, table of contents, and how to use this manual page.

CHAPTER 1 - INTRODUCTION. Chapter 1 contains general information and equipment.

CHAPTER 2 - OPERATOR INSTRUCTIONS. Chapter 2 contains service upon receipt, initial receipt, receipt of used parachute assembly, and preventive maintenance checks and services information and instructions.

CHAPTER 3 – UNIT MAINTENANCE INSTRUCTIONS. Chapter 3 contains maintenance procedures authorized at the unit level.

CHAPTER 4 – DIRECT SUPPORT MAINTENANCE INSTRUCTIONS. Chapter 4 provides maintenance procedures authorized at the direct support level.

CHAPTER 5 - SUPPORTING INFORMATION. Chapter 5 contains references, expendable and durable items list, maintenance allocation chart, repair parts and special tools list, national stock number index, part number index, and illustrated list of manufactured items.

REAR MATTER. Rear matter consists of alphabetical index, DA Form 2028, authentication page, and back cover.

Manual Organization and Page Numbering System. The manual is divided into five major chapters that detail the topics mentioned above. Within each chapter are work packages covering a wide range of topics. Each work package is numbered sequentially starting at page 1. The work package has its own page-numbering scheme and is independent of the page numbering used by other work packages. Each page of a work package has a page number of the for XXXX YY-ZZ where XXXX is the work package number (e.g. 0010 is work package 10), YY is the revision number for that work package, and ZZ represents the number of the page within that work package. A page number such as 0010 00-1/(2 blank) means that page 1 contains information but page 2 of that work package has been intentionally left blank.

Finding Information. The table of contents permits the reader to find information in the manual quickly. The reader should start here first when looking for a specific topic. The table of contents lists the topics contained within each chapter and the work package sequence number where it can be found.

Example: If the reader were looking for instructions on Patching Radial Seam which is a unit maintenance topic, the table of contents indicates that unit maintenance information can be found in chapter 3. Scanning down the listings for chapter 3, Radial Seam information can be found in WP 0019 00 (Work Package 19).

An Alphabetical Index can be found at the back of the manual; specific topics are listed with the corresponding work package number.

THIS PAGE INTENTIONALLY LEFT BLANK

CHAPTER 1
INTRODUCTORY INFORMATION
FOR
MC1-1C TROOP BACK PARACHUTE ASSEMBLY
MC1-1D TROOP BACK PARACHUTE ASSEMBLY

THIS PAGE INTENTIONALLY LEFT BLANK

MC1-1C/MC1-1D TROOP BACK PARACHUTE ASSEMBLY GENERAL INFORMATION

SCOPE

This Technical Manual provides Unit and Direct Support (DS) maintenance instructions for parachutes, NSN 1670-01-262-2359, and NSN 1670-01-487-0777. These are 35-Foot Diameter Troop Back Parachutes. This manual also provides a Repair Parts and Special Tools List, located in WP 0043 00 through WP 0050 00.

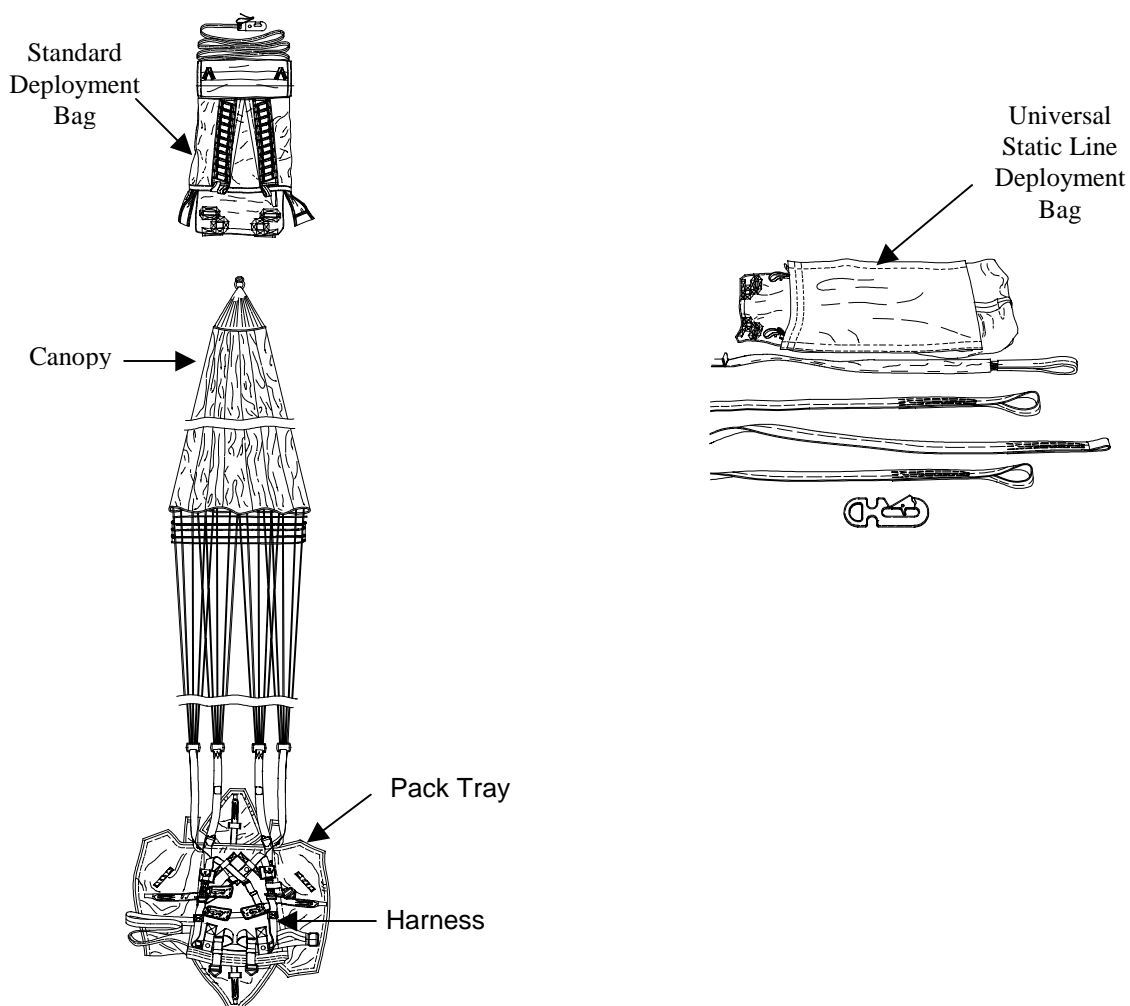

Equipment Name. MC1-1C Troop Back Parachute Assembly, 35-Foot Diameter, and MC1-1D Troop Back Parachute Assembly, 35-Foot Diameter.

Purpose of Equipment. The parachute provides capability to safely deliver an airborne soldier, and individual equipment, from an aircraft in flight, for a vertical assault on an enemy.

MAINTENANCE FORMS, RECORDS, AND REPORTS

Department of the Army forms and procedures used for equipment maintenance will be those prescribed by DA PAM 738-750, The Army Maintenance Management System. Maintenance forms and records used by Marine Corps personnel are prescribed by TM 4700-15/1.

REPORTING EQUIPMENT IMPROVEMENT RECOMMENDATIONS (EIR)

If your MC1-1C/MC1-1D Troop Back Parachute Assembly, needs improvement, let us know. Send us an EIR. You, the user, are the only one who can tell us what you don't like about your equipment. Let us know why you don't like the design or performance. Put it on an SF 368 (Product Quality Deficiency Report). Mail it to: Commander U.S. Army Soldier and Biological Chemical Command; ATTN: AMSSB-RIM-E(N), Kansas St., Natick, MA, 01760-5052. Navy submit NAVSEA Form 4160/1 (Rev 2-99) to Commander, NSDSA Code 5E30, NAVSURFCENDIV, 4363 Missile Way, Port Hueneme, CA 93043-4307. A reply will be furnished to you.

CORROSION PREVENTION AND CONTROL (CPC)

Corrosion Prevention and Control (CPC) of Army materiel is a continuing concern. It is important that any corrosion problems with this item be reported so that the problem can be corrected and improvements can be made to prevent the problem in future items.

While corrosion is typically associated with rusting of metals, it can also include deterioration of other materials, such as rubber and plastic. Unusual cracking, softening, swelling, or breaking of these materials may be a corrosion problem.

If a corrosion problem is identified, it can be reported using Standard Form SF 368, Product Quality Deficiency Report. Use of keywords such as "corrosion," "rust," "deterioration," or "cracking" will ensure that the information is identified as a CPC problem.

The form should be submitted to the address specified in DA PAM 738-750, Functional Users Manual for the Army Maintenance Management System (TAMMS).

DESTRUCTION OF ARMY MATERIEL TO PREVENT ENEMY USE**GENERAL INFORMATION:**

Objective. Methods of destruction used to inflict damage on air delivery equipment should make it impossible to restore equipment to a usable-condition in a combat zone, by either repair or cannibalization.

Authority. Destruction of air delivery equipment that is in imminent danger of capture by an enemy is a command decision that must be made by a battalion or higher commander, or the equivalent.

Implementation plan. All units that possess air delivery equipment should have a plan for the implementation of destruction procedures.

Training. All personnel who use or perform such functions as rigging, packing, maintenance, or storage of air delivery equipment, should receive thorough training on air delivery equipment destruction procedures and methods. The destruction methods demonstrated during training should be simulated. Upon completion of training, all applicable personnel should be thoroughly familiar with air delivery equipment destruction methods and be capable of performing destruction without immediate reference to any publication.

SPECIFIC METHODS:

Specific methods of destroying Army materiel to prevent enemy use shall be by mechanical means, fire or by use of natural surroundings.

Destruction by Mechanical Means. Air delivery equipment metal assemblies, parts, and packing aids shall be destroyed using hammers, bolt cutters, files, hacksaws, drills, screwdrivers, crowbars, or other similar devices used to smash, break, bend or cut.

WARNING

Exercise extreme care when using petroleum products to destroy equipment by fire, as these materials are highly flammable. Improper handling may cause injury to personnel.

Destruction by Fire. Items that can be destroyed by fire shall be burned. The destruction of equipment by use of fire is an effective method of destroying low-melting-point metal items (e.g., side rails, threaded portions of nuts and bolts, and platforms). However, mechanical destruction should be completed first, whenever possible, before initiating destruction by fire. When items to be destroyed are made of metal, textile materials (or some comparable low combustible material) should be packed under and around the items, then soaked with a flammable petroleum product and ignited. Proper concentration of equipment that is suitable for burning will provide a hotter and more destructive fire.

Destruction by Use of Natural Surroundings. Small vital parts of assemblies, that are easily accessible, may be disposed of as follows: Disposal or denial of equipment to an enemy may be accomplished through use of natural surroundings. Accessible vital parts of assemblies may be removed and scattered through dense foliage, buried in dirt or sand, or thrown into a lake, stream, or other body of water. Total submersion of equipment in a body of water will provide water damage as well as concealment. Salt water will inflict extensive damage to air delivery equipment.

PREPARATION FOR STORAGE AND SHIPMENT

For storage and shipment, refer to TM 10-1670-201-23/T.O. 13C-1-41/NAVAIR 13-1-17, and WP 0039 00; for shipment, refer to WP 0040 00 of this manual.

WARRANTY INFORMATION

The MC1-1C/MC1-1D Troop Back Parachute Assembly does not contain warranty provisions.

NOMENCLATURE CROSS-REFERENCE LIST

| Common Name | Official Nomenclature |
|-------------|--|
| MC1-1C | MC1-1C Troop Back Parachute Assembly, 35-Foot Diameter |
| MC1-1D | MC1-1D Troop Back Parachute Assembly, 35-Foot Diameter |
| USL | Universal Static Line |

LIST OF ACRONYMS AND ABBREVIATIONS

| | |
|-------|---------------------------------------|
| BER | Beyond Economic Repair |
| BOI | Basis of Issue |
| CAGEC | Commercial and Government Entity Code |
| Cm. | Centimeter |

LIST OF ACRONYMS AND ABBREVIATIONS – Continued

| | |
|------|--|
| CPC | Corrosion Prevention and Control |
| DA | Department of the Army |
| DS | Direct Support |
| Dtd. | Dated |
| EA | Each |
| EIR | Equipment Improvement Recommendation |
| EDS | Electrostatic Discharge Sensitive |
| F | Fahrenheit |
| FSCM | Federal Supply Code for Manufacturer |
| FSC | Federal Supply Classification |
| ft. | Feet |
| in. | Inches |
| Ltrs | Liters |
| LG | Long |
| Lbs | Pounds |
| MAC | Maintenance Allocation Chart |
| MTOE | Modified Table of Organization and Equipment |
| MTG | Mounting |
| MWO | Modification Work Order |
| NF | National Fine (Thread) |
| NIIN | National Item Identification Number |
| No. | Number |
| NSN | National Stock Number |
| OD | Olive Drab |
| oz. | Ounces |
| PMCS | Preventive Maintenance Checks and Services |
| PQDR | Product Quality Deficiency Report |

LIST OF ACRONYMS AND ABBREVIATIONS – Continued

| | |
|-------|---|
| psi. | Pounds per square inch |
| RPSTL | Repair Parts and Special Tools List |
| SMR | Source, Maintenance and Recoverability |
| TAMMS | The Army Maintenance Management System |
| TB | Technical Bulletin |
| TMDE | Test Measurement and Diagnostic Equipment |
| UOC | Usable on Code |
| USL | Universal Static Line |
| WP | Work Package |

SAFETY, CARE AND HANDLING

The following subparagraphs summarize the safety, care and handling requirements for the parachute assembly.

Safety. Use care in handling packed parachutes as exposed metal parts could cause painful injuries.

Care and Handling. Every effort shall be made to protect the parachute from weather elements, dust, dirt, oil, grease, and acid. An unpacked parachute shall be placed in an aviator kit bag. When available, an environmentally controlled building should be used to store parachutes. Parachutes shall be stored in a dry, well-ventilated location and protected from pilferage, dampness, fire, dirt, insects, rodents, and direct sunlight.

COMMON TOOLS AND EQUIPMENT

For authorized common tools and equipment, refer to the Modified Table of Organization and Equipment (MTOE) applicable to your unit.

SPECIAL TOOLS, TEST MEASUREMENT AND DIAGNOSTIC EQUIPMENT (TMDE), AND SUPPORT EQUIPMENT

Special tools, TMDE and support equipment are not required.

REPAIR PARTS AND SPECIAL TOOLS LIST (RPSTL)

Repair parts are listed and illustrated in WP 0043 00 through WP 0051 00 of this manual.

END OF WORK PACKAGE

THIS PAGE INTENTIONALLY LEFT BLANK

**MC1-1C/MC1-1D TROOP BACK PARACHUTE ASSEMBLY
EQUIPMENT DESCRIPTION AND DATA**

EQUIPMENT CHARACTERISTICS, CAPABILITIES AND FEATURES

A summary of the characteristics, capabilities and features of the equipment is contained in the following subparagraphs:

Characteristics. Provides a capability to deliver an airborne soldier, and individual equipment, from an aircraft in flight, for a vertical assault on the enemy.

Capabilities and Features:

Limited in operation to winds of 13-knots at surface.

Capable of supporting 360-pounds.

Highly portable.

Complete assembly weight: 29-pounds.

Components of the system: Canopy assembly. Deployment bag. Pack tray. Harness assembly. Risers. Universal Static Line.

LOCATION AND DESCRIPTION OF MAJOR COMPONENTS

The following subparagraphs contain locations and descriptions of major components.

Canopy. The MC1-1C/MC1-1D parachute canopy has a 3³/₄-inch mesh anti-inversion net attached to the skirt of the canopy. The net extends 18-inches below the canopy skirt. The canopy has two vent line centering loops and an orifice cut out to give forward movement for directional control.

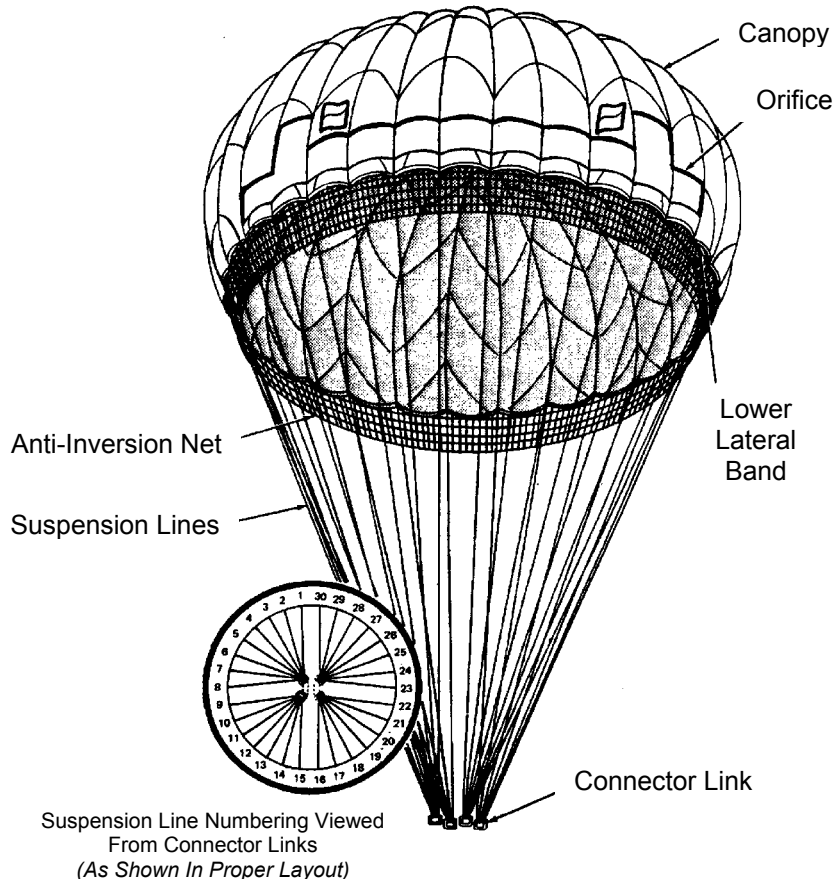

Pack Tray. The pack tray holds the MC1-1C/MC1-1D parachute, packed in the deployment bag, to the parachute harness. It is constructed of 7.25-ounce nylon duck. The waistband is located near the bottom of the pack tray.

NOTE

Waistband extension may be required.

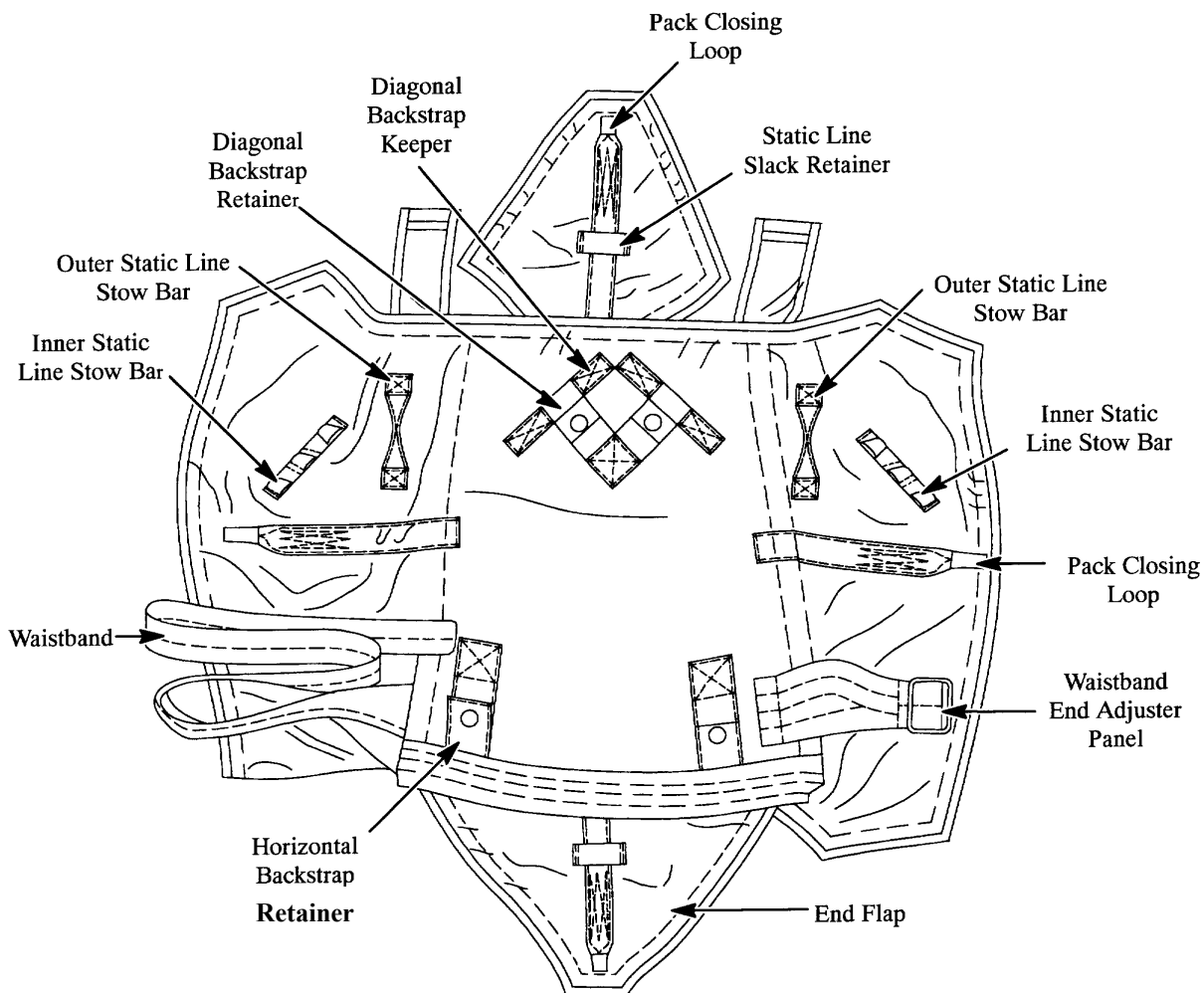

NOTE

The U.S Navy is authorized to use an alternate Deployment Bag (P/N 56D6276-4).

Deployment Bag. The MC1-1C/MC1-1D parachute is packed in the deployment bag. The deployment bag is constructed of 8.2-ounce cotton sateen cloth. These bags differ in the attachment of a static line, standard (A) and Universal Static Line (USL) (B).

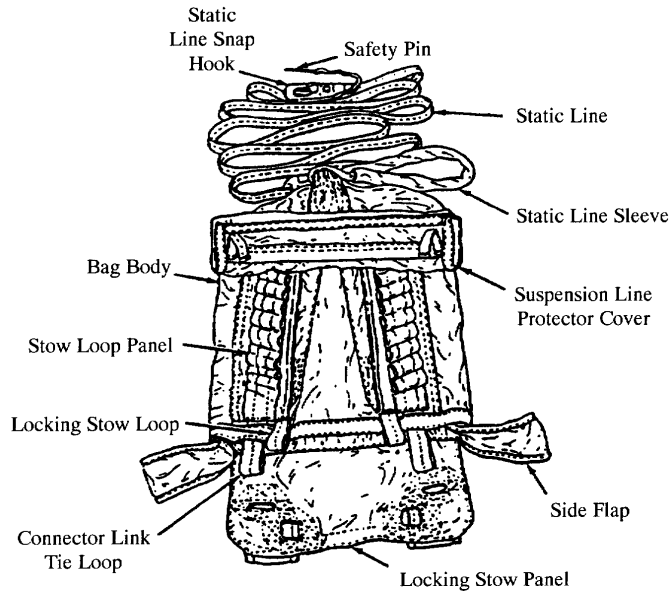

(A) Standard Deployment Bag

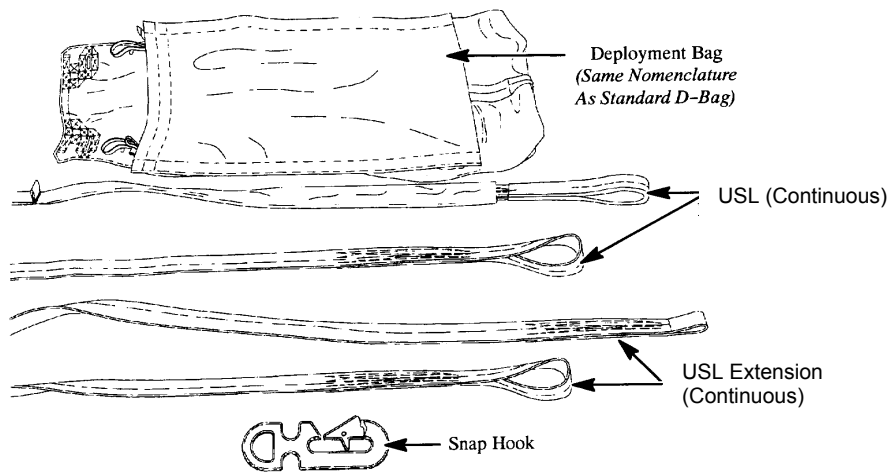

(B) Universal Static Line Deployment Bag

Harness Assembly. The parachute is attached to the harness assembly, which secures the parachute to the paratrooper before the jump and during the descent. The MC1-1C/MC1-1D parachute harness assembly is equipped with one chest and two leg straps, and secured with quick-ejector snaps. The female portion of the MC1-1C/MC1-1D canopy release has a cable loop-type release. There are three ejector snap pads for the ejector snaps. There are two canopy release pads for the canopy release. The MC1-1C/MC1-1D harness also has two D-rings and two equipment rings. The MC1-1C/MC1-1D harness also has two D-rings and two equipment rings.

NOTE

The troop harness assembly, equipped with equipment rings, will replace the MC1-1C/MC1-1D parachute harness assembly through attrition. Also, the nylon pack tray, with waistband located in the lower position, will replace the cotton and nylon pack trays, with waistband located in the center of the pack tray, through attrition. During the transition period, numerous configurations may occur. Interchangeability of components is permitted, provided shelf service life and serviceability criteria are met.

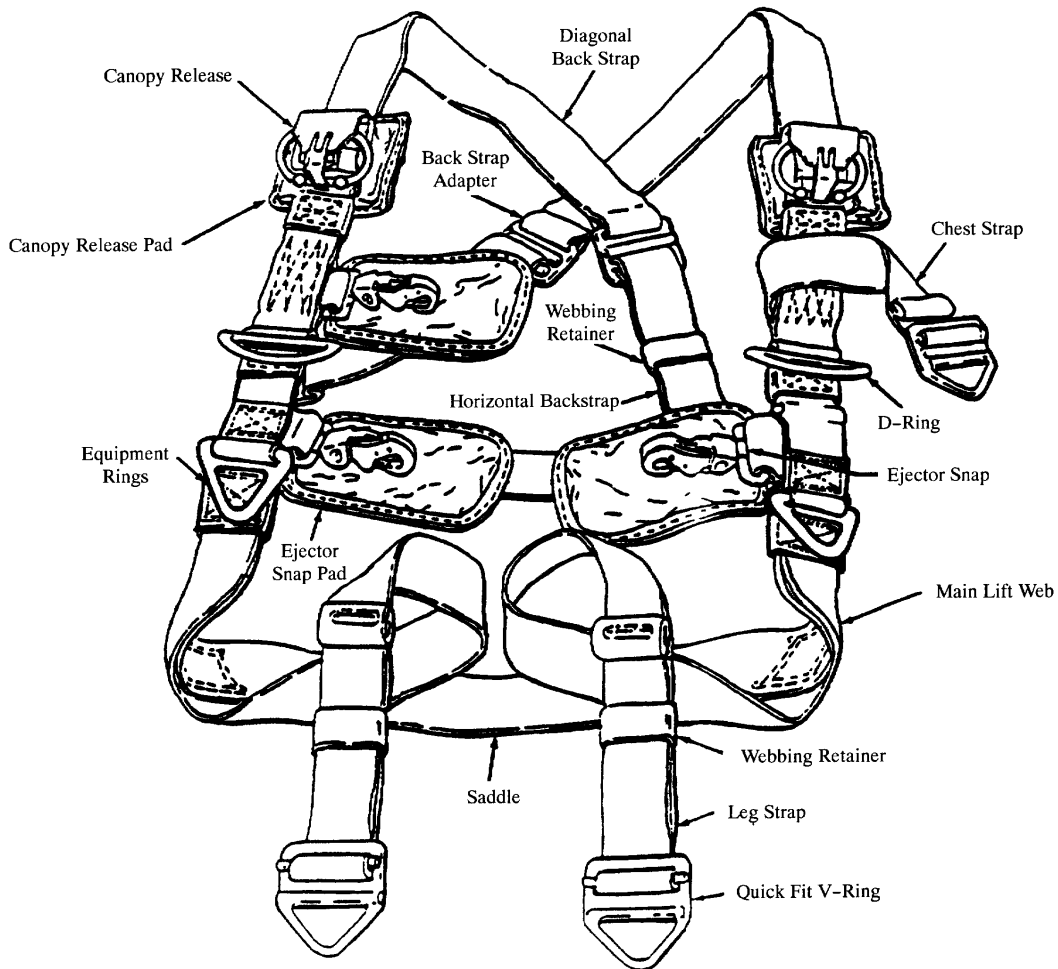

Riser Assembly. Each of the two riser assemblies is 30-inches long (finished length) and constructed of type XIII nylon webbing, with the male canopy release fitting permanently attached. The two ends of each riser are attached to the suspension line connector links.

NOTE

The standard MC1-1C/MC1-1D riser assembly will be marked to assist in item identification, using the procedure described in WP 004 00.

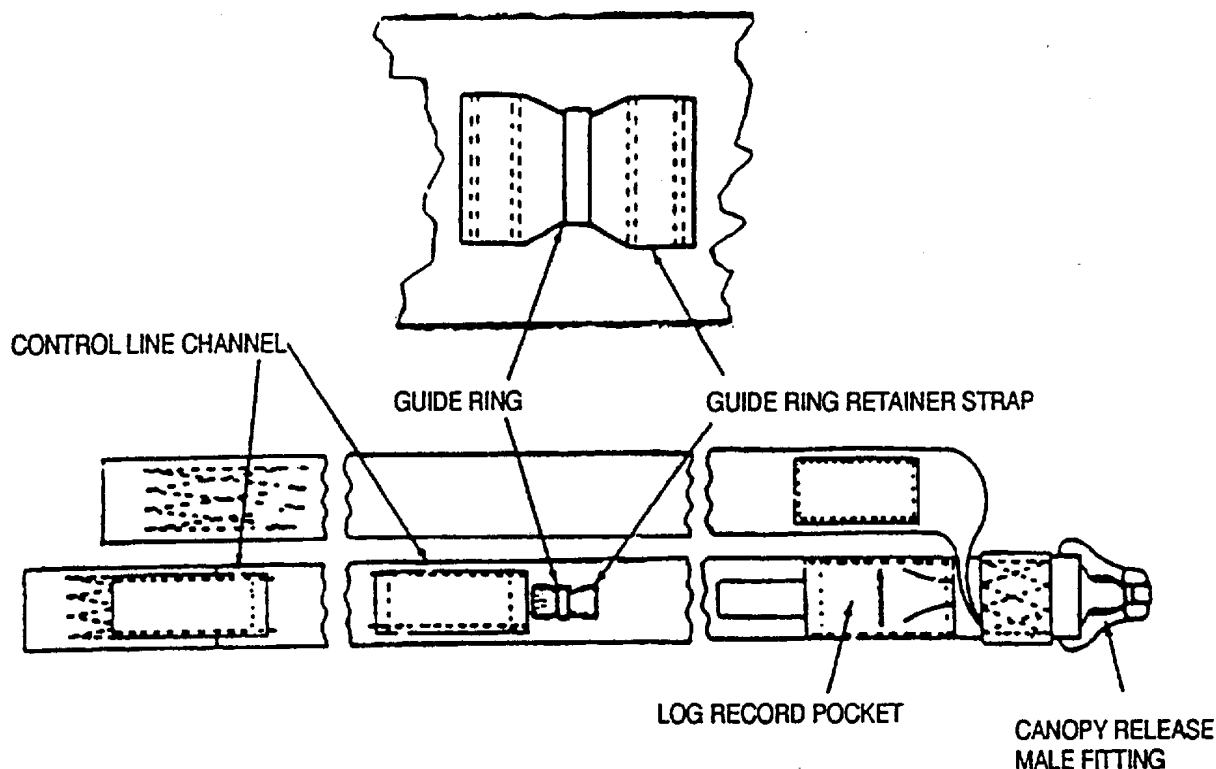

EQUIPMENT DATA

The following list summarizes the specific capabilities and limitations of the equipment, and other critical data needed by the unit and direct support (DS) maintenance personnel for maintenance of the MC1-1C/MC1-1D Troop Back Parachute Assembly.

Weight (packed for airdrop) 29-lbs. (approx.)

CANOPY ASSEMBLY

| | |
|-------------------------------------|---|
| Shape | Parabolic |
| Diameter (nominal) | 35-feet |
| Diameter of skirt | 24.5-feet |
| No. of gores | 30 |
| No. of sections per gore | 4 or 5 |
| Gore material | Cloth, parachute, low porosity, type I |
| No. of radial tapes | 30 |
| No. of control lines | 2 |
| No. of control line bridles | 2 |
| Control line material | Type II, nylon cord |
| Control line bridle material | Type II, nylon cord |
| Control line toggle material | $\frac{5}{8}$ -in. diameter, hardwood dowel |
| Control line guide ring | Reefing ring (PS27762-1) |
| Guide ring retaining strap material | $\frac{9}{16}$ -in. wide, type I, nylon webbing |
| Orifice | 100.04 sq. ft. (perimeter) |
| Radial tape material | $\frac{9}{16}$ -in., type I nylon webbing |
| No. of vent lines | 15 |
| Vent line material | Type II, nylon cord |
| No. of suspension lines | 30 |
| Suspension line material | Type II, nylon cord |
| No. of V-tabs | 30 |
| No. of pocket bands | 15 |
| No. of connector links | 4 L-bar |
| Anti-inversion net | $3\frac{3}{4}$ -in. mesh |

PACK TRAY

| | |
|----------------|----------------------|
| Panel material | Nylon duck, 7.25-oz. |
|----------------|----------------------|

HARNESS ASSEMBLY

| | |
|----------------|--------------------------|
| Strap material | Type XIII, nylon webbing |
|----------------|--------------------------|

DEPLOYMENT BAG

Bag material 8.2-oz. Cotton sateen cloth

RISER ASSEMBLIES (2)

Material Type XIII, nylon webbing

Length 30-in.

UNIVERSAL STATIC LINE

Material Tube edge

Lengths 5-feet 10-inches ($\pm \frac{1}{2}$ -inch)
and 14-feet 10-inches (± 1 -inch)

UNIVERSAL STATIC LINE SNAP HOOK (1)

Material Chromium Molybdenum

Length 6-inches

END OF WORK PACKAGE

THIS PAGE INTENTIONALLY LEFT BLANK

CHAPTER 2

**OPERATOR MAINTENANCE INSTRUCTIONS
FOR
MC1-1C TROOP BACK PARACHUTE ASSEMBLY
MC1-1D TROOP BACK PARACHUTE ASSEMBLY**

THIS PAGE INTENTIONALLY LEFT BLANK

**MC1-1C/MC1-1D TROOP BACK PARACHUTE ASSEMBLY
SERVICE UPON RECEIPT**

THIS TASK COVERS:

- Overview
 - Initial Receipt
 - Receipt of Used Parachute
 - After-Use Receipt
-

INITIAL SETUP:**Materials/Parts**

Tape Lacing and Tying (Item 38, WP 0055 00)

Personnel Required

92R (10) Parachute Rigger

Tools

Needle, Tacking (Item 19, WP 0042 00)

Equipment Condition

All equipment shall be serviceable and ready for use.

OVERVIEW

This chapter contains information necessary to maintain the MC1-1C/MC1-1D Troop Back Parachute, on the unit and direct support maintenance levels, in accordance with the Maintenance Allocation Chart (MAC) for the equipment. It includes the following:

1. Procedures for processing a new or used parachute assembly upon receipt.
2. Assembly of components prior to packing.
3. Preventive maintenance procedures to ensure continued serviceability of all components.
4. As required inspections and maintenance procedures performed prior to packing, such as shakeout and airing, and cleaning and drying, and acidity and salt-water contamination tests.
5. Detailed packing procedure.
6. Repair methods and repair, or replacement, procedures for all components of the parachute assembly.

INITIAL RECEIPT

The following describes the procedures for processing parachutes upon initial receipt.

General Procedures for Air Delivery Equipment. When air delivery equipment is initially procured from a supply source and issued to a using unit, the item(s) will be unpacked from the shipping container(s) and inspected by a qualified parachute rigger (MOS 92R). The inspection performed will be a technical/rigger-type inspection and will be conducted as outlined in the Preventive Maintenance Checks and Services (PMCS) procedures. Upon completion of the inspection, the item(s) will be tagged as prescribed in DA PAM 738-751. Serviceable equipment may then be entered either into storage or into use in airdrop operations, as applicable. An unserviceable item will be held and reported, in accordance with DA PAM 738-750/ MCO 4855.10B.

Inspection Personnel. Personnel other than parachute rigger personnel may assist in the unpacking process of initially received parachutes, as directed by the local air delivery equipment maintenance officer. However, the maintenance officer will ensure the entire unpacking effort is conducted under the direct supervision of a qualified rigger (MOS 92R).

Configuration Condition. Acceptance of new equipment from the manufacturer is based upon inspections made of sample lots that have been randomly selected in accordance with military standards. It is incumbent upon the using activity personnel to bear this in mind whenever equipment is first placed in service. Changes will sometimes evolve from the original equipment design and sometimes contractors are authorized deviations in material and construction techniques. Air delivery equipment that has been in the field cannot be expected to meet exacting manufacturing specifications; however, the equipment should closely reflect desired design characteristics. Since repairs, modifications, and/or changes can alter or detract from the configuration originally desired, such equipment shall be airworthy, safe, of the desired configuration, and adequate for intended use.

Marking Parachutes. Prior to being placed into service, personnel parachutes that have had no previous use will be marked to reflect the date of entry into service. The marking will be made on the canopy information data block by stenciling the lettering in ½-inch characters, using the marking and restenciling repair procedures detailed in WP 0014 00. Other applicable parachute components will be marked adjacent to existing data. The stenciled data will appear on IN-SVC followed by the date, which will indicate the month and calendar year, such as "Jan. 85". Ensure the added marking does not infringe upon, or obliterate, any original data on the information data block.

Marking Risers. Prior to being placed into service, the risers will be marked to reflect placed in service and identified as a MC1-1C/MC1-1D. Mark each riser with two turns blue; ½-inch pressure sensitive adhesive tape, around each riser assembly, centered on the confluence wrap.

Position Control Lines. For new MC1-1C/MC1-1D parachutes being placed in-service and in-serviced parachutes with less than six jumps, position control lines as follows:

1. Trace each control line bridle and the attached control line from the point of attachment to the canopy to the free-end of the control line.
2. Pass the control line free-end from the top, through the channel guide ring (located on the inside of each rear riser), and further past the control line free-end, through a wood toggle. (Refer to WP 0026 00 for toggle construction details, if required).
3. Position the toggle against the bottom of the guide ring and, while holding the toggle in position, pull the control line free-end taut until the control line tension equals that of the suspension lines. Move each toggle three inches from the channel guide ring. While holding each control line in position, place one-inch wide masking tape on the control line just above the toggle, wrapping the tape around the riser once. Do not remove this tape.
4. Make two overhand knots in each control line against the bottom of each toggle. The remaining free end of each control line from the second overhand knot is to measure five inches. Then make the third overhand knot in the free end. Trim the control line free end at a point ½-inch below the third overhand knot.
5. For parachutes with more than five jumps, position the control line toggles according to the following procedure.
 - a. Undo the three overhand knots in each control line free end.
 - b. Pull both control line free ends until control line tension equals that of the suspension lines.
 - c. Follow the procedures given in WP 0026 00.
6. Annotation will be made in the note section of the parachute log record that the control line toggle adjustment procedure has been performed.

Parachute Log Record. The Army Parachute Log Record, DA Form 3912, AFTO 391, and NAVWPNCEN or NAWCWPNS CL 13512/11 (Premeditated Parachute Record) are history-type maintenance documents that accompany the parachute canopy and pack tray assemblies through the period of service of the individual assembly. The log record provides a means of recording maintenance actions performed on a parachute canopy assembly. Normally, a log record is initiated and attached to a pack tray upon receipt by a using unit. However, if the item is subjected to alteration or modification by a maintenance activity during the interim period from date of manufacture to receipt by a using unit, the log record will be prepared by the activity performing the maintenance function. Once initiated, a log record will be attached to, and contained in, an affixed parachute log record/ inspection data pocket, until such time as the parachute canopy assembly is destroyed or rendered unfit for further use or repair.

Additionally, should an item that requires a log record, be transferred from one unit to another, the log record for the parachute assembly will accompany the item in the transfer action. A prepared log record will not be removed or separated from a parachute, and especially a packed parachute, except as directed by the local air delivery equipment maintenance activity officer.

A log record that is illegible, lost, damaged, soiled, or precludes further entries due to lack of space, will be replaced upon the next repack or inspection, as applicable, with a serviceable item from stock.

Installing Attaching Tie.

Install attaching tie as follows:

1. Cut a 30-inch length of tape, lacing and tying (super tack), and double the lacing length.
2. Pass the looped end, of the doubled lacing length, around the centerfold of the log record and form a slip loop on the outside, at the log record top.

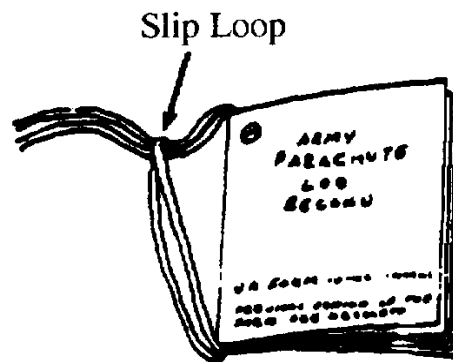

Forming Slip Loop On Log Record Outside

3. Pass the lacing length running ends through the corner attaching hold, from the front cover of the log record.

Corner Attaching Hole



Passing Lacing Loose Ends Through Corner Attaching Hole

4. Ensure the running ends are routed over that part of the lacing length located along the log record centerfold.

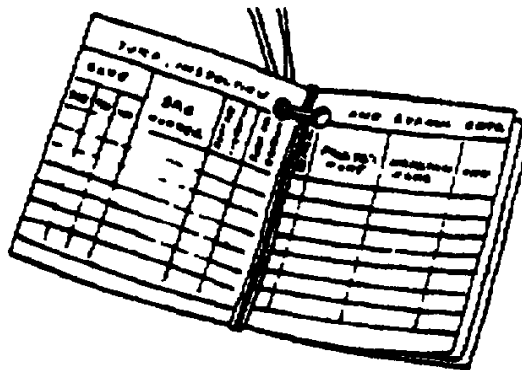

Routing Lacing Loose End Through Log Record Centerfold

5. Complete the attachment tie by making a half hitch on top of the slip loop made in 2., above.
6. Thread one running end of the log record attachment tie in a tacking needle and pass the tacking needle, with attached end, through the edge binding of the applicable parachute log record/ inspection data pocket.

- Remove the lacing end from the tacking needle; make a finished 10-inch-long log record attaching loop by securing the two lacing ends together with an overhand knot.

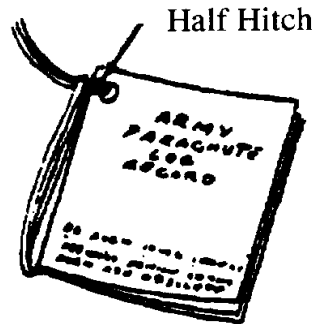

Log Record Attachment Tie Completed

- Insert the log record into the pocket and secure the record within the pocket using the pocket flap and applicable type flap fastener.

Accomplishing a Log Record. Upon completion of the first technical/ rigger-type inspection, the individual performing the inspection will initially prepare a log record for an individual parachute, or applicable type parachute harness, and accomplish subsequent record entries using the following procedures:

NOTE

Log record book entries will be made with a suitable type blue or black marking device that cannot be erased (no felt tip markers).

- Inside Front Cover.* Using the information provided on the parachute canopy data block, make the following entries on the inside front cover of the log record. Entries may be continued on the inside of the back cover, if necessary.

| | |
|---|---|
| SERIAL NO. | ○ |
| TYPE | |
| PART NO. | |
| DATE OF MFG. (Month & Year) | |
| MANUFACTURER | |
| CANOPY CONTRACT NO. | |
| STATION & UNIT | |
| | |
| | |
| | |
| <i>(Continued on inside back cover)</i> | |

NOTE

A parachute canopy serial number is recorded in a log record as a method of establishing control for maintenance, Equipment Improvement Report (EIR) and Product Quality Deficiency Report (PQDR) documentation, and to ensure the correct original record is reattached should the record become detached. A canopy serial number will not be used for property accountability, except in test projects or other special instances.

- a. *Serial Number.* Enter the parachute canopy assembly serial number.
 - b. *Type.* Enter the parachute type.
 - c. *Part number.* Enter the part number of the parachute canopy.
 - d. *Date of Manufacture.* Enter the month and year the parachute canopy was manufactured.
 - e. *Manufacturer.* Enter the name of the parachute canopy manufacturer.
 - f. *Canopy Contract Number.* Enter the entire contract number specified for the parachute canopy.
 - g. *Station and Unit.* Enter the name of the station and unit to which the parachute canopy is currently assigned. When a parachute is transferred permanently to another station, and/ or unit, the original entry will be lined out and the name of the receiving station, and/ or unit, will be entered.
2. *Inside Back Cover.* Entries may be continued on the inside back cover, if necessary.

The form is a rectangular box with a circular hole in the top-left corner. The title "STATION & UNIT (Continued)" is printed in the top right. Below the title are ten horizontal lines for writing.

3. *Modification Work Order (MWO) Compliance Record Page.* When a modification is performed on a parachute canopy, the following entries will be made on the Modification Work Order Compliance Record pages of the log record, as follows:

- a. *MWO Number.* Enter the publication number and date of the MWO that describes the MWO (1, illustration below).

| Modification Work Order | | Compliance Record | | | | | |
|-------------------------------------|-------------------------------|--------------------|---------|-------|------|-----|-----|
| MWO Number | MWO Title | Modified By (Name) | INSP By | UNIT | Date | | |
| | | | | | Day | MO. | YR. |
| ① 10-1670-292-23&P 15 JULY 01 | STATIC LINE STOW MODIFICATION | VORUKAT | TRK | 58300 | 24 | 3 | 00 |
| ② 10-1670-292-23&P 15 JULY 01 | STATIC LINE STOW MODIFICATION | C/W | TRK | 58300 | 24 | 6 | 01 |
| | | | | | | | |
| | | | | | | | |
| | | | | | | | |

- 1. Modification Work Order Compliance Completed.
- 2. Modification Completed By Unknown Due To Lost Original Log Record.

- b. *MWO Title.* Enter a short, abbreviated title extracted from the MWO prescribing the work.
 - c. *Modified by.* Enter the last name of the individual who has performed the modification. If the original log record for the parachute has been lost, and it has been ascertained through inspection that a particular modification has been accomplished, the entry for this column will be C/W, complied with, which signifies the applicable MWO has been complied with.
 - d. *Inspected by.* The individual who accomplished the inspection, required after modification, will sign this entry with last name only.
 - e. *Unit.* Enter the unit designation responsible for performing the MWO or, in the event of a lost log record, the unit to which the inspector is assigned.
 - f. *Date.* Enter the day, month, and year the modification work was completed.
4. *Unit and Direct Support Repair and Inspection Data.* When a parachute canopy assembly is initially received from a supply source, and a technical/rigger-type inspection is performed, the inspection accomplishment will be documented on the Unit and Intermediate Repair and Inspection Data page of the individual parachute log record. Additional entries will also be made on this page each time the canopy assembly is repaired, or is administered an inspection, in compliance with a one-time inspection Technical Bulletin (TB). The page completion criteria are as follows:
- a. *Type of repair.* Enter the type of repair, completion of initial inspection, repair accomplishment, and technical bulletin inspection compliance.
 - b. *Inspection by.* The individual, who accomplished the inspection required, will sign this entry with last name.
 - c. *Unit.* Enter the unit designation responsible for performing the type of repair.

d. *Date.* Enter the day, month, and year the repair was performed.

| Unit & Direct Support | | Repair & Inspection Data | | | |
|-------------------------------|----------|--------------------------|------|----|----|
| Type of Repair | Insp. By | Unit | Date | | |
| | | | Day | MO | YR |
| 1. Initial Inspection | Yenckus | SBCCOM | 12 | 2 | 01 |
| 2. 1 Sec and 4 Lines replaced | Gravel | SBCCOM | 3 | 3 | 01 |
| 3. TB 10-1670-213-20/5 | Burton | SBCCOM | 10 | 4 | 01 |
| | | | | | |
| | | | | | |

1. Completion Of Initial Inspection.
2. Repair Accomplishment.
3. Technical Bulletin Inspection Compliance.

5. *Note page.* A page is provided at the back of a parachute log record to accommodate recording additional data pertinent to the serviceability of a parachute canopy assembly. This shall also include the month and year the item was placed in service.

NOTES

RISER MFG DATE: JAN '86
 PLACED IN SERVICE: MAR '86
 IMMERSSED IN SALT WATER: 26/10/86
 RINSED 27/10/86

NOTE

A parachute log record that is completely filled out, lost, illegible, or in an otherwise unserviceable condition, will be replaced with a serviceable log record.

6. *Replacing a filled out or unserviceable log record.*
 - a. Using a suitable blue or black marking device, enter NEW BOOK on the outside front cover of the replacement log record.
 - b. Transcribe the information from the inside front cover of the original log record to the inside front cover of the replacement log record. If the original data is illegible or missing, use the canopy information data block to collect the required data.

- c. In the replacement log record; transcribe the initial and last entry made on the Jump, Inspection, and Repack Data page of the original log record.
- d. Transcribe all data from the remaining pages of the original log record; to the appropriate pages of the replacement log record.
- e. After all original data has been transcribed destroy the original log record.

7. *Replacing a lost log record.*

NOTE

Any time a log record is discovered missing from a parachute, a replacement log record will be initiated during repack or inspection, as applicable.

- a. Using a suitable blue or black marking device, enter NEW BOOK at the top of the inside front cover of the replacement log record.
- b. Accomplish the log record inside front cover as prescribed above.
- c. The age life of the canopy will be obtained from the date placed in service (initial) and other applicable data on the Jump, Inspection, and Repack Data page of the log record, as detailed above. Enter IN, if the date placed in service is known. If not known, enter UNK.
- d. If it can be ascertained by inspection that a previous MWO or TB has been complied with, applicable entries will be made on the appropriate page of the replacement log record.
- e. Attach the replacement log record to the log record/inspection data pocket using the procedures above.

RECEIPT OF USED PARACHUTE

Upon initial receipt of used parachute, proceed as follows:

1. Follow procedures given in the General Procedures for Air Delivery Equipment paragraph, above, and check each component for excessive wear and tear.
2. If defects or damages are discovered, process the parachute for maintenance at the maintenance level assigned by the Maintenance Allocation Chart (MAC), WP 0042 00.

AFTER-USE RECEIPT

When a parachute is received at the maintenance activity, following its use by the parachutist during air delivery, it must be given a shakeout and aired (WP 0007 00), and if necessary, cleaned (WP 0008 00) before it can be returned to service. If a parachute is issued but is not used, it does not need to be given a shakeout; however, it must be given a routine inspection by a qualified parachute rigger (MOS 92R).

END OF WORK PACKAGE

THIS PAGE INTENTIONALLY LEFT BLANK

MC1-1C/MC1-1D TROOP BACK PARACHUTE ASSEMBLY
ASSEMBLING THE MC1-1C/MC1-1D TROOP BACK PARACHUTE ASSEMBLY

THIS TASK COVERS:

- Assembly
-

INITIAL SETUP:**Materials/Parts**

Tape, Adhesive, Pressure Sensitive, Blue
(Item 37, WP 0055 00)

Equipment Condition

Parachute canopy in proper layout on packing table or other suitable surface.

Personnel Required

92R (10) Parachute Rigger

ASSEMBLY

Assembling the MC1-1C/MC1-1D Parachute. When the parachute is received from the supply activity, and before it is packed for use, the components must be assembled. This must be accomplished during the layout of the parachute (WP 0011 00). If, in assembling components, any component is found to be defective, the parachute must be processed for repair. Place the components on a packing table and obtain proper layout of the canopy assembly; then assemble components as follows:

1. *MC1-1C/MC1-1D Harness.* Attach the harness to the pack tray as follows:
 - a. Place the pack tray on the table, with back strap retainers and keepers up, and with the end flap containing the static line slack retainer toward the apex end of the table.
 - b. Attach the harness to the pack tray as illustrated in the figure below, by threading each of the pack tray diagonal back-strap-retainers through the harness diagonal back-strap-channels (for the required size), and under the back-strap keepers.

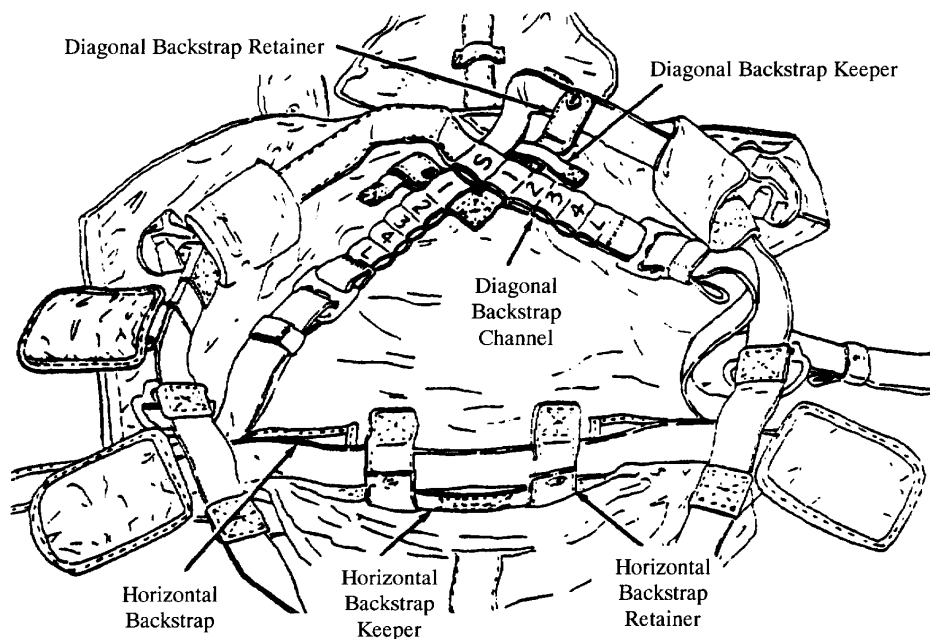

- c. Secure both pack tray horizontal back-strap-retainers over the horizontal back-strap, as illustrated on the previous page.
 - d. Secure the pull-dot snap fasteners.
2. Risers. Attach the risers to the MC1-1C/MC1-1D harness as follows:
- a. Lay the parachute harness down, with the female fittings of the harness near the male fittings of the risers.
 - b. Fit heel of male fitting into groove of female fitting.

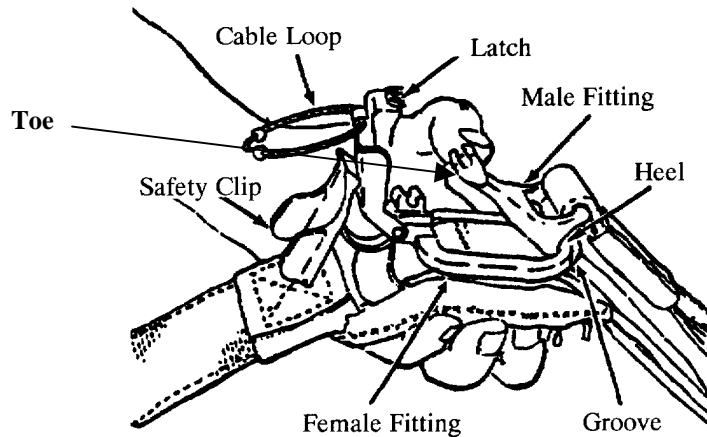

- c. Fit toe of male fitting into slot of female fitting, close latch, and ensure the latch is securely locked.

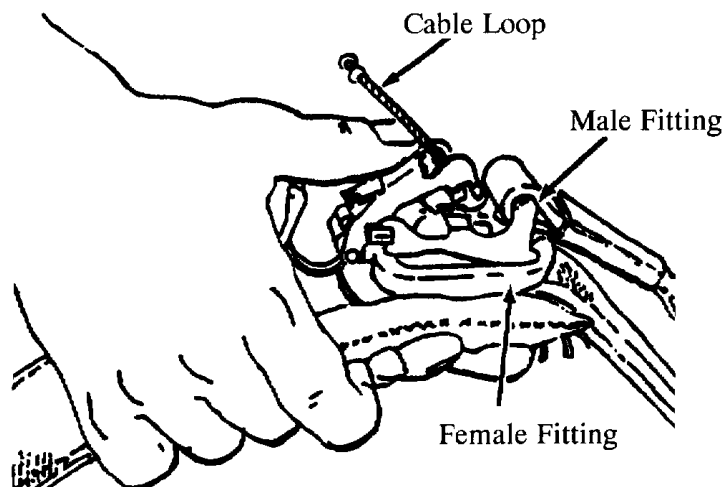

- d. Operate latch and check for smooth operation. Close and lock latch.

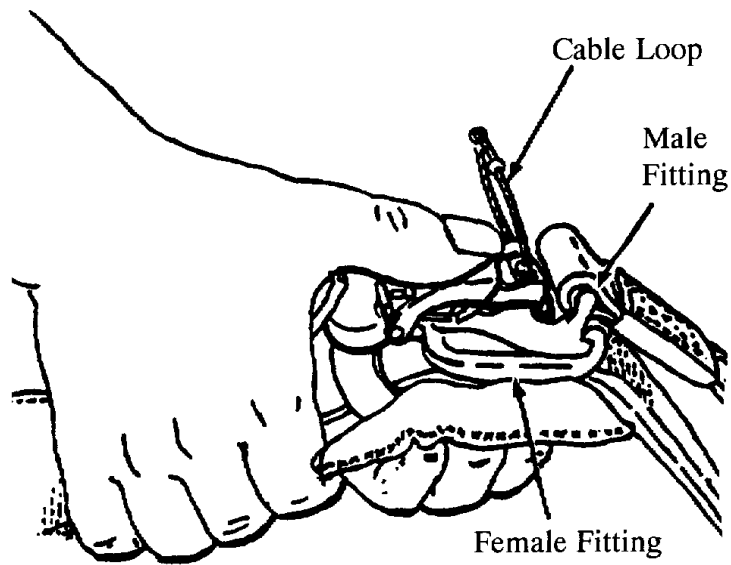

- e. Position the cable loop around the latch.

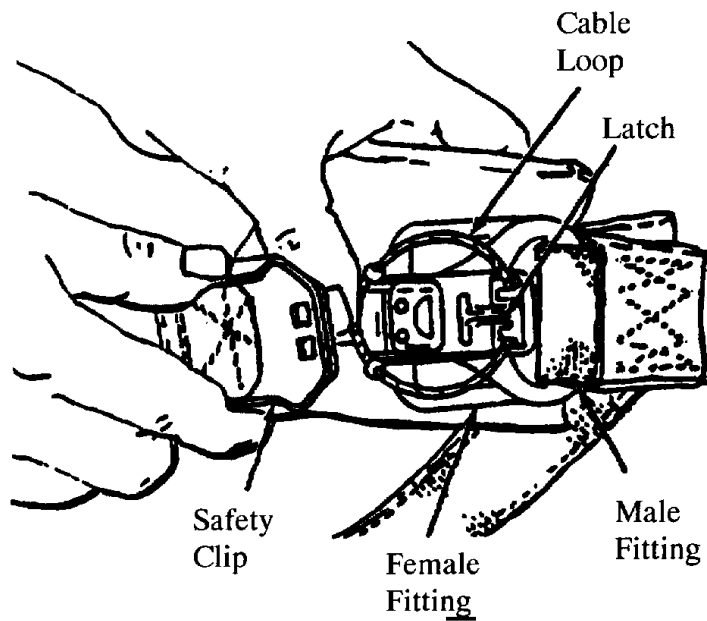

- f. Fit the heel of the safety clip into the slot of the latch.

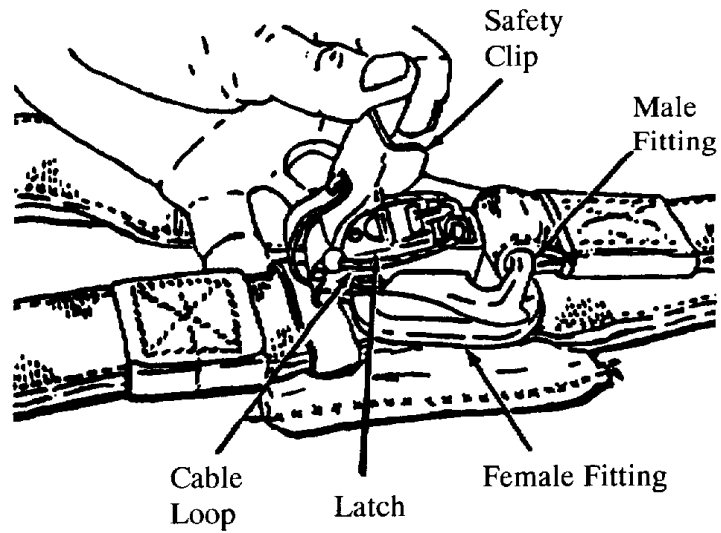

- g. Close the safety clip.

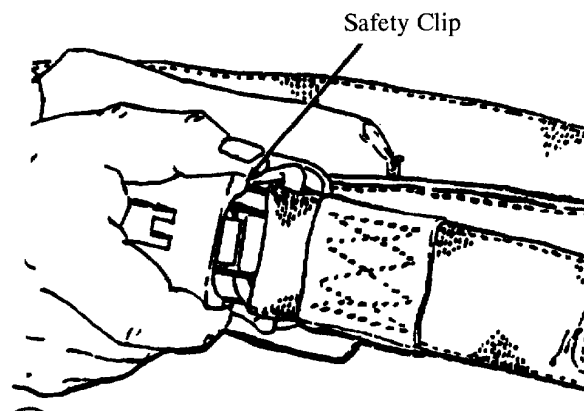

- h. If applicable, re-wrap risers utilizing 2 turns single, ½-inch blue pressure sensitive adhesive tape around the confluence wrap.

END OF WORK PACKAGE

**MC1-1C/MC1-1D TROOP BACK PARACHUTE ASSEMBLY
PREVENTIVE MAINTENANCE CHECKS AND SERVICES (PMCS), INTRODUCTION**

GENERAL

The following describe PMCS procedures on the unit and direct support levels. The PMCS table has been provided to ensure the MC1-1C/MC1-1D parachute is in proper operating condition, and ready for its primary mission.

SCOPE

The following work packages (WP 0007 00 through WP 0038 00) contain maintenance procedures that are the responsibility of the specified technician, as authorized by the Maintenance Allocation Chart (MAC), and the Source, Maintenance, and Recoverability (SMR) coded items that are identified in the Repair Parts and Special Tools List (RPSTL).

MAINTENANCE FUNCTIONS/PROCEDURES

Each of the mentioned work packages above identifies a maintenance function specified in the MAC. All maintenance procedures required to complete a maintenance function are identified under THIS TASK COVERS: in the order in which the work is most logically accomplished.

PARACHUTE REPACK INTERVAL

The MC1-1C/MC1-1D parachutes will be repacked at a scheduled interval to insure airworthiness. When necessitated by climate/storage/use condition, the local airdrop equipment maintenance officer may require more frequent repack intervals. In this regard, a major concern would be rapid fluctuations of temperature (fluctuations around 32 degrees Fahrenheit, freezing point) sustained high or low temperature, or high humidity and heavily polluted atmosphere. The MC1-1C/MC1-1D troop back parachute assemblies will be repacked at a 120-day interval.

DROP TESTING CRITERIA

Drop-testing of the MC1-1C/MC1-1D troop back parachute assemblies consist of physically airdropping an item from an aircraft in flight. The drop-test is used as a means of proving the serviceability of an item or checking parachute rigger proficiency, and will only be performed under the supervision of qualified parachute rigger personnel who satisfy the supervisory requirements outlined in AR 750-32. Drop-testing will usually be conducted by an activity responsible for the inspection and maintenance of airdrop equipment, which includes either parachute packing or airdrop load rigging. The criteria required to accomplish a drop test is as follows:

1. To drop-test a troop-type personnel parachute, a qualified parachute rigger will jump the parachute and the applicable type parachute will be released under conditions that are consistent with the requirements for a personnel jump or equipment drop.
2. During the drop-test of any type parachute, the deployment of the parachute will be thoroughly monitored and observed to detect any indication of malfunction or defect. A subsequent record of the applicable parachute log record will be entered into the applicable log record using procedures outline in WP 0003 00.
3. Any type of airdrop equipment that indicates evidence of malfunction/defect during, or after, a drop-test will be disposed of as prescribed in WP 0009 00.
4. A personnel parachute that is considered to have contributed to the injury of an individual parachutist (critical or fatal) will be disposed of in accordance with WP 0009 00, Equipment Disposition.
5. Airdrop equipment that does not reflect evidence of malfunction or defect upon completion of a drop-test will be administered a technical/rigger-type inspection as outlined in WP 0009 00. If serviceable, the item(s) may then remain in use.

END OF WORK PACKAGE

THIS PAGE INTENTIONALLY LEFT BLANK

**MC1-1C/MC1-1D TROOP BACK PARACHUTE ASSEMBLY
PREVENTIVE MAINTENANCE CHECKS AND SERVICES (PMCS)**

GENERAL

The following describe PMCS procedures on the unit and direct support levels. The PMCS table has been provided to ensure the MC1-1C/MC1-1D parachute is in proper operating condition, and ready for its primary mission.

Frequency of Performing PMCS. PMCS will be performed before equipment is packed for use, during modification and repair after use, or at any time deemed necessary by the air delivery equipment maintenance officer.

PMCS Columnar Entries Table 1.

Item Number. The item number column shall be used as a source of the item number required for the TM Number column on DA Form 2404 (Equipment Inspection and Maintenance Worksheet), when recording the results of the PMCS.

Interval. This column identifies the required PMCS interval.

Item to be Inspected. Contains the common name of the item to be inspected.

Procedures. Provides a brief description of the procedures by which the checks are to be performed.

Recording Defects. All defects discovered during the inspection will be recorded using the applicable specifics in DA Pamphlet 738-750, DA Pamphlet 738-751 and TB 43-0002-43.

Over Age Items. During any inspection, or at any time that an item is found to be over age (i.e., shelf/service-life has expired as specified in TB 43-0002-43), the item will be removed from service, condemned, and tagged, in accordance with DA PAM 738-751.

Conservation of Resources. To conserve time and labor, and to avoid evacuation to a direct support maintenance activity, unit/detachment commanders may designate, in writing, rigger personnel to accomplish classification inspection of over age air delivery equipment and the classification of Beyond Economical Repair (BER) parachutes.

Inspection Function Requirement. Normally, air delivery equipment maintenance personnel at a packing, rigging, or repair activity will perform a technical/rigger-type inspection. The inspection of initial receipt items will be performed as a separate function from packing or rigging activity; the item to be inspected will be placed in proper layout on a packing table or suitable sized floor area.

Should defect or damage be discovered at any point during the inspection, the inspection will be terminated and the applicable item will be processed and forwarded to repair activity. The repair activity, in turn, will conduct a technical/rigger-type inspection that will be performed by only those parachute rigger personnel cited in AR 750-32. The repair activity inspection of personnel parachutes will be made on the shadow table.

Any defect discovered during a unit level repair activity inspection, that exceeds the capability of that activity, will require the affected item to be evacuated to a direct support maintenance function.

NOTE

Parachutes that are deemed unserviceable, by a packing or rigging activity, will be rigger-rolled (see the ACCORDION FOLDING/RIGGER ROLLING paragraph detailed in WP 0040 00) prior to being sent to a repair activity.

Table 1. Preventive Maintenance Checks and Services (PMCS).

B – Before

D – During

A - After

| ITEM NO. | INTERVAL | | | ITEM TO BE INSPECTED | PROCEDURES |
|----------|----------|---|---|------------------------|--|
| | B | D | A | | |
| 00 | * | | * | MC1-1C/MC1-1D Assembly | Verify that assembly is complete, and no components are missing. Check for proper assembly, foreign material, mildew or stains, and log record book. |
| 01 | * | | * | Canopy | <p><i>Canopy Assembly Fabric.</i> Inspect for rips, burns, holes, tears, dampness, debris, frays, broken or loose stitching, and marred and illegible marks.</p> <p><i>Bridle Loop.</i> Inspect for cuts, breaks, frays, burns, improper installation, and loose or broken stitching.</p> <p><i>Apex Line.</i> Inspect for burns, cuts, thin cords, breaks, and loose or broken stitching on lateral band or radial seam.</p> <p><i>Upper Lateral Band.</i> Inspect the upper lateral band for holes, cuts, frays, tears, burns, and loose or broken stitching.</p> <p><i>Gore Sections.</i> Inspect the gore sections for dampness, dirt, foreign material, holes, cuts, snags, tears, frays, burns, loose or broken stitching, and marred or illegible markings.</p> <p><i>Informational Data Block.</i> Inspect for illegibility of data.</p> <p><i>Radial Seams.</i> Inspect for loose and broken stitching, holes and tears.</p> <p><i>Radial Tapes.</i> Inspect for loose or broken stitching, holes, tears, and lack of freedom within radial seam.</p> <p><i>V-Tabs.</i> Inspect for loose or broken stitching, frays, tears, burns, and cuts.</p> |

Table 1. Preventive Maintenance Checks and Services (PMCS) - Continued

B – Before

D – During

A - After

| ITEM NO. | INTERVAL | | | ITEM TO BE INSPECTED | PROCEDURES |
|----------|----------|---|---|----------------------|--|
| | B | D | A | | |
| 01 | * | | * | Canopy - Continued | <p><i>Pocket Bands.</i> Inspect for cuts, frays, tears, burns, and loose or broken stitching.</p> <p><i>Lower Lateral Bands.</i> Inspect for loose or broken stitching, rips, snags, and burns.</p> <p><i>Anti-Inversion Net.</i> Check for cuts, broken cords, and loose or broken stitching.</p> <p><i>Lines.</i> Inspect for loose or broken stitching, broken lines, broken core cords, frays, burns, and tears.</p> <p><i>Connector Links.</i> Inspect for rust, burrs, rough spots, corrosion, cracks, foreign material, loose or missing screws, stripped threads, and ends not locked.</p> <p><i>Control Lines.</i> Inspect for loose or broken stitching, broken case cords, frays, burns, tears, or broken lines.</p> <p><i>Control Line Reefing Ring.</i> Inspect for burrs, rust, rough spots, corrosion, cracks and bends.</p> <p><i>Control Line Bridles.</i> Inspect for loose or broken stitching, broken case cords, frays, burns, tears, and broken lines.</p> <p><i>Toggle.</i> Inspect for rough spots and cracks.</p> <p><i>Control Line Guide Ring.</i> Inspect for rust, burrs, rough spots, corrosion, cracks, and bends.</p> <p><i>Guide Ring Retaining Strap.</i> Inspect for loose or broken stitching, frays, tears, and cuts.</p> |
| 02 | * | | * | Risers | <p><i>Risers.</i> Inspect for loose or broken stitching and tacking, burns, frays, tears, deterioration, and marred (or illegible) markings.</p> <p><i>Canopy Release Male Fittings.</i> Inspect for corrosion, rough spots, bends, and cracks.</p> |

Table 1. Preventive Maintenance Checks and Services (PMCS) - Continued

B – Before

D – During

A - After

| ITEM NO. | INTERVAL | | | ITEM TO BE INSPECTED | PROCEDURES |
|----------|----------|---|---|----------------------|--|
| | B | D | A | | |
| 02 | * | | * | Risers - Continued | <p><i>Log Record Pocket.</i> Inspect for loose or broken stitching</p> <p>Identification Tape. Inspect for loose or missing blue pressure sensitive adhesive tape.</p> |
| 03 | * | | * | Harness | <p><i>All Webbings, Bindings, and Cloth Duck.</i> Inspect for loose or broken stitching, burns, frays, tears, and marred or illegible markings.</p> <p><i>All Hardware & Functional Fittings.</i> Inspect for improper operation, rust, corrosion, burrs, & cracks.</p> <p><i>Retainer Webbings.</i> Inspect for loose or broken stitching, loss of elasticity, cuts and frays.</p> <p><i>Canopy Release and Ejector Snap Pads.</i> Inspect for loose or broken stitching and hand tacking, cuts, and tears.</p> <p><i>Horizontal Back-strap: 96-Inch and 120-Inch.</i> Inspect for loose or broken stitching, burns, frays, tears, and marred (or illegible) markings.</p> |
| 04 | * | | * | Pack Tray | <p><i>Pack Tray.</i> Inspect for illegible markings. Inspect webbings, bindings, and duck cloth for loose or broken stitching and tacking, holes, tears, burns, and frays.</p> <p><i>Back-strap Retainers & Keepers.</i> Inspect for loose or broken stitches, tears, burns or frays, and missing (or damaged) snap fasteners.</p> <p><i>Pack Closing Loop.</i> Inspect for loose or broken stitches, burns, frays and tears.</p> <p><i>Retainer Band Keepers.</i> Inspect for loose or broken stitches, burns, frays and tears.</p> <p><i>Static Line Slack Retainer.</i> Inspect for loose or broken stitches, burns, frays, tears and elasticity.</p> <p><i>Waistband & Waistband Extension.</i> Inspect for loose or broken stitches, burns, frays and tears; and check metal adjuster for rust, burrs or corrosion.</p> |

Table 1. Preventive Maintenance Checks and Services (PMCS) - Continued

B – Before

D – During

A - After

| ITEM NO. | INTERVAL | | | ITEM TO BE INSPECTED | PROCEDURES |
|----------|----------|---|---|--|---|
| | B | D | A | | |
| 05 | * | | * | Deployment Bag | <p><i>Deployment Bag.</i> Inspect all webbing and tapes for loose or broken stitching.</p> <p><i>Main Panel.</i> Inspect for holes and tears, loose and broken stitching.</p> <p><i>Stow Loops and Reinforcement Panel.</i> Inspect for loose or broken stitching, holes, tears, burns or frays.</p> <p><i>Edge Reinforcement Webbing.</i> Inspect for loose and broken stitching, holes, tears, burns or frays.</p> <p><i>Side Flaps.</i> Inspect for loose and broken stitching, holes, tears, burns or frays.</p> <p><i>Locking Stow Panel.</i> Inspect for loose and broken stitching, holes, tears, burns or frays.</p> <p><i>Locking Stow Loop Hoods.</i> Inspect for loose or broken stitching, holes, tears, burns or frays.</p> <p><i>Closing & Locking Stow Loops.</i> Inspect for loose or broken stitching, holes, tears, burns, or frays.</p> <p><i>Suspension Line Protection Cover.</i> Inspect for loose or broken stitching, holes, tears, burns, frays and illegibility of markings.</p> <p><i>Cover Tiedown Loops.</i> Inspect for loose or broken stitching, holes, tears, burns or frays.</p> <p><i>Connector Link Tie Loops.</i> Inspect for loose or broken stitching, holes, tears, burns or frays.</p> |
| 06 | * | | * | Standard Static Line & Static Line Extension | <p><i>Webbing.</i> Inspect for loose or broken stitching, holes, line extension tears, burns or frays.</p> <p><i>Sleeve and Buffer.</i> Inspect for loose or broken stitching, holes, tears, burns or frays. Inspect entire portion of static line covered by sleeve.</p> <p><i>Pack Opening Loop.</i> Inspect for loose or broken stitching, burns, tears or frays.</p> |

Table 1. Preventive Maintenance Checks and Services (PMCS) - Continued

B – Before

D – During

A - After

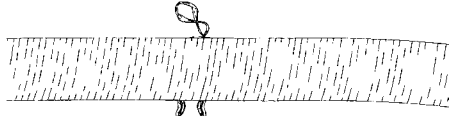
| ITEM NO. | INTERVAL | | | ITEM TO BE INSPECTED | PROCEDURES |
|----------|----------|---|---|--|--|
| | B | D | A | | |
| 06 | * | | * | Standard Static Line & Static Line Extension – Continued | <p><i>Snap Hook.</i> Inspect for proper operation, excessive wear, rust, burrs, corrosion, and cracks. Verify that proper hole has been drilled.</p> <p><i>Safety Pin.</i> Inspect for rust, corrosion, breaks, and twists.</p> <p><i>Safety Pin Lanyard.</i> Inspect for proper ties, frays, thin spots and breaks.</p> |
| 07 | * | | * | Universal Static Line (USL) | <p><i>Webbing.</i> Inspect for loose or broken stitching, holes, line extension tears, burns or frays.</p> <p>Static line webbing with minor abrasions are serviceable. Minor Abrasions are visible on the surface of the USL webbing and will appear to look “fuzzy”.</p>  <p style="text-align: center;">Minor Abrasion.</p> <p>Static line webbing with major abrasions are unserviceable. Major abrasions are visible when inner core fibers are pulled through the surface of the webbing.</p>  <p style="text-align: center;">Major Abrasion.</p> <p><i>Sleeve and Buffer.</i> Inspect for loose or broken stitching, holes, tears, burns or frays. Inspect entire portion of static line covered by sleeve.</p> <p><i>Pack Opening Loop.</i> Inspect for loose or broken stitching, burns, tears or frays.</p> <p><i>Snap Hook.</i> Inspect for proper operation, excessive wear, rust, burrs, corrosion, and cracks.</p> |

LUBRICATION SERVICE INTERVALS

MC1-1C/MC1-1D Troop Back Parachute Assemblies do not require lubrication service.

END OF WORK PACKAGE

CHAPTER 3

UNIT MAINTENANCE INSTRUCTIONS FOR MC1-1C TROOP BACK PARACHUTE ASSEMBLY MC1-1D TROOP BACK PARACHUTE ASSEMBLY

THIS PAGE INTENTIONALLY LEFT BLANK

UNIT MAINTENANCE
MC1-1C/MC1-1D TROOP BACK PARACHUTE ASSEMBLY
SHAKEOUT AND AIRING

THIS TASK COVERS:

- Shakeout
 - Airing
-

INITIAL SETUP:**Materials/Parts**

Brush, Scrub, Household (Item 3, WP 0055 00)

References

WP 0040 00

Personnel Required

Two, 92R(10) Parachute Rigger

Equipment Condition

Parachute Suspended.

SHAKEOUT

A two-person team, either indoors within a shakeout room or outdoors at a shakeout tower, will accomplish the shakeout. Each parachute will be suspended by the canopy bridle loop and all debris removed by shaking the canopy thoroughly or by brushing with a dry, soft-bristled brush, as detailed below:

1. With assistance from the No. 2 person, the No. 1 person will connect the snap on a pulley rope to the canopy bridle loop.

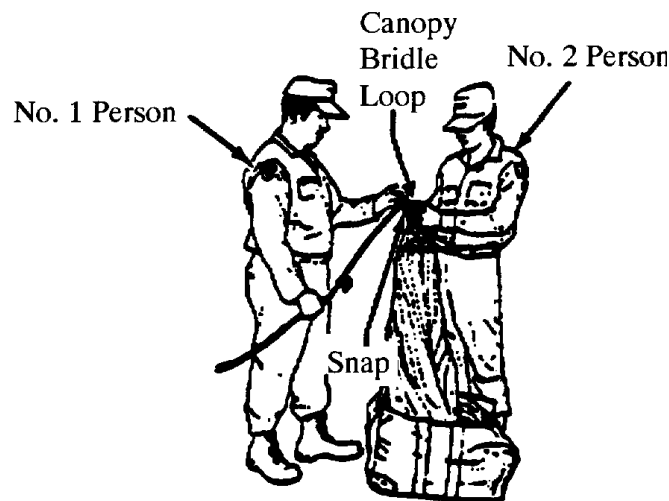

2. Through use of the pulley rope, the No. 2 person will raise the canopy to a suitable height; this will enable the No. 1 person to perform shakeout on each of the canopy gores. Until the gore shaking process is completed, the No. 2 person will maintain a steady pull on the pulley rope to hold the suspended canopy at the working height needed by the No. 1 person.

3. The No. 1 person will grasp any two-consecutive suspension lines, one in each hand, and vigorously shake the first gore.

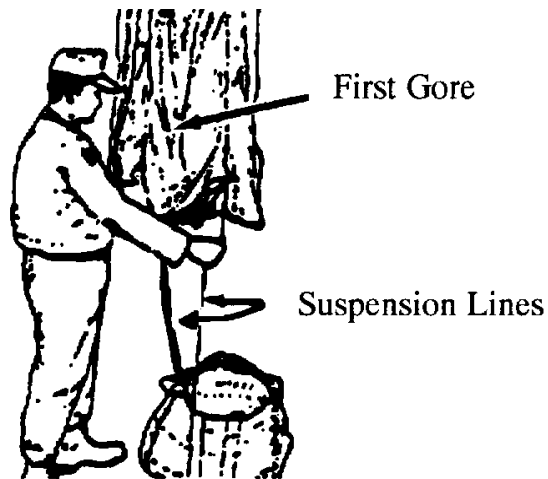

4. When the gore is free of debris, the No. 1 person passes the line from the right hand to the left hand and grasps the next consecutive suspension line, in the right hand. The No. 1 person will shake out each consecutive gore until all suspension lines are held in the left hand, and all gores are free of debris.
5. Once the gore shaking process is completed, the No. 2 person will slowly raise the suspended canopy higher as the No. 1 person clears the suspension lines of debris and removes entanglements, when possible.

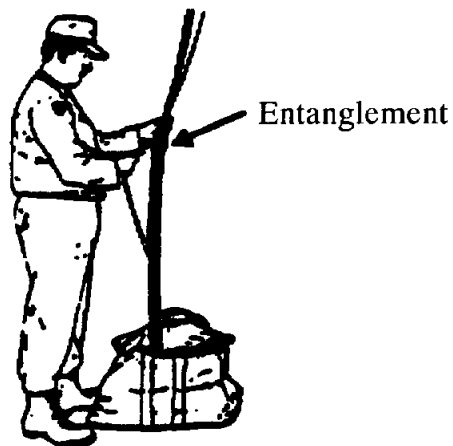

6. After the suspension lines have been cleared, the No. 2 person may hold, or temporarily secure, the pulley rope while the No. 1 person proceeds to clear debris from other parachute components such as the risers, harness, and pack tray.

7. When all components are free of debris, the No. 2 person will slowly lower the canopy, while the No. 1 person S-folds the suspension lines into the pack tray, or aviator's kit bag, as applicable.

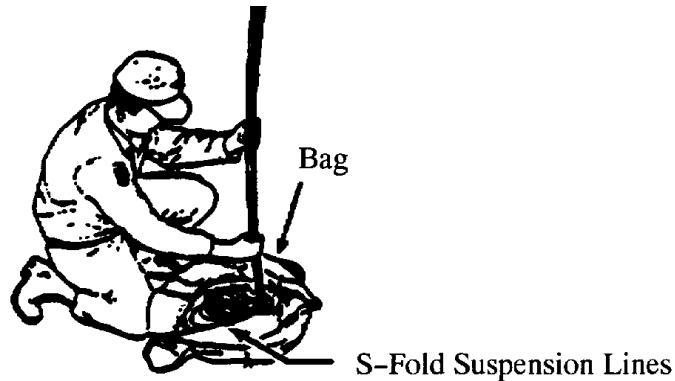

8. After the suspension lines have been completely folded, the No. 1 person will accordion-fold the canopy length on top of the folded lines (see WP 0040 00).
9. As the canopy folding is being completed, the No. 1 person disconnects the canopy vent from the pulley rope snap. Secure the folded canopy assembly for further handling.

AIRING

Where dampness and mildew are prevalent, air delivery equipment will be aired at frequent intervals according to the severity of the prevailing conditions. Parachutes that have been previously packed or are unpacked, and have been subjected to conditions of dampness or mildew, will be aired for a period of at least 6-hours prior to being repacked. Air delivery items may be aired either indoors or outdoors, in dry weather. However, fabric items will not be aired in direct sunlight. Airing may be accomplished by suspending or elevating the applicable item(s) in a manner that would allow maximum exposure to air circulation. Outside facilities used for the shakeout of parachutes may be used for the airing of air delivery equipment, if weather conditions permit. If the shakeout facilities are inadequate for airing, the applicable item(s) may be suspended or elevate at several points, or draped over suitable type objects that will not cause damage.

END OF WORK PACKAGE

THIS PAGE INTENTIONALLY LEFT BLANK

UNIT MAINTENANCE
MC1-1C/MC1-1D TROOP BACK PARACHUTE ASSEMBLY
CLEANING AND DRYING

THIS TASK COVERS:

- Cleaning fabric items with dishwashing compound
 - Rinsing parachute assembly immersed in salt water
 - Rinsing parachute assembly immersed in fresh water
 - Drying fabric items
 - Cleaning metal items
-

INITIAL SETUP:**Materials/Parts**

Cloth, Abrasive (Item 6, WP 0055 00)
Dishwashing Compound (Item 16, WP 0055 00)
Lubricant, Solid Film (Item 24, WP 0055 00)
Rag, Wiping (Item 31, WP 0055 00)
Brush, Scrub Household (Item 3, WP 0055 00)

Personnel Required

92R(10) Parachute Rigger

Equipment Condition

Laid out on packing table or other suitable surface.

CAUTION

If, during the cleaning, there exists a possibility that the substance to be removed contains acid or some other equally destructive ingredient, the item will be evacuated to intermediate maintenance activity for determination as to the nature of the substance and item disposition. If the substance cannot be identified, or if normal repair procedures will not eliminate all traces of chemical or acid damage, the applicable item will be condemned.

NOTE

Cleaning of parachutes should be held to a minimum and should be performed only when necessary, to prevent malfunction or deterioration. When a parachute contains debris, or when it is soiled by dirt, oil, grease, rust, corrosion, or other foreign substances, to such an extent that cleaning is necessary, the cleaning should be performed manually and should be limited to the soiled area only, unless the parachute has been contaminated by water. The methods of cleaning must be determined by the nature of the substance to be removed. Do not use cleaning solvent to clean items soiled by airsickness. Use a solution of hand dishwashing compound to clean this type of soiling.

CLEANING FABRIC ITEMS WITH A SOLUTION OF HAND DISHWASHING COMPOUND

Use dishwashing compound to clean fabric items as follows:

1. Gently brush with a soft bristle brush.
2. Spot clean with a solution of dishwashing compound.
 - a. Dissolve one-half cup of dishwashing compound in one-gallon of warm water.
 - b. Rub the soiled area with a clean cloth dampened with a solution of dishwashing compound.
 - c. Rinse the cleaned area by repeating the rubbing process, with a clean portion of the cloth dampened with water.

RINSING PARACHUTE ASSEMBLY IMMERSSED IN SALT-WATER

If the parachute, or any of its components, has been immersed in salt water in excess of 24-hours it will be condemned. Additionally, if the parachute, or any of its components, has been immersed in salt water for a period less than 24-hours, but cannot be rinsed within 48-hours after recovery, it will also be condemned, unless the following actions are performed. Upon removal from the salt water, the parachute is placed in a single heavy duty plastic trash bag, the top of the bag secured closed and kept in a wet state until a rinse can be performed following normal rinse procedures. The bag must be doubled when outside temperatures exceed 85 degrees F. The bags must be inspected after transport and storage to insure the bag did not get torn and the assembly was allowed to dry. Parachutes recovered using this method must be rinsed NLT than 7 days after the salt water immersion or be condemned. However, if the cited time limitations can be met, then immediately upon recover, suspend or elevate the parachute assembly in a shaded area and allow it to drain for at least 5-minutes. Do not attempt to wring the fabric or the suspension lines. Within 48-hours after recover, under the supervision of a qualified parachute rigger (92R), rinse the recovered parachute assembly as follows:

1. Place the parachute assembly in a large watertight container filled with a suitable amount of fresh, clean water to cover the assembly.

NOTE

If the salt-water-soaked parachute assembly is too large to be placed into a rinsing container, then the rinsing process will be affected by applying fresh, clean water to the assembly using a hose.

2. Agitate the container contents by hand for 5-minutes.
3. Remove the parachute assembly from the container and suspend or elevate it in a shaded area, allowing a 5-minute drainage period. Do not attempt to wring the fabric or the suspension lines.
4. Repeat the procedures in steps 1. through 3. above, twice, using fresh, clean water for each rinse.
5. After the third rinse, allow the parachute assembly to drain thoroughly. Upon completion of draining, dry the assembly in accordance with the DRYING FABRIC ITEMS procedures, below.
6. When dried, perform a technical/rigger-type inspection of the parachute assembly. Corroded metal components, or corrosion-stained fabrics or suspension lines, will be either repaired or replaced as prescribed by the Maintenance Allocation Chart (MAC) in WP 0042 00.
7. Record any repair, immersion, and rinsing in the parachute log record as shown in WP 0003 00.

RINSING PARACHUTE ASSEMBLY IMMERSSED IN FRESH-WATER

Any parachute, or its components, that has been immersed in a fresh water lake, river, or stream will not require rinsing unless it has been ascertained that the water is dirty, oily, or otherwise contaminated.

Procedures for handling a fresh water immersed parachute are as follows:

1. *Contaminated fresh water.* If the parachute, or its components, has been immersed in contaminated fresh-water, rinse and dry (see Rinsing Parachute Assembly Immersed in Salt Water, above), and, if applicable, repair.
2. *Uncontaminated fresh-water.* If the parachute, or its components, has been immersed in uncontaminated fresh-water, it will be cleaned and dried as outlined in Cleaning Fabric Items with a Solution of Hand Dishwashing Compound, Drying Fabric Items, and Cleaning Metal Items, in the detailed paragraphs above and below. Minor discoloration of fabric items, resulting from immersion in uncontaminated fresh-water, may occur.

NOTE

Fabric items will not be dried in direct sunlight or by laying an item on the ground.

DRYING FABRIC ITEMS

Dry fabric items as follows:

1. Suspend or elevate the item in a well-ventilated room or in a heated drying room.
2. Using electric circulating fans may reduce drying time.
3. When heat is used, the heat temperature shall not exceed 160 degrees Fahrenheit (71 degrees Celsius). The preferred temperature is 140 degrees Fahrenheit (60 degrees Celsius).

CLEANING METAL ITEMS

Clean metal items as follows:

CAUTION

Use care not to damage the adjacent fabric materials.

1. Remove burrs, rough spots, rust, or corrosion from metal items by filing with a metal file, or by buffing and polishing with abrasive cloth.
2. Remove all oils and filings by brushing and cleansing with dishwashing compound. Allow to dry.

NOTE

Shield adjacent fabric material before spraying solid film lubricant.

3. Spray metal items with a solid film lubricant and allow to air dry for 24-hours.

NOTE

A small amount of lubricant will not damage fabric, but may cause discoloration and make fabric appear soiled.

END OF WORK PACKAGE

UNIT MAINTENANCE
MC1-1C/MC1-1D TROOP BACK PARACHUTE ASSEMBLY
INSPECTION

THIS TASK COVERS:

- Routine
 - Pack-In-Process
 - Technical/Rigger-Type
 - In-Storage
 - Equipment Disposition
-

INITIAL SETUP:**Equipment Condition**

Packed.

References

DA PAM 738-751

TB 43-0002-43

DA PAM 738-750

AR 750-1

WP 0010 00

Personnel Required

92R(10) Parachute Rigger

ROUTINE INSPECTION

A routine inspection is a visual check performed to ascertain the serviceability of all visible components of a parachute that is packed or rigged for use. The inspection will be made on all components that can be inspected without opening the parachute pack. Prior to issue, a parachute rigger will administer this inspection. Personnel parachutes issued for an air delivery operation and not deployed will receive a routine inspection prior to being placed into ready-for-issue storage.

PACK-IN-PROCESS INSPECTION

A pack-in-process inspection is performed at specified intervals during the packing of a parachute to ensure that only authorized procedures and methods are being used. A parachute rigger other than the packer or rigger preparing the applicable equipment for use will accomplish the inspection. The intervals, at which the inspection is performed, are as follows:

WARNING

Deployment bag will be given a complete inspection, including static line and that portion of the static line that is covered by the static line sleeve. Failure to do so could result in serious injury or death to the parachutist.

NOTE

For Army personnel, the In-Process-Inspector (IP) qualifications are IAW AR 750-32.

1. After the parachute is placed in proper layout.
2. After the gores are folded and the flatfold is completed.
3. After the canopy is longfolded and the breakcord is tied.
4. After the deployment bag is closed (first regular stow).
5. After the suspension lines are stowed.
6. After the pack tray is closed.
7. After the static line is stowed.

TECHNICAL/RIGGER-TYPE INSPECTION PROCEDURES

Perform inspection as follows:

1. *Overall inspection.* An overall inspection will be made on the MC1-1C/MC1-1D parachute to ascertain the following:
 - a. *Log record/parachute inspection data pocket and form.* As applicable, inspect the assembly log record parachute inspection data pocket to ensure the Army Parachute Log Record (DA Form 3912), NAVWPNCEN or NAVWPNS CL 13512/11(Parachute History Record) is enclosed and properly attached. Further, remove the log record from the pocket and evaluate the recorded entries. Inspect and evaluate as follows:

The Army Parachute Log Record, DA Form 3912, and AFTO 391 are history-type maintenance documents that accompany the parachute canopy and pack tray assemblies through the period of service of the individual assembly. The log record provides a means of recording maintenance actions performed on a parachute canopy assembly. Normally, a log record is initiated and attached to a right rear riser upon receipt by a using unit. However, if the item is subjected to alteration or modification by a maintenance activity during the interim period from date of manufacture to receipt by a using unit, the log record will be prepared by the activity performing the maintenance function. Once initiated, a log record will be attached to, and contained in, an affixed parachute log record/ inspection data pocket, until such time as the parachute canopy assembly is destroyed or rendered unfit for further use or repair. Additionally, should an item that requires a log record, be transferred from one unit to another, the log record for the parachute assembly will accompany the item in the transfer action. A prepared log record will not be removed or separated from a parachute, and especially a packed parachute, except as directed by the local air delivery equipment maintenance activity officer. A log record that is illegible, lost, damaged, soiled, or precludes further entries due to lack of space, will be replaced upon the next repack or inspection, as applicable, with a serviceable item from stock.
 - b. *Assembly completeness.* Ensure the applicable assembly is complete and that no components (or parts) are missing.
 - c. *Operation adequacy.* Check the item components and parts to ensure proper assembly, which includes attachment and alignment, and that the assembled product functions in the prescribed manner. Further, ensure that no stitch formation (or sewn seam) has been omitted.

- d. *Markings and stenciling.* Inspect each assembly and components for faded, illegible, obliterated, or missing informational data and identification numbers.
 - e. *Foreign material and stains.* Inspect each assembly and related components for the presence of dirt or similar type foreign material. Also check for evidence of mildew, moisture, oil, grease, pitch, resin, or contamination by salt water.
2. *Detailed inspection.* In addition to the overall inspection performed in 1., above, a detailed inspection will be performed on the materials that constitute the assembly or component construction using the following criteria, as applicable:
- a. *Metal.* Inspect for rust, corrosion, dents, bends, breaks, burrs, rough spots, sharp edges, wear, deterioration; damaged, loose or missing grommets, safety pins, connector snap, eye hook, pack fastener; improper swaging or welding; loss of spring tension; and missing or loose screws.
 - b. *Cloth.* Inspect for breaks, burns, cuts, frays, holes, rips, snags, tears; loose, missing, or broken stitching or tacking; and weak spots, wear, or deterioration.
 - c. *Fabric tape, webbing, and cordage.* Inspect for breaks, burns, cuts, frays, holes, snags, tears, incorrect weaving, and sharp edges formed from searing; loose, missing, or broken stitching, tacking, whipping, and weaving; weak spots, wear, and deterioration.
 - d. *Pressure-sensitive (adhesive) tape.* Inspect for burns, holes, cuts, tears, weak spots; and looseness and deterioration.
 - e. *Rubber and elastic.* Inspect for burns, cuts, holes, tears, weak spots, loss of elasticity and deterioration.

IN-STORAGE INSPECTION

An in-storage inspection is a physical check conducted on a random sample of air delivery equipment that is located in storage. The purpose of the inspection is to ensure that the equipment is ready for issue, that the item is properly identified and segregated from other types of equipment, that no damage or deterioration of equipment has been incurred, and that all modifications or similar action requirements have been completed. The inspection shall also concern the methods and procedures applied to the storage of air delivery items, the adequacy of storage facilities, efforts of pest and rodent control, and protection against unfavorable climatic conditions. Air delivery equipment that is in storage will be inspected at least semiannually and at more frequent intervals if prescribed by the local parachute maintenance officer. The frequency of inspection may vary according to the type of storage facilities and local climatic conditions. Only parachute rigger personnel designated by the local parachute maintenance officer will conduct in-storage inspections.

EQUIPMENT DISPOSITION

Air delivery equipment may be rendered unserviceable by either normal fair wear or by aging, and will be subsequently be repaired, modified, or condemned, as appropriate. Equipment that is uneconomically repairable (outdated) will be condemned. Disposition of air delivery equipment that is condemned, unserviceable, or for which the serviceability is questionable, will be accomplished using the following procedures, as applicable:

1. *Item requiring repair or modification.* An air delivery item that requires repair or modification will be tagged in accordance with DA PAM 738-751. Subsequent work on the item will be performed at the maintenance level specified for the maintenance function in the applicable supporting technical publication.

2. *Parachutes with exhausted age or service life.* Any parachute component or air delivery equipment whose age or service life has expired as specified in TB 43-0002-43 will be removed from service, condemned and tagged as prescribed by DA PAM 738-751.
3. *Disposition of condemned air deliver equipment.* Condemned equipment, other than fatality parachutes, will be removed from service and disposed of in accordance with current directives listed in this WP.
4. *Rejected equipment.* Equipment which, prior to use, is deemed unserviceable for use will be reported in an EIR in accordance with DA PAM 738-750, as authorized by AR 750-1. Each applicable item that is defective will be held and safeguarded pending receipt of disposition instructions from the National Maintenance Point (NMP). In all instances, EIR exhibit material will be handled as prescribed in DA PAM 738-750. If the quality or the serviceability of an item is questionable, clarification and assistance may be obtained by contacting Commander, U.S Army Soldier and Biological Chemical Command, ATTN: AMSSB-RIM-E(N), Kansas Street, Natick, MA 01760-5052.
5. *Equipment of doubtful serviceability.* Equipment that has had previous use and has not exceeded normal fair wear or aging criteria, but of which further serviceability is doubtful, will be tagged as prescribed in DA PAM 750-751. In addition, the equipment will be reported in an EIR, in accordance with DA PAM 738-750 and AR 750-1. The item(s) in question will be held as EIR exhibit material as outlined in D PAM 738-750 pending receipt of disposition instructions from the NMP. A maintenance activity holding EIR exhibit material will not tamper with the applicable item(s) or make any attempt to ascertain cause factors. Unnecessary handling of EIR exhibit material may disturb or alter peculiar aspects of the affected item(s) that might affect the judgment of engineering personnel who have the responsibility for final evaluation of EIR actions.
6. *Equipment immersed in salt-water.* Any air delivery item constructed from cotton material that has been immersed in salt-water will be condemned. Cotton thread used for tacking and sewing on nylon parachute packs that have been immersed in salt-water will only be replaced when there is visible evidence or deterioration such as extreme discoloration or indications of broken thread. Any air delivery equipment constructed of nylon or rayon material that has been immersed in salt-water for a period less than 24-hours, but which cannot be rinsed within 48-hours after recovery will also be condemned, unless the following actions are performed. Upon removal from the salt water, the parachute is placed in a single heavy duty plastic trash bag, the top of the bag secured closed and kept in a wet state until a rinse can be performed following normal rinse procedures. The bag must be doubled when outside temperatures exceed 85 degrees F. The bags must be inspected after transport and storage to insure the bag did not get torn and the assembly was allowed to dry. Parachutes recovered using this method must be rinsed NLT than 7 days after the salt water immersion or be condemned. However, if the cited time limitations can be met, then immediately upon recovery, suspend or elevate the recovered equipment in a shaded area and allow the item(s) to drain for at least 5-minutes. Do not attempt to wring the equipment fabric or the suspension lines. Within 48-hours after recovery, under the supervision of a qualified parachute rigger (92R), rinse the recovered equipment as indicated in WP 0010 00.

END OF WORK PACKAGE

UNIT MAINTENANCE
MC1-1C/MC1-1D TROOP BACK PARACHUTE ASSEMBLY
SALT/FRESH-WATER CONTAMINATION TEST

THIS TASK COVERS:

- Inspection
-

INITIAL SETUP:

Equipment Condition

Laid out on packing table or other suitable area.

Personnel Required

92R(10) Parachute Rigger

INSPECTION

Look for a white crystalline residue. If evidence of salt-water/fresh-water contamination is found, refer to the procedures detailed below:

Rinsing Parachute Assembly Immersed in Salt-Water. If the parachute, or any of its components, has been immersed in salt water in excess of 24-hours it will be condemned. Additionally, if the parachute, or any of its components, has been immersed in salt water for a period less than 24-hours, but cannot be rinsed within 48-hours after recovery, it will also be condemned, unless the following actions are performed. Upon removal from the salt water, the parachute is placed in a single heavy duty plastic trash bag, the top of the bag secured closed and kept in a wet state until a rinse can be performed following normal rinse procedures. The bag must be doubled when outside temperatures exceed 85 degrees F. The bags must be inspected after transport and storage to insure the bag did not get torn and the assembly was allowed to dry. Parachutes recovered using this method must be rinsed NLT than 7 days after the salt water immersion or be condemned. However, if the cited time limitations can be met, then immediately upon recover, suspend or elevate the parachute assembly in a shaded area and allow it to drain for at least 5-minutes. Do not attempt to wring the fabric or the suspension lines. Within 48-hours after recover, under the supervision of a qualified parachute rigger (92R), rinse the recovered parachute assembly as follows:

1. Place the parachute assembly in a large watertight container filled with a suitable amount of fresh, clean water to cover the assembly.

NOTE

If the salt-water-soaked parachute assembly is too large to be placed into a rinsing container, then the rinsing process will be affected by applying fresh, clean water to the assembly using a hose.

2. Agitate the container contents by hand for 5-minutes.
3. Remove the parachute assembly from the container and suspend or elevate it in a shaded area, allowing a 5-minute drainage period. Do not attempt to wring the fabric or the suspension lines.
4. Repeat the procedures in steps 1. through 3., above, twice, using fresh, clean water for each rinse.
5. After the third rinse, allow the parachute assembly to drain thoroughly. Upon completion of draining, dry the assembly in accordance with the Drying Fabric Items procedures detailed below.

6. When dried, perform a technical/rigger-type inspection of the parachute assembly. Corroded metal components, or corrosion-stained fabrics or suspension lines, will be either repaired or replaced as prescribed by the Maintenance Allocation Chart (MAC) in WP 0042 00.
7. Record any repair, immersion, and rinsing in the parachute log record as shown in WP 0003 00.

Rinsing Parachute Assembly Immersed in Fresh-Water. Any parachute, or its components, that has been immersed in a fresh water lake, river, or stream will not require rinsing unless it has been ascertained that the water is dirty, oily, or otherwise contaminated. Procedures for handling a fresh water immersed parachute are as follows:

1. *Contaminated fresh water.* If the parachute, or its components, has been immersed in contaminated fresh water, rinse and dry (see Rinsing Parachute Assembly Immersed in Salt Water, above), and, if applicable, repair.
2. *Uncontaminated fresh water.* If the parachute, or its components, has been immersed in uncontaminated fresh water, it will be cleaned and dried as outlined in Cleaning Fabric Items With a Solution of Hand Dishwashing Compound, Drying Fabric Items, and Cleaning Metal Items, in the detailed paragraphs above and below. Minor discoloration of fabric items, resulting from immersion in uncontaminated fresh water, may occur.

NOTE

Fabric items will not be dried in direct sunlight or by laying an item on the ground.

Drying Fabric Items. Dry fabric items as follows:

1. Suspend or elevate the item in a well-ventilated room or in a heated drying room.
2. Using electric circulating fans may reduce drying time.
3. When heat is used, the heat temperature shall not exceed 160 degrees Fahrenheit (71 degrees Celsius). The preferred temperature is 140 degrees Fahrenheit (60 degrees Celsius).

END OF WORK PACKAGE

UNIT MAINTENANCE
MC1-1C/MC1-1D TROOP BACK PARACHUTE ASSEMBLY
PACKING PROCEDURES

THIS TASK COVERS:

- Inspection
- Orientation
- Preparing Parachute for Proper Layout
- Removing Tangles and Twists from Apex Lines
- Removing Inversion
- Removing Turns, Tangles/Twists From Suspension Lines
- Folding the Gores
- Longfolding the Canopy
- Tying Static Line to Bridle Loop of Canopy
- Stowing the Canopy
- Closing Deployment Bag and Stowing Suspension Lines
- Tying Connector Links and Suspension Line Protective Cover
- Closing the Pack Tray
- Stowing the Static Line
- Army Parachute Log Record
- Static Line Extensions
- Folding the Harness

INITIAL SETUP:**Tools**

Packing Weights (Item 21, WP 0042 00)
 Line Separator (Item 16, WP 0042 00)
 Packing Paddle (Item 20, WP 0042 00)
 Knife (Item 13, WP 0042 00)
 Stow Hooks (Item 29, WP 0042 00)
 Plate, Tension (Item 22, WP 0042 00)

Materials/Parts

Retainer Band, Rubber (Item 1, WP 0055 00)
 Webbing, Cotton, Type I, ¼-in. (Item 57, WP 0055 00)
 Tape, Masking, 2-in. (Item 40, WP 0055 00)

Personnel Required

92R(10) Parachute Rigger
 92R(20) Parachute Rigger

Equipment Condition

Parachute cleaned (referenced WP 0008 00)
 and given a shakeout (referenced WP 0007 00).

References

TM 10-1670-201-23
 T.O. 13C-1-41
 NAVAIR 13-1-17
 DA PAM-738-751
 TB 43-0002-43

WARNING

Failure to detect areas of damage may result in malfunction of the parachute and injury, or loss of life, to personnel.

NOTE

The parachute shall be repacked every 120 days.

INSPECTION

If defects or damages are discovered during inspection of a parachute, the parachute must be rigger-rolled and processed for maintenance, in accordance with WP 0040 00. A technical/rigger-type inspection and a pack-in-process inspection must be performed in conjunction with the packing of each parachute (refer to WP 0009 00).

NOTE

Once the USL and USL extension has been used in a parachute deployment from an aircraft, the webbing while under tension will stretch, therefore never returning to its original manufactured dimension. That original manufactured dimension is what determines the static line length serviceability at the in-service inspection.

NOTE

For the USL, when laying out the static line to form the girth hitch, ensure the green ID marking thread of the webbing is on the top.

1. *Attaching USL to the deployment bag.*

- a. Position the deployment bag with the stow loops facing up and pass the 6-inch buffer loop of the USL clockwise, halfway through the break cord attaching strap loop.

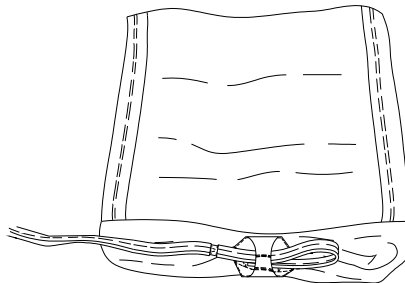

- b. Pass the 3½-inch loop end of the USL through the 6-inch buffer loop, counterclockwise until a taut girth-hitch is formed.

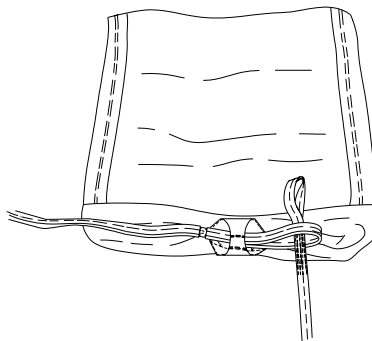

- c. Secure the static line to the deployment bag.

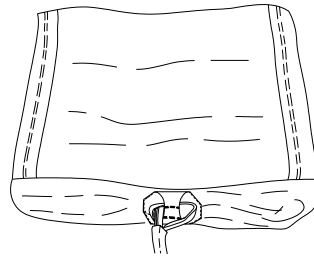

2. *Attaching the snap hook to the USL, or the USL extension.*

- a. Position the snap hook so the opening is facing outward. Lay the static line flat on the packing table; ensure the green ID marking thread is on top and on the outside of the loop.

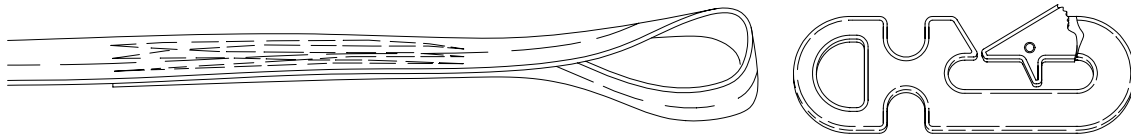

- b. Pass the 3½-inch loop end of the static line through the opening in the base of the snap hook, from bottom to top.

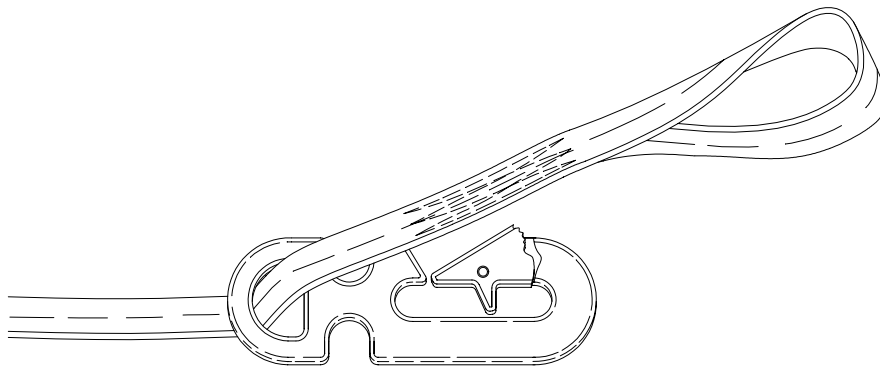

- c. Pass the top of the snap hook through the static line loop.

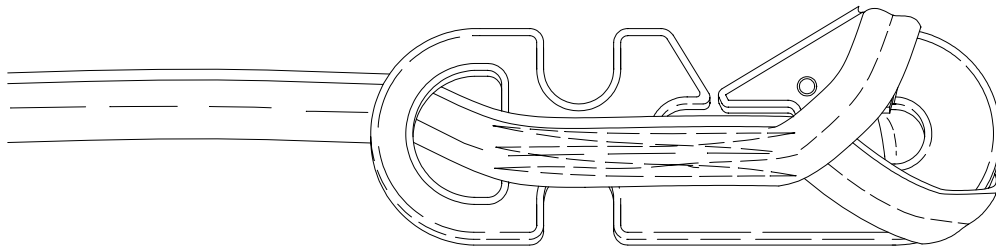

d. Continue passing the snap hook through the static line loop; pull the excess static line back through the opening in the base of the snap hook until the loop is past the snap hook opening.

e. Slide the loop down to the bottom of the snap hook until the static line is fully seated in the indent on the side of the snap hook; form a taut girth-hitch.

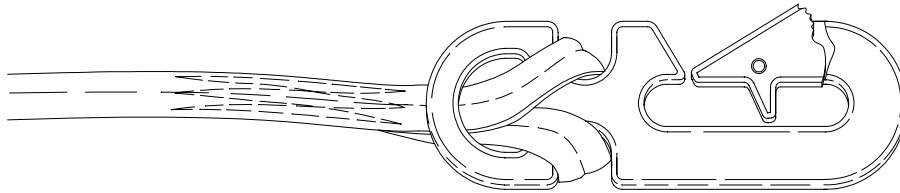

f. Ensure there is no twists in the static line snap hook loop.

NOTE

Before forming the girth-hitch, the green ID marking thread on the USL and USL extension must be on top.

3. *Attaching the USL extension to the USL.*

- a. Attach the USL snap hook to the USL extension as stated in paragraph 2 above.
- b. Pass the 3½-inch loop, on the USL, through the 2-inch buffer loop, on the USL extension.

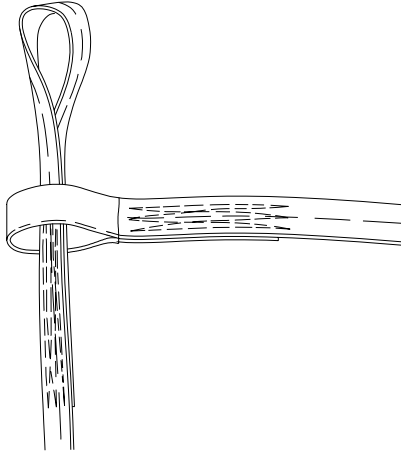

- c. Pass the snap hook, of the USL extension through the 3½-inch loop, on the USL.

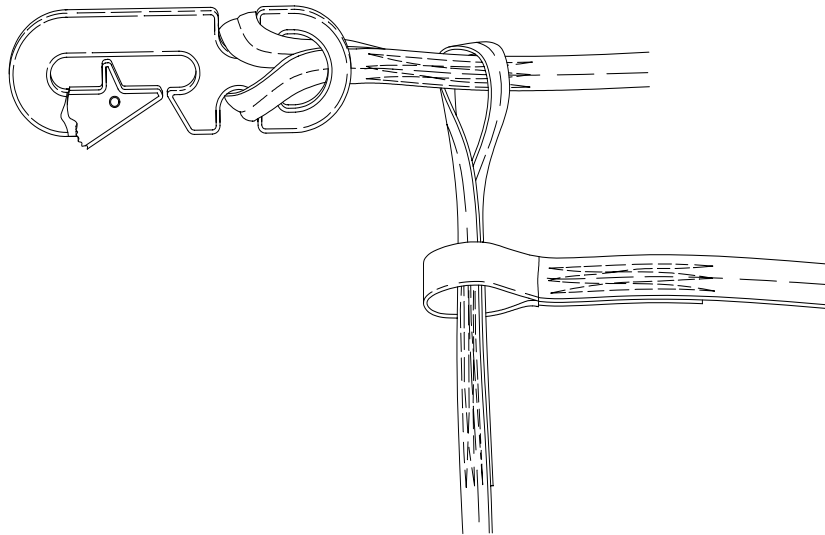

- d. Continue passing the snap hook through the 3½-inch loop until a taut girth-hitch is made securing the USL extension to the USL. (There will be a half-twist in the 3½-inch loop when forming the girth-hitch.)

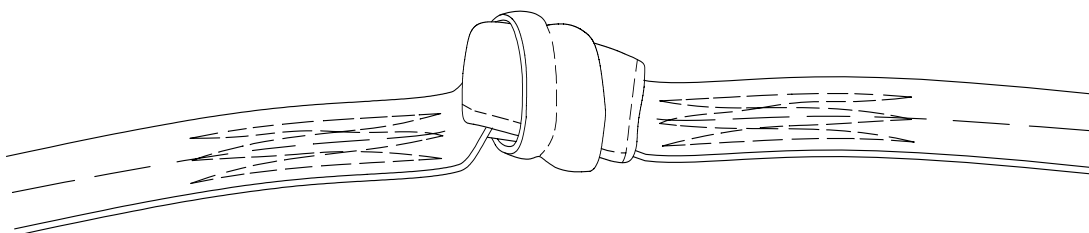

4. *Technical/rigger-type inspection.* Before each parachute is packed by air delivery, it must be given a technical/rigger-type inspection by the packer, in accordance with WP 0009 00.
5. *Pack-in-process inspection.* A designated supervisory rigger, other than the packer, must perform a pack-in-process inspection at seven (7) intervals during the packing procedure. The inspection is performed to ensure that the parachute is packed according to authorized packing procedures (refer to WP 0009 00).

ORIENTATION

Throughout this manual, all directions (right, left, upper, lower, top, bottom, clockwise, and counterclockwise) are given from the rigger's point of view, as the rigger stands at the tension plate end of the packing table, facing the apex-hook end of the table.

1. *Top.* That portion of the equipment that is farthest from the packing table surface.
2. *Bottom.* That portion of the equipment that is nearest to the packing table surface.

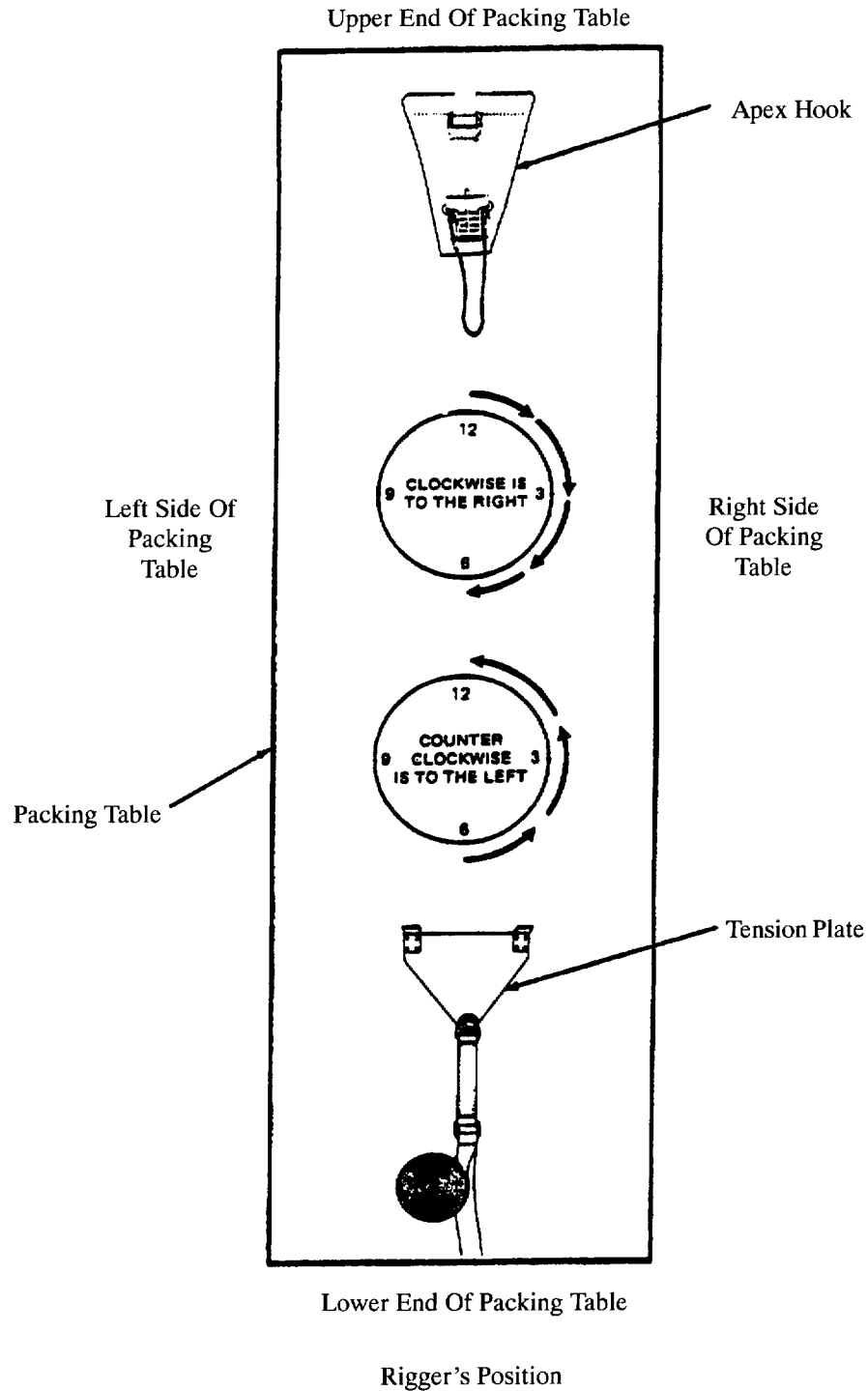

PREPARING THE PARACHUTE FOR PROPER LAYOUT

Prepare the parachute as follows:

1. Place packing tools in convenient locations on the packing table.
2. Lay the canopy assembly lengthwise on the packing table, and attach the canopy to the packing table apex hook.

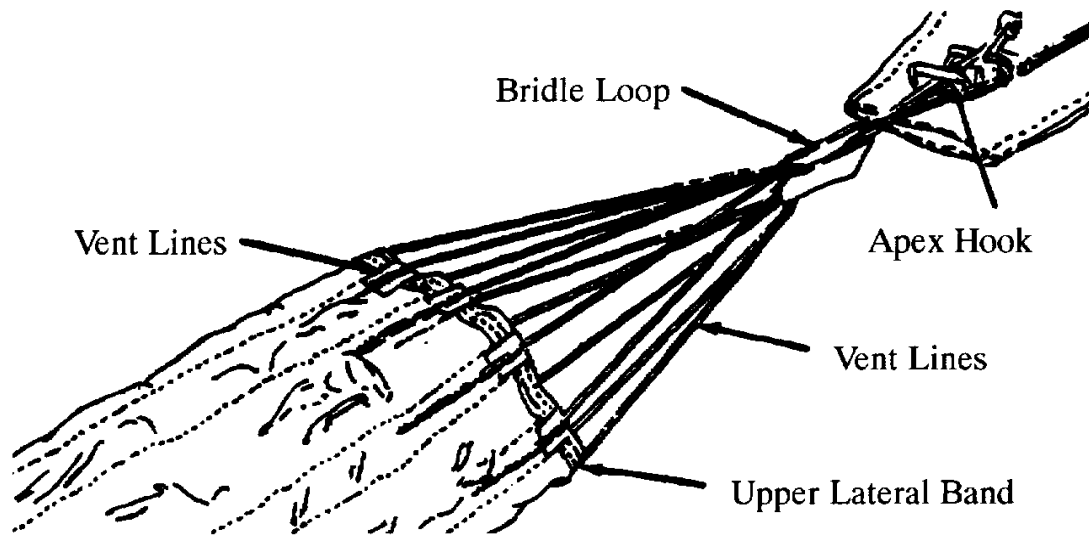

3. Attach the connector links to the tension plate and apply enough tension to keep the canopy on the table.

REMOVING TANGLES/TWISTS FROM APEX LINES

Remove tangles or twists from the apex lines as follows:

1. Locate radial tape 30, at lower lateral band, and follow it to apex line 30, removing turns from the canopy.
2. Continue tracing apex line 30 to the bridle loop; remove any tangles/twists by rotating bridle loop until lines are in proper location.

REMOVING INVERSION

To remove an inversion, proceed as follows (see next page):

1. *Skirt inversion.* Check to see the apex lines are on the outside of the upper lateral.

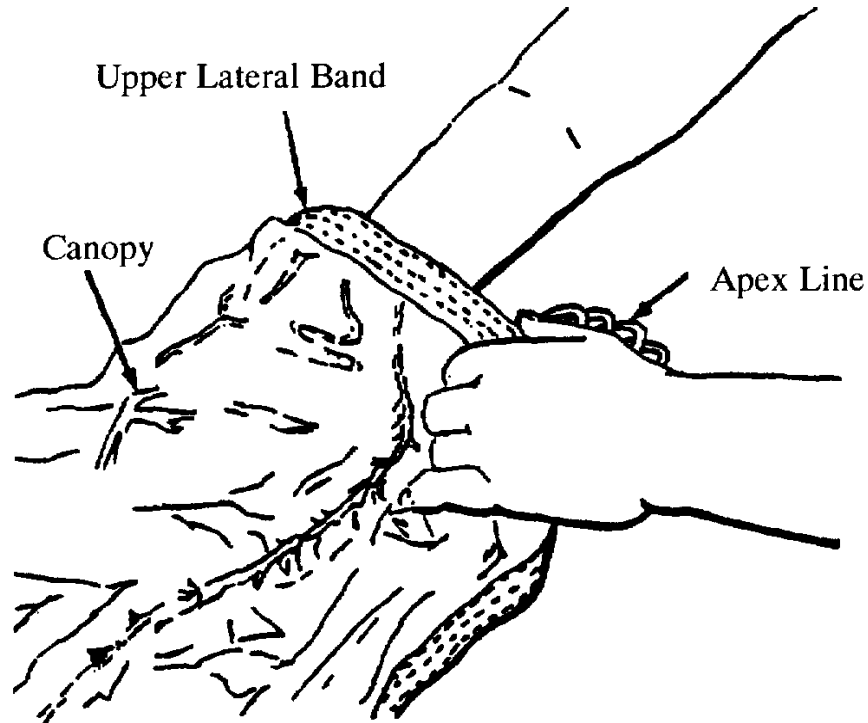

2. If the apex lines are on the inside of the upper lateral band, and the pocket bands are on the inside of the lower lateral band, the canopy is inverted through the skirt. Remove an inversion through the skirt as follows:

NOTE

Be careful not to pass the apex out at the orifice, or around the radial lines at the orifice.

- a. Remove canopy from apex hook.

- b. Pass apex down through the canopy and out the skirt between the two adjacent suspension lines.

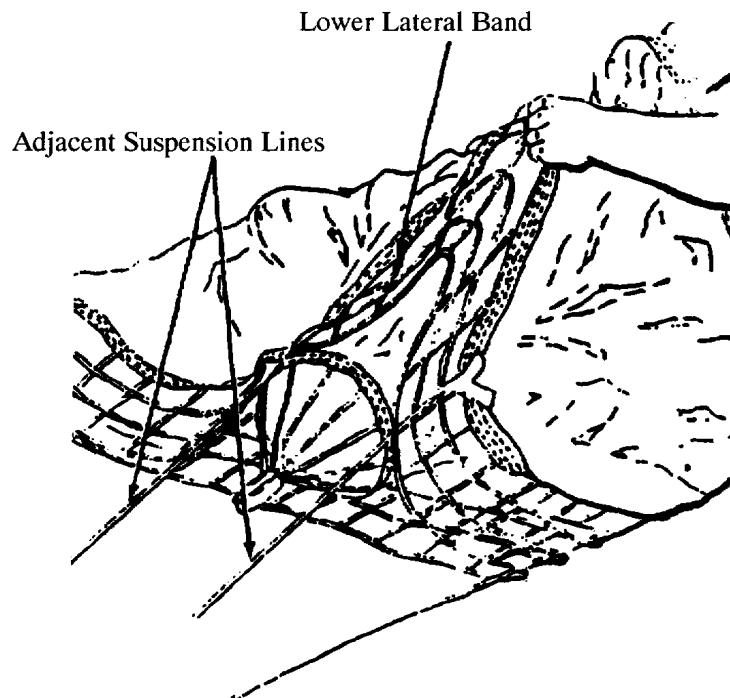

- c. Reattach the canopy to the apex hook.
3. *Orifice inversion.* Two kinds of orifice inversions may be encountered. Remove orifice inversions as follows:
- a. *Apex through the orifice of the canopy.* If the pocket bands appear on the outside and the vent cap appears on the inside, the apex is inverted through the orifice. To remove this kind of orifice inversion, locate the two radial lines through which the canopy has been inverted, and pass the apex lines down through the canopy and out the orifice between these two radial lines.
 - b. *One or two risers through the orifice of the canopy.* For this type of orifice inversion, the upper lateral band is on the inside of the apex lines. If half the V-tabs are on the inside of the lower lateral band, and half are on the outside, the right or left riser is inverted through the orifice. If all the V-tabs are on the outside of the lower lateral band, both risers are inverted through the orifice.

One or both risers may be inverted in one of two directions, either down through the orifice and out of the canopy skirt, or up the canopy skirt and out the orifice. To remove this type of inversion, proceed as follows:

- (1) Place the suspension lines and canopy gores into group separation.
- (2) Determine whether the left or right riser, or both, is inverted and determine the direction of the inversion.
- (3) Remove the connector links from the tension plate and reverse the direction of the riser(s) through the lower portion of the canopy below the orifice.
- (4) Reinstall the connector links on the tension plate.

REMOVING TURNS/ TANGLES/ TWISTS FROM SUSPENSION LINES

To properly locate suspension lines, proceed as follows:

NOTE

Suspension lines 1 thru 30 are divided into two groups, 1 thru 15 are in the left group and 16 thru 30 are in the right group.

1. Locate the top center gore of the canopy and divide the suspension lines into the left and right groups.

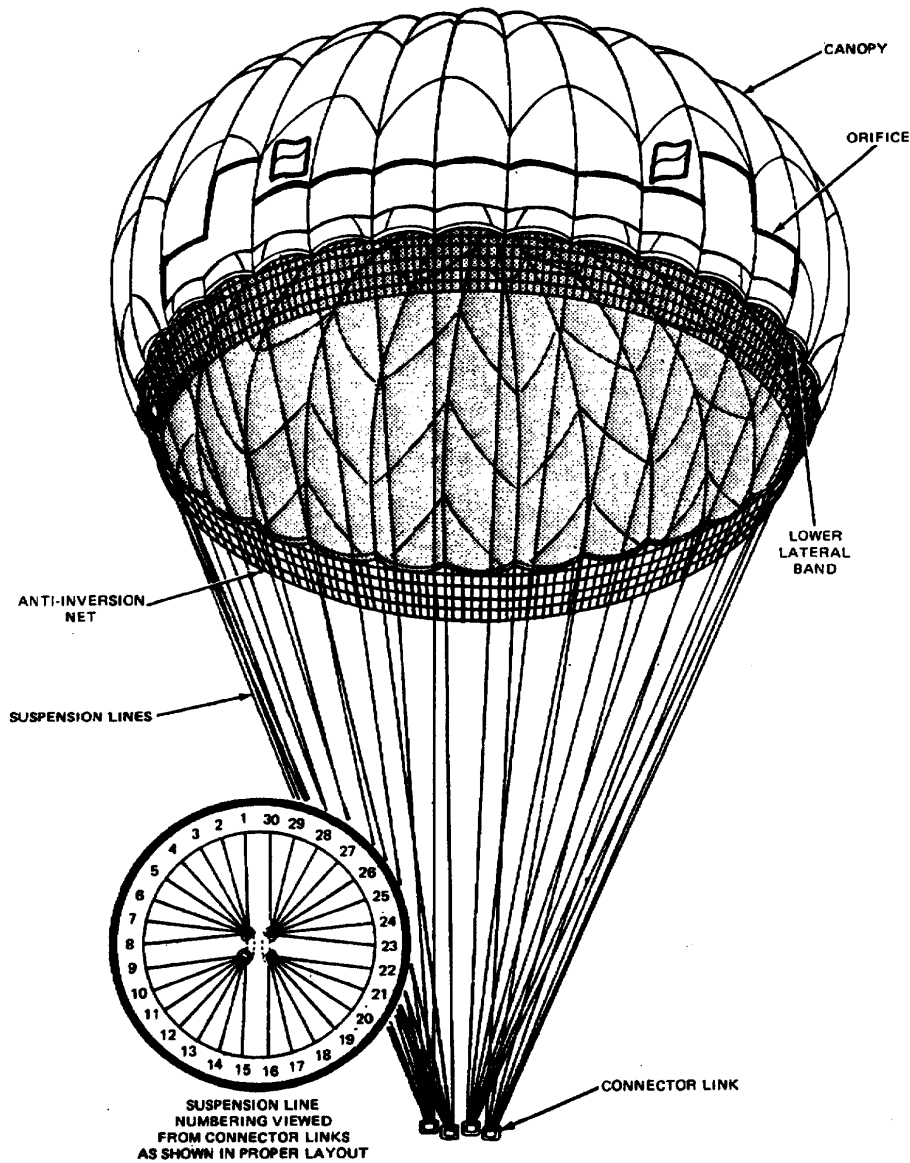

2. Place a packing weight around the right group of lines and the right control line, and move the weight

3. toward the risers; check for turns, tangles and twists.
4. Remove turns, tangles and twists as follows:
 - a. *Turns*. A turn occurs when one group of suspension lines rotates around the other group.

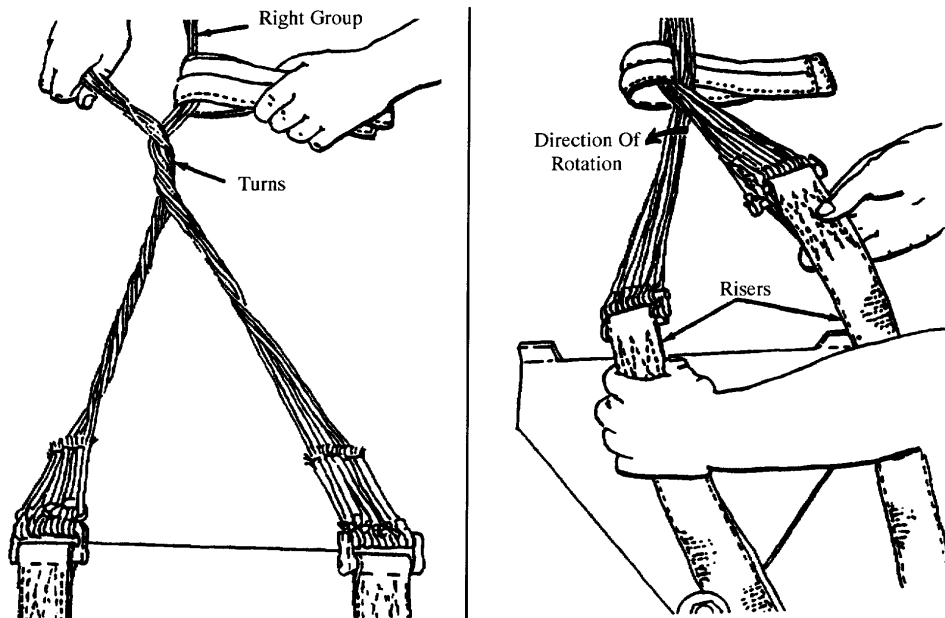

- (1) Remove the connector links from the tension plate and remove a turn by rotating the risers, or pack, in the direction opposite to the direction of the turn.
 - (2) Reposition the connector links on the tension plate.
- b. *Tangles*. To remove tangle(s), keep the two groups of lines separated and work the tangle(s) as close to the connector links as possible. Detach connector links from the tension plate.
- (1) Select the top line(s) that form the tangle and, with the left hand, lift the line(s) away from the other lines.

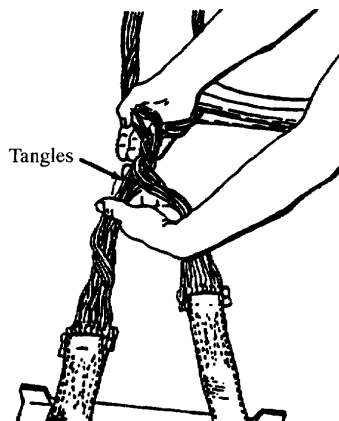

- (2) Reach through the opening, created by lifting the suspension lines, with the right hand.

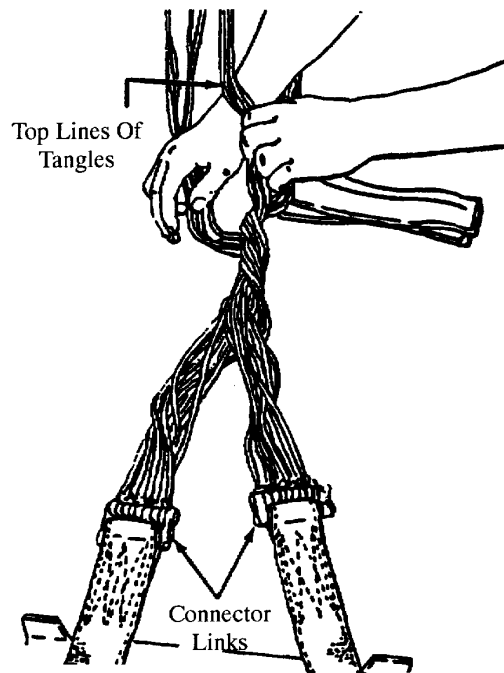

- (3) Pull the risers through the opening. Do not permit risers to turn.

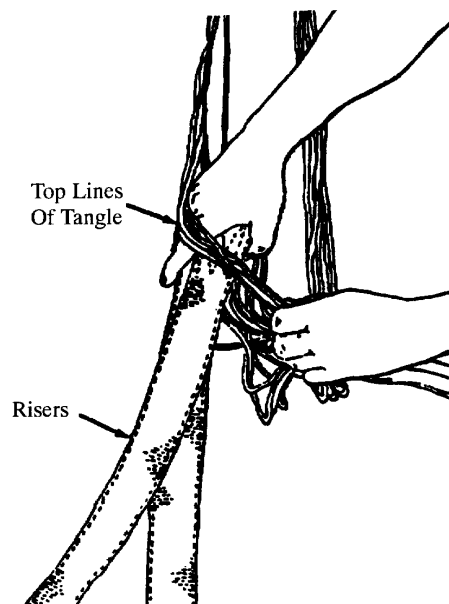

(4) Replace connector links on tension plate.

c. *Twists*. A twist occurs when the suspension lines within one group become improperly crossed.

NOTE

Insert packing weight around lines 1 and 15 while working on lines 16 and 30.

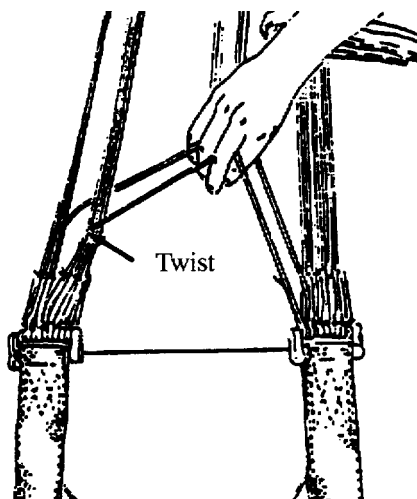

(1) To remove twists, grasp the top and bottom inside lines (lines 1 and 30) at the skirt of canopy and trace them to the connector links.

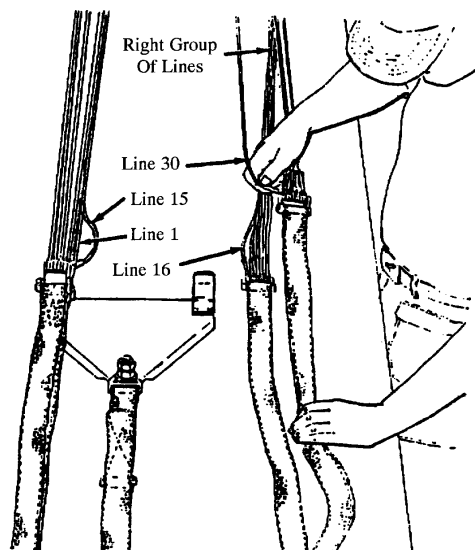

- (2) Remove twists from one group at a time by rotating risers until lines are in proper location on the connector links.
5. Check the suspension lines for proper layout. Left group should have line 1 on the top inside of the connector link and line No. 15 on the bottom inside of the connector link. The right group will have line No. 30 on the top inside of the connector link and line No. 16 on the bottom inside of the connector link. Ensure the control lines are routed to the inside of the risers and are not routed around any of the suspension lines.

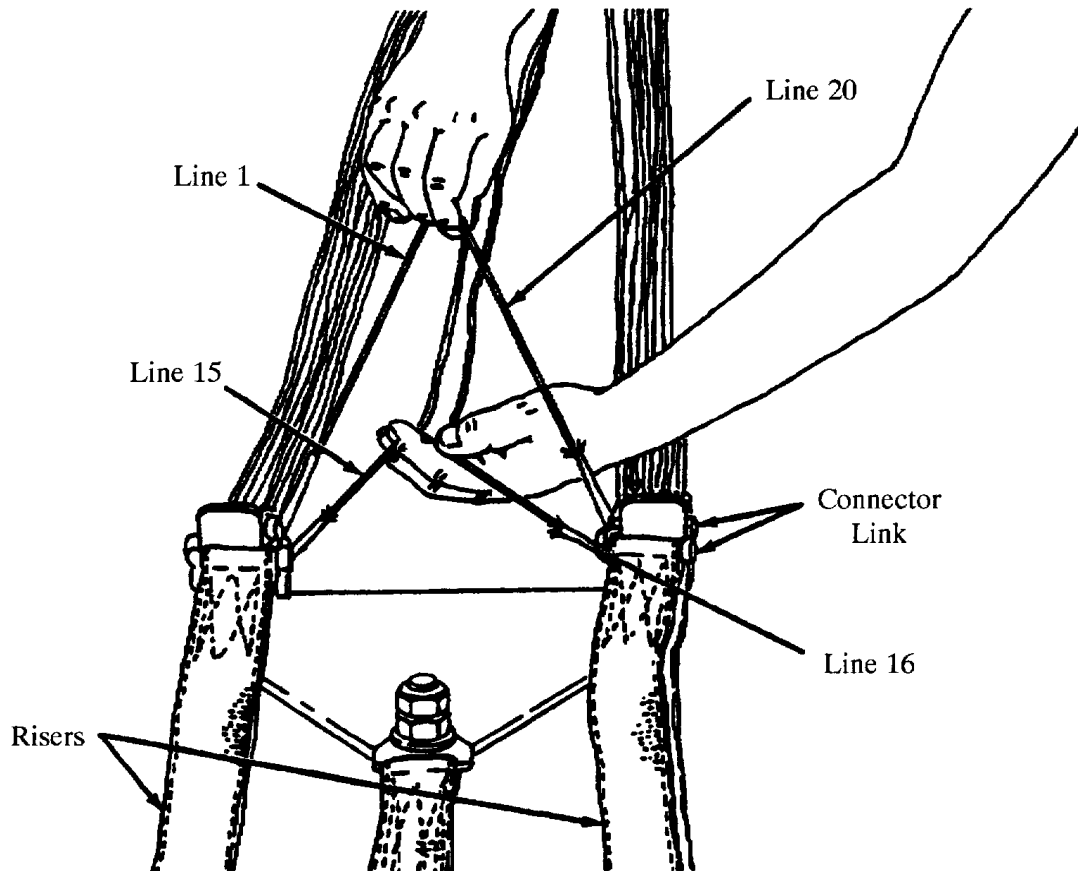

6. Assemble parachute components in accordance with WP 0004 00.
7. Parachute is now in proper layout, and ready for folding the gores.
8. Rigger check number 1.

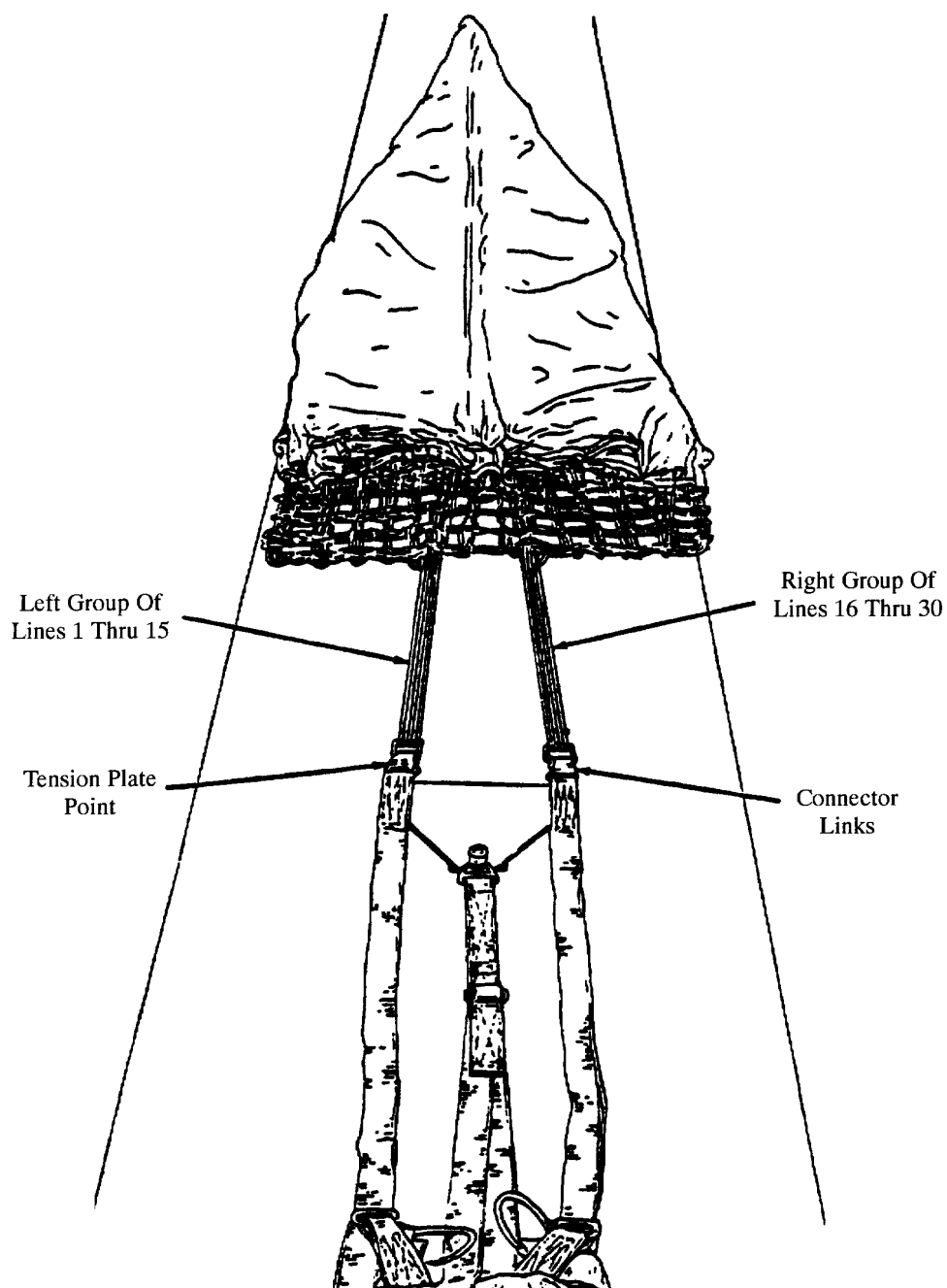

FOLDING THE GORES

After the parachute has been properly laid out, proceed as follows:

1. Move to the apex end of the table. Grasp the upper lateral band on both sides, with your fingers through the apex vent lines. Apply pressure toward the tension end of the table, until the upper lateral band is aligned (see illustration on following page).

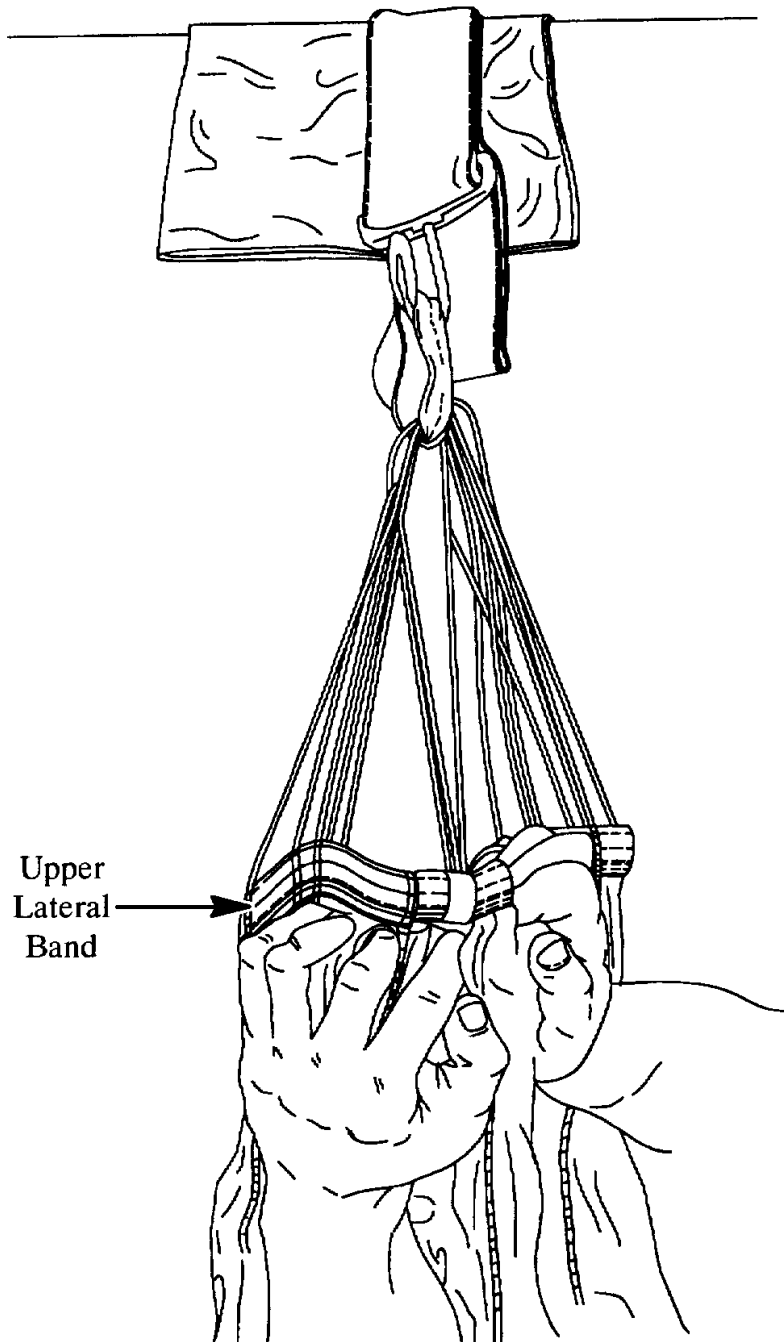

2. Move to the lower end of the table and apply first tension on the parachute until the suspension lines are taut and rise off the table.

3. Move to the lower lateral band of the canopy, with the right group of lines in the left hand. Lift the right group of suspension lines, with the left hand at the anti-inversion net. Hold top center anti-inversion net in position, with the right hand, and flip the right group of gores over the left group.

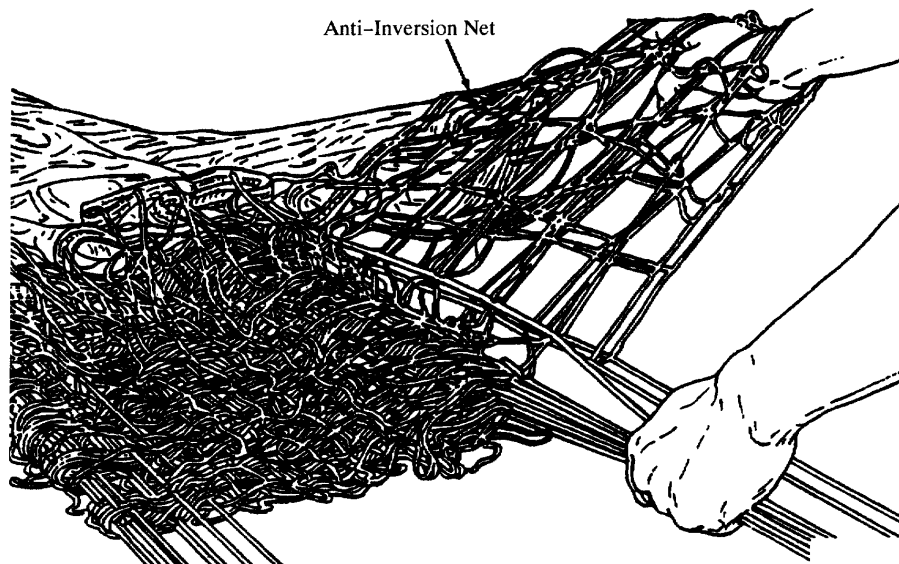

4. Start with line number 16 in the right hand. Pick up line No. 17 with the left hand and lift straight up until slack is removed from the lower lateral band. With a smooth continuous movement, bring the left hand over the head. When the gore inflates, place line No. 17 on top of line No. 16. Make certain the V-tabs are facing down and that the gore material folds to the right side.

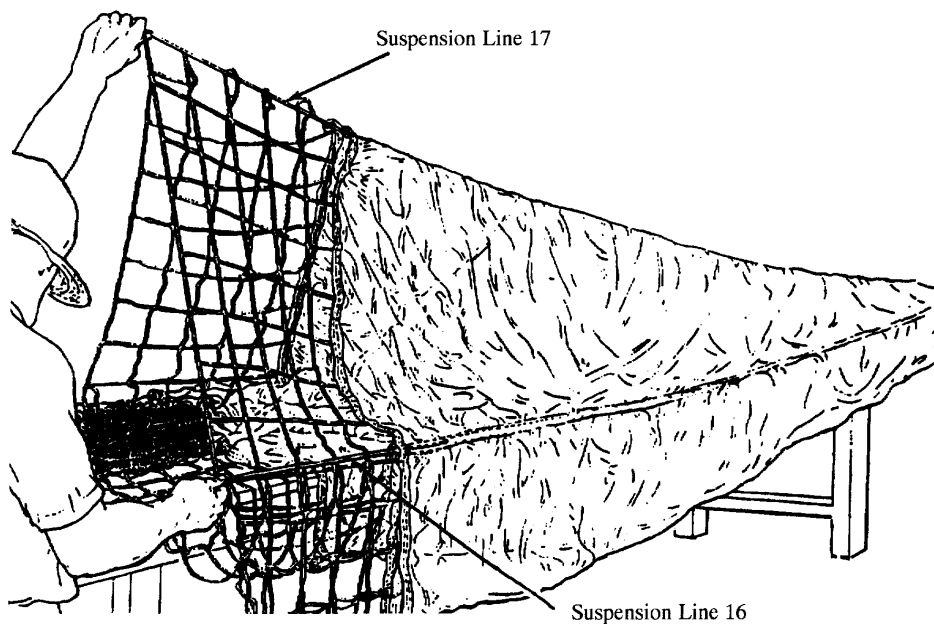

- Continue folding the gores until you reach line No.26. Pick up the control line and put it between suspension line No. 26 and No. 25. Continue folding the gores until you reach suspension line No. 30.

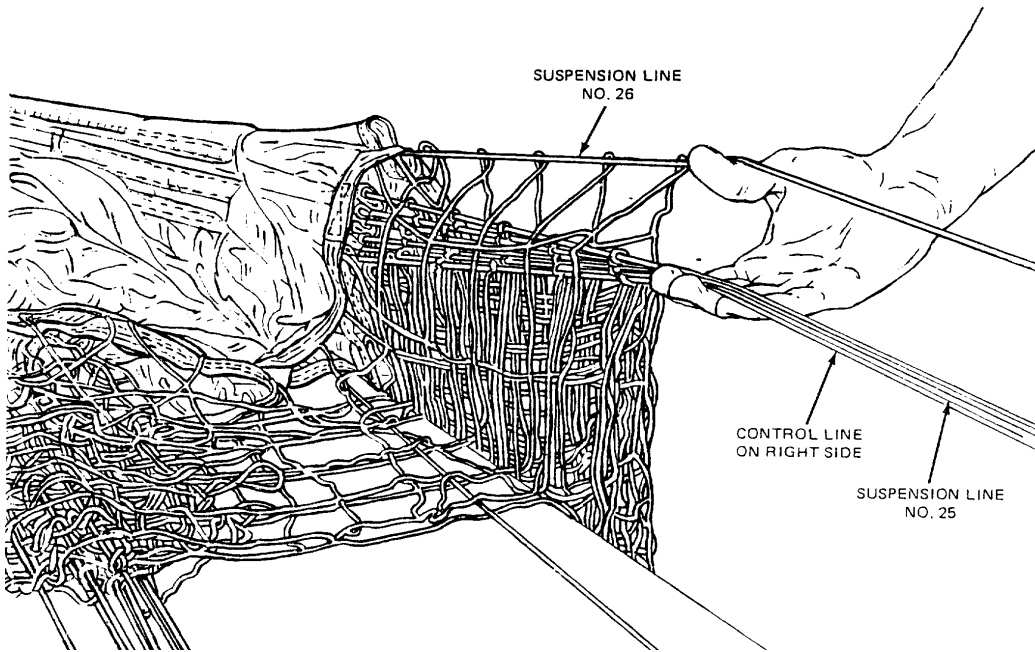

- Hold the right group of lines with the left hand. With the right hand (fingers pointing down) scissor the right group of lines between the 1st and 2nd fingers.

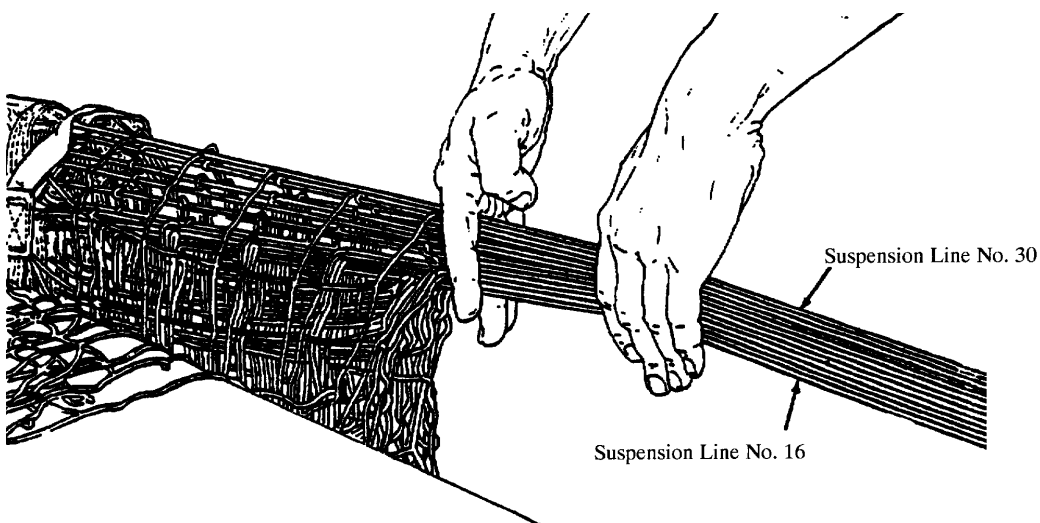

7. Rotate this group of lines clockwise until the fingers are tilted slightly upward, so that line No. 30 is on the bottom and line No. 16 is on the top.

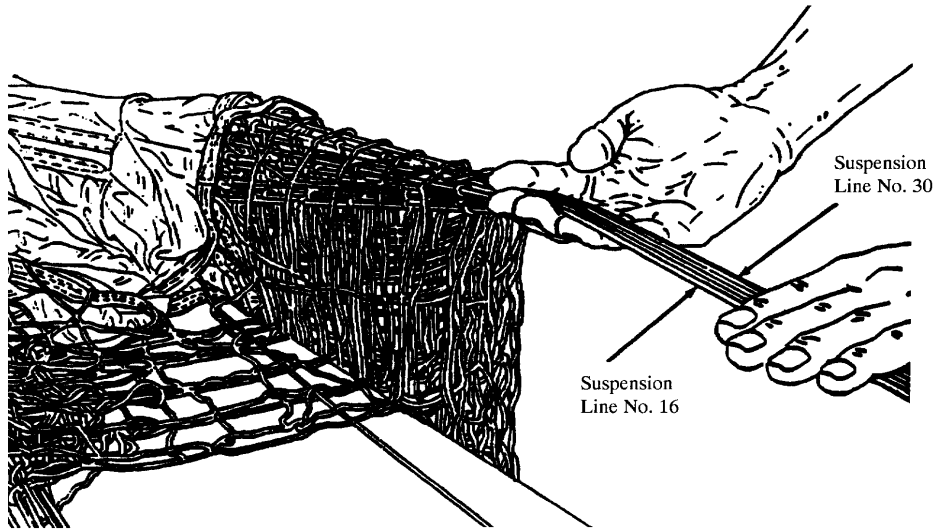

8. Starting with line 1, fold the left group of gores until you reach line No. 6. Pick up the control line and put it between suspension line No. 5 and No. 6. Continue folding the gores until you reach suspension line No.14. Pick up top anti-inversion net approximately 6- to 8-inches from suspension line No. 15. Raise it as you insert your elbow inside the anti-inversion net, placing suspension line No.15 over your left shoulder. Drape the last gore on the left and the next to last gore on the right.

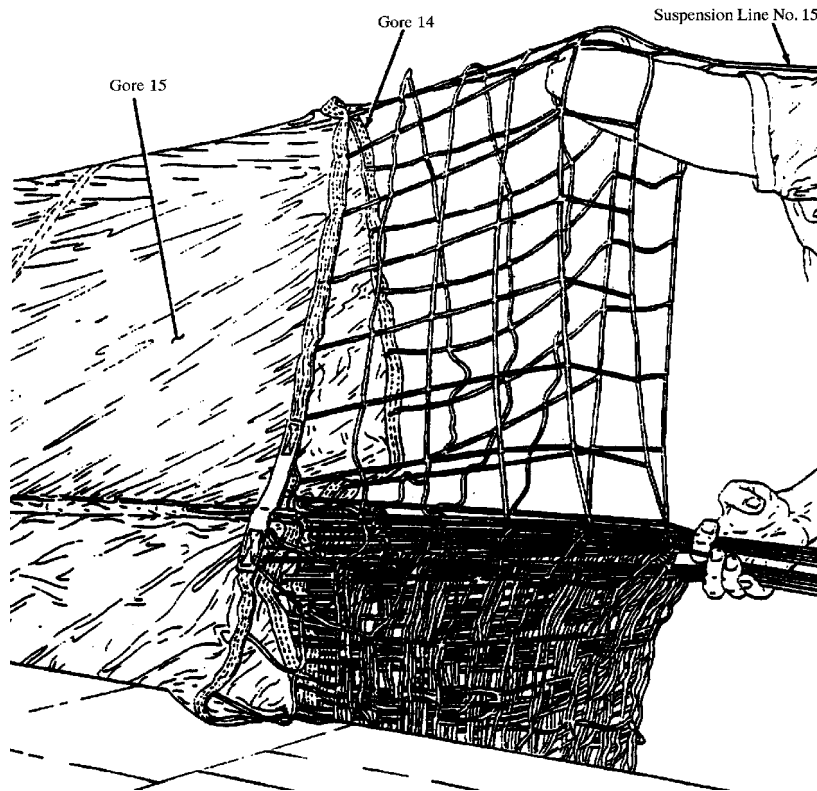

9. Insert the two groups of lines into a line separator, with the left group of lines in the left slot and the right group of lines in the right slot.

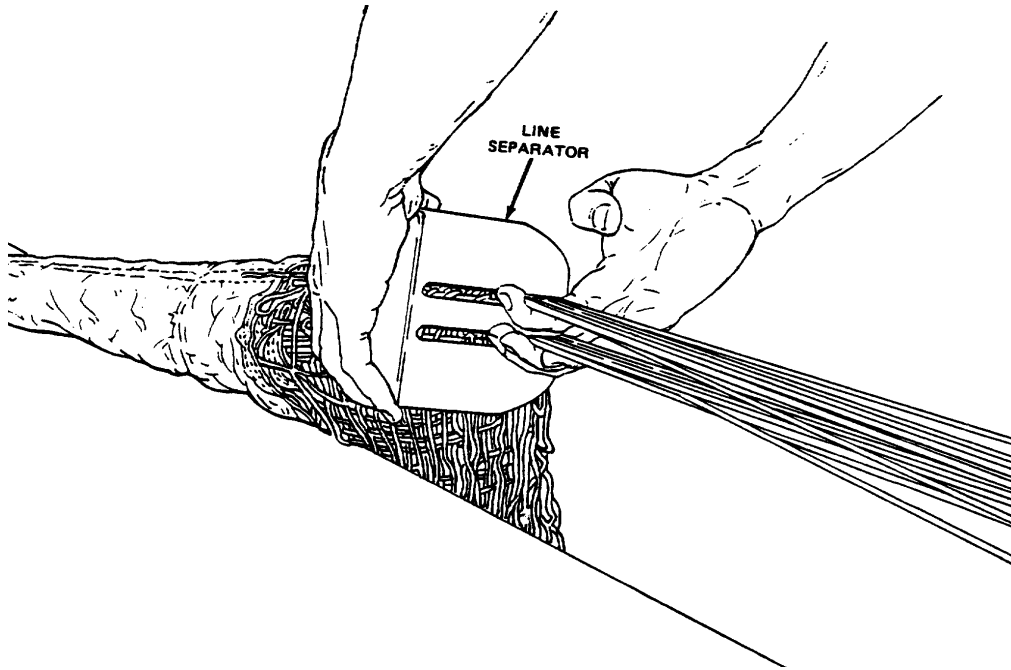

10. Hold base of line separator tight against canopy anti-inversion net; pull canopy off the table so that all gores drape to the right of the table.

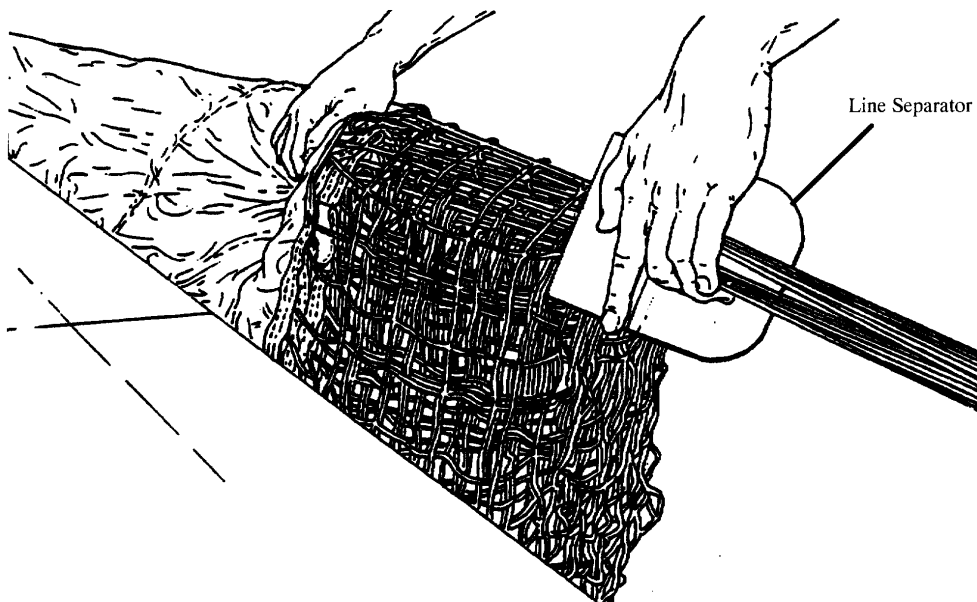

11. Turn the line separator counterclockwise so the base is down, and slide it back on the table.

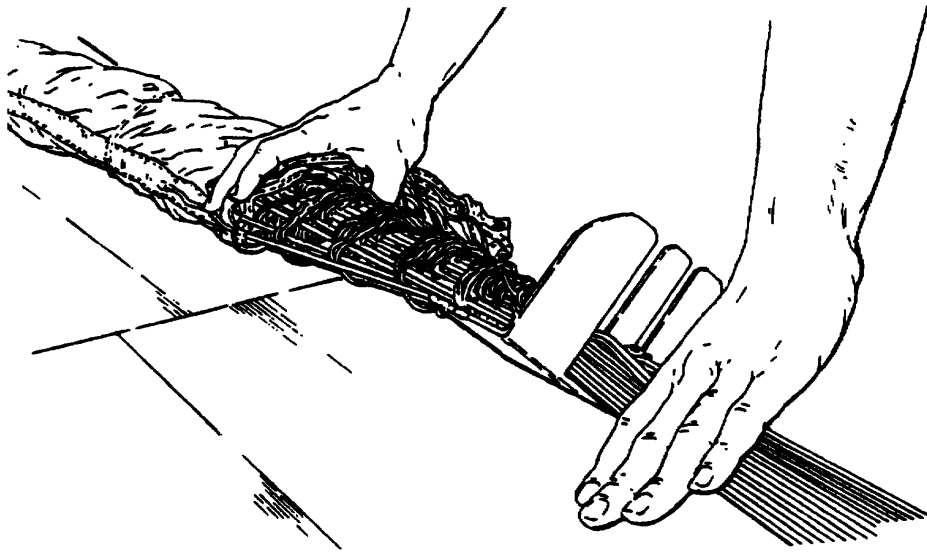

12. Place packing weight on suspension lines next to the separator.

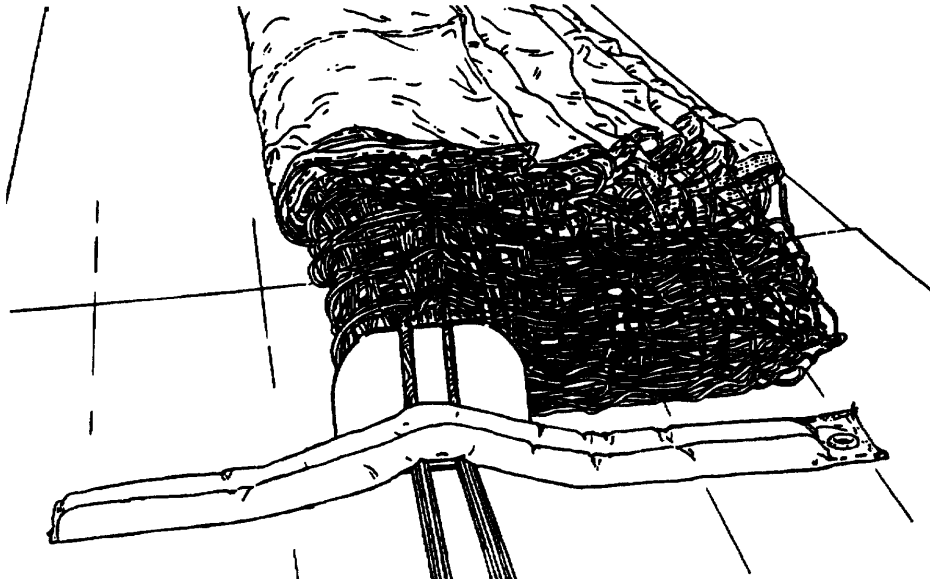

13. Apply additional tension to the suspension lines. After second tension is applied, rough dress top and bottom gore to ensure the last gore was sub-divided properly.

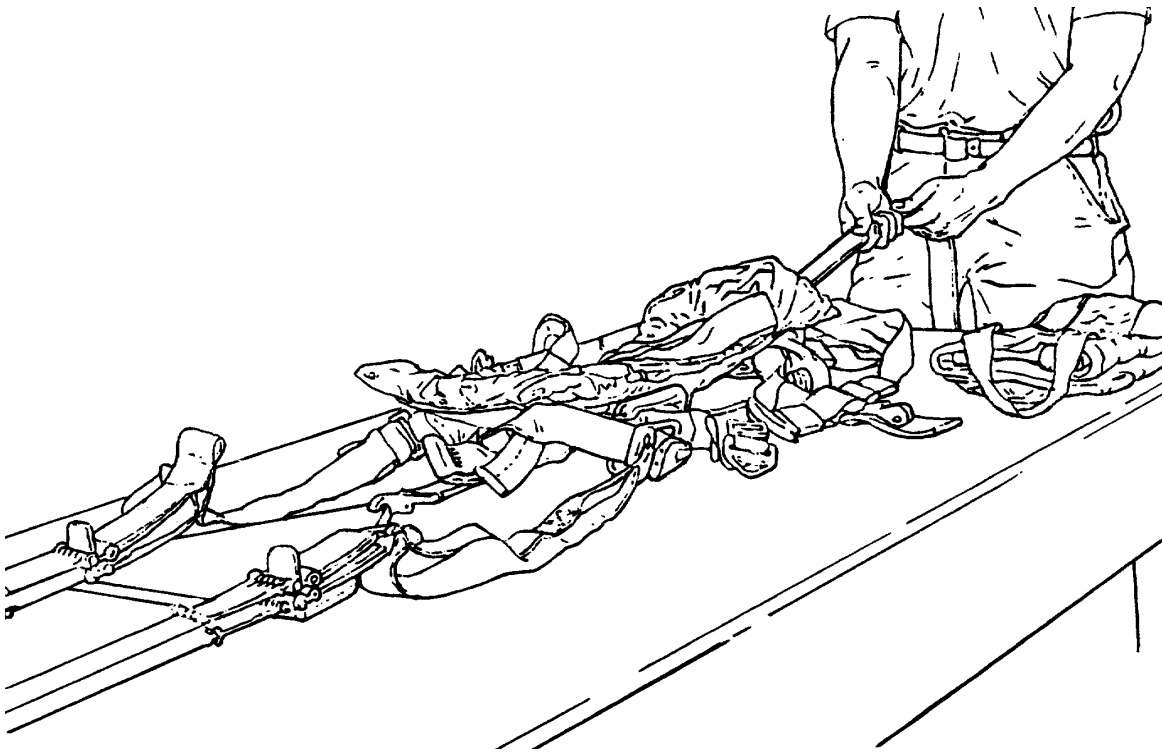

NOTE

Pull out the slack of the risers to even out the tension between the control lines and the suspension lines.

14. Placing the middle finger between the two groups of suspension lines, grasp the top part of the anti-inversion net and separate the left side from the right side. (Refer to illustration on next page.)

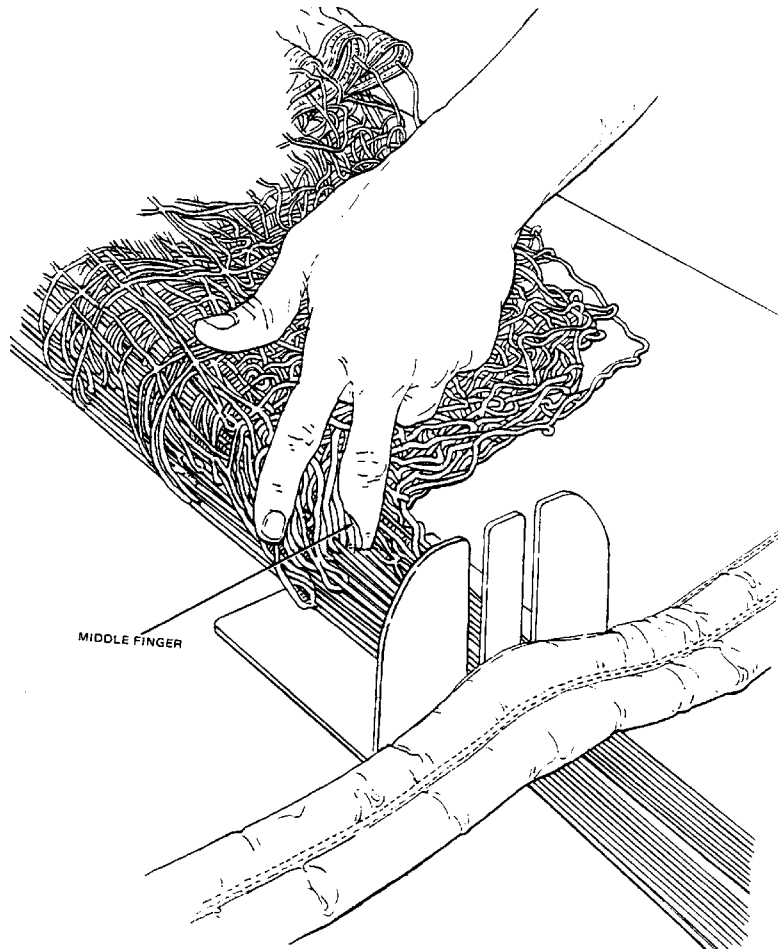

15. Continue separation of the canopy until you reach the apex.

WARNING

Dress each gore section and the anti inversion net to insure no foreign material is present. If foreign material is present, repeat fine dress procedures. Failure to do so could cause serious injury or death to the parachutist.

NOTE

Make sure that radial tape No.30 is on the top.

16. Fine dress the bottom gores by pulling gently on the left and right sides of the canopy, moving from the lower lateral band to the apex.

17. Dress the top gores by pulling gently, while moving to the lower lateral band. The canopy is now in a flat-fold.

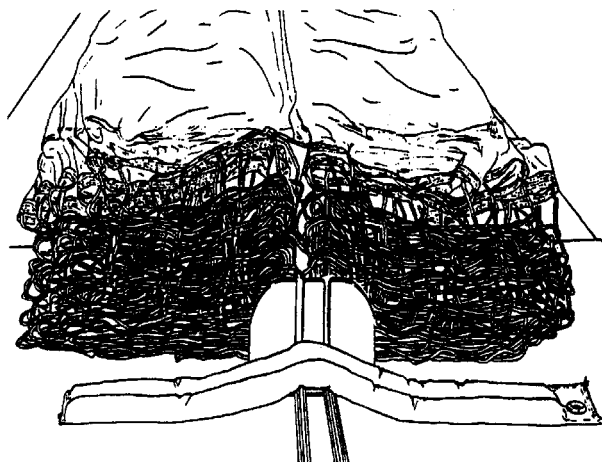

18. Fine dress the lower lateral band and anti-inversion net. Starting with the left group of gores, dress each gore section of the lower lateral band; work from the bottom to the top. Repeat the procedure for the right side.

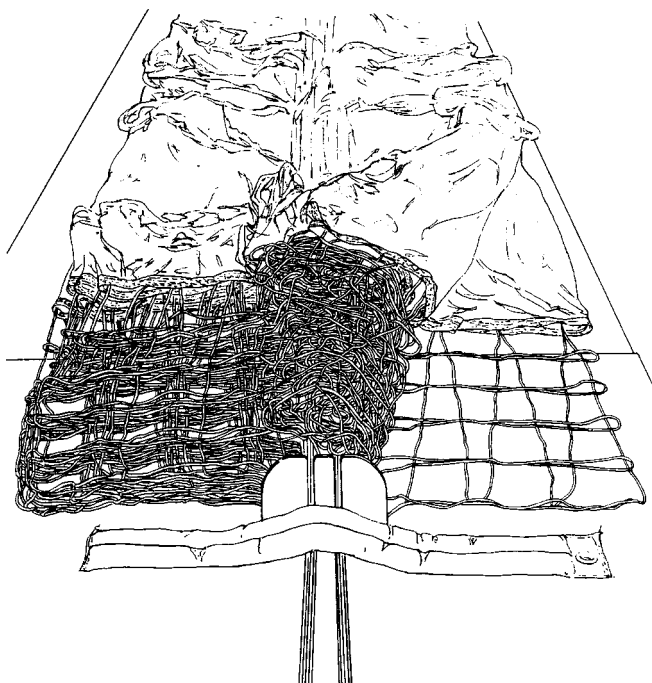

NOTE

Dress gore Nos. 25, 26, 27, 28, 29, 30, 1, 2, 3, 4, 5, and 6, above the orifice, by pulling the folded edges until they are aligned with the edges of the other gores. Count the gore edges at the top of the orifice to ensure that 15 gores are located on each side of the canopy.

19. This completes the flat-fold of the canopy.

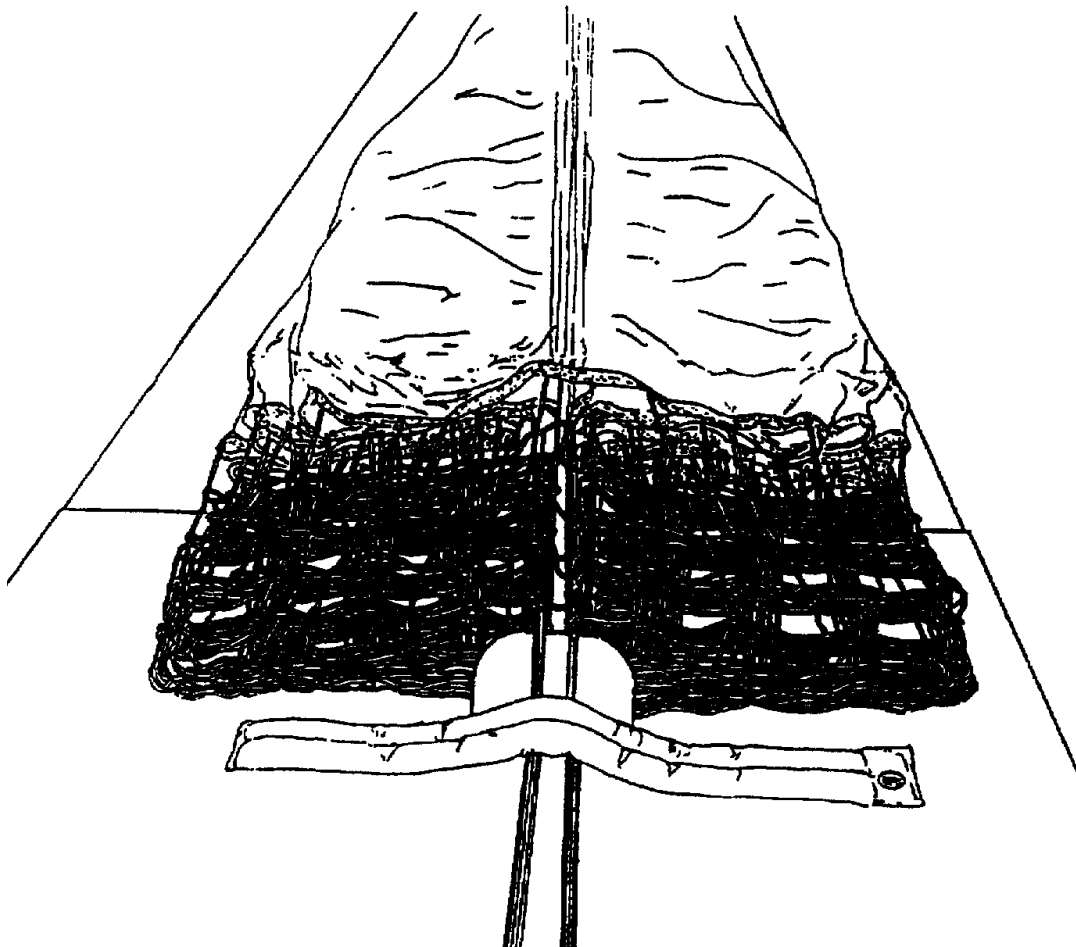

20. Raise the top radial tape, No.30, and check for a clear channel. Also check to ensure that the left control line is with the left suspension line group, and the right control line is with the right suspension line group.

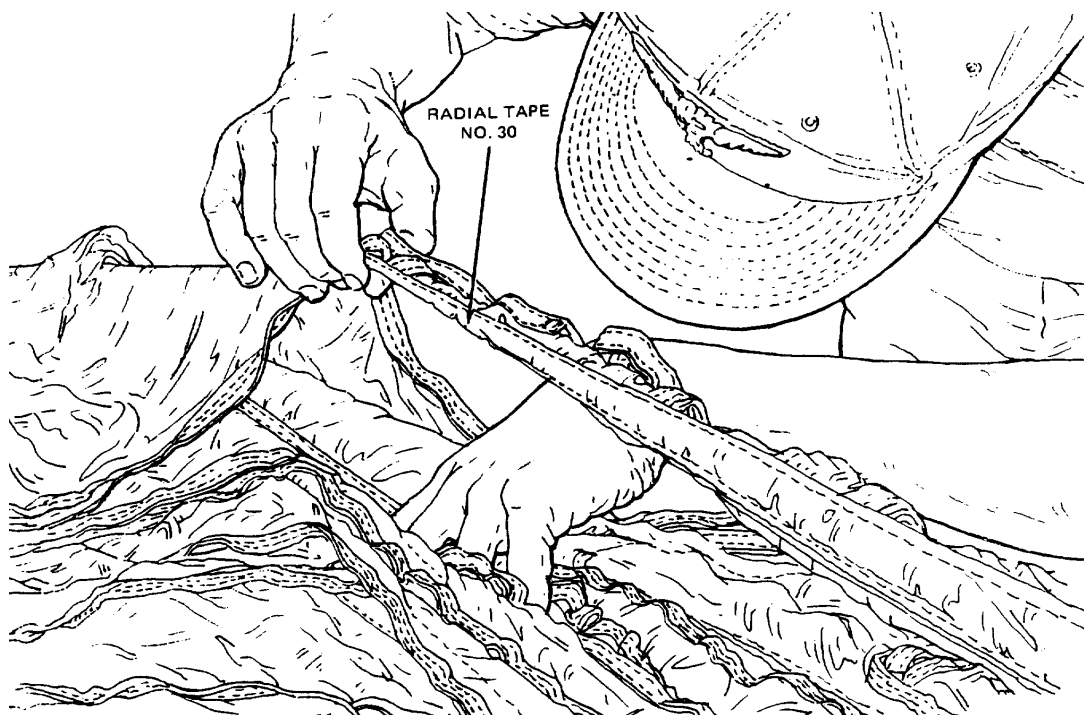

NOTE

If material is in the channel, repeat the fine dressing procedure.

21. Rigger check number 2.

LONG-FOLDING THE CANOPY

After flat folding, the canopy is ready for longfolding. Proceed as follows:

1. The anti-inversion net and the lower lateral band of the canopy will be folded 180 degrees, with the right group folded first, so the lower edges are parallel to each other and are slightly extended (approximately 2-inches) over the two groups of suspension lines.

2. Grasp the edges on the right side of the anti-inversion net with the left hand, and the lower lateral band in the right hand. Fold edges slightly over suspension lines/radial seam (approximately 2-inches).



3. Place the first packing weight on the lower lateral band.
4. Continue folding the right group in the same manner until you reach halfway up the canopy. Place the second packing weight.

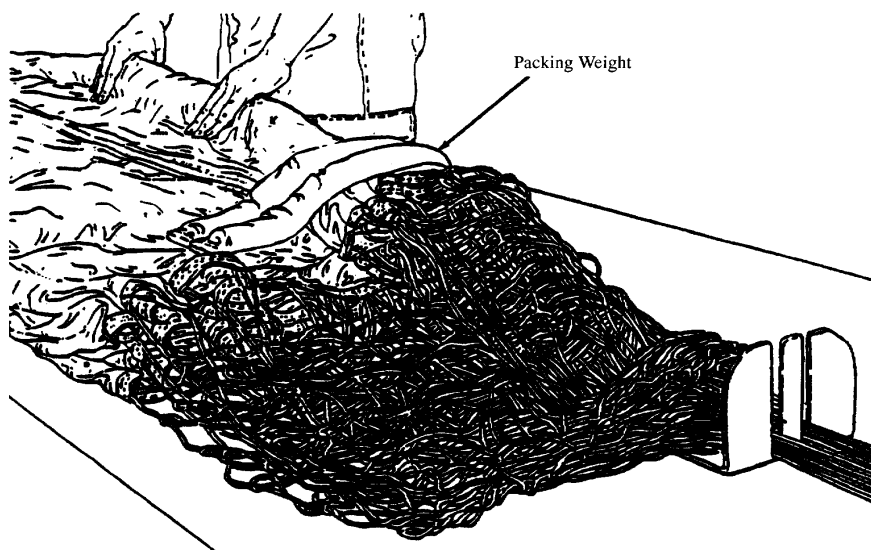

- Continue folding until you reach approximately 48-inches from the apex. Then place the third packing weight.

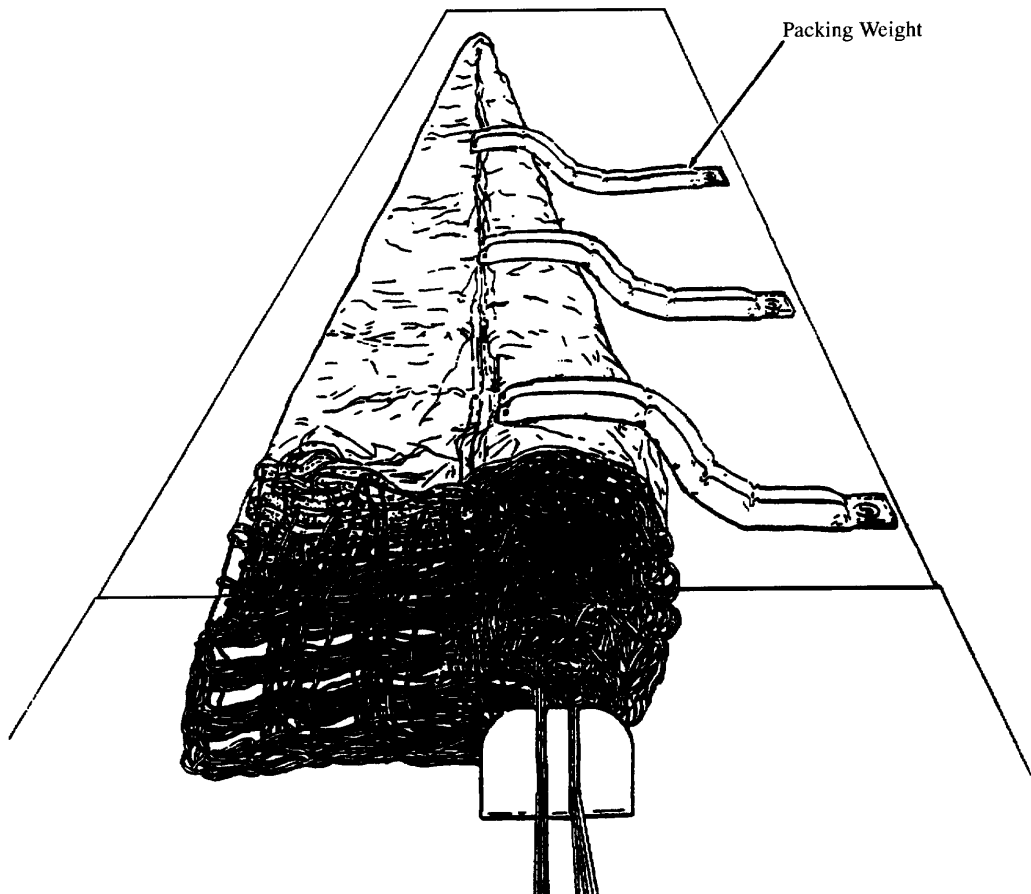

- Fold the left group of the anti-inversion net and lower the lateral band over the right group.
- Fold the left group of gores in a similar manner; adjust the packing weights to hold both groups of gores.

NOTE

After longfolding, ensure there is no rollback. The parachute should be approximately 10-inches-wide at the skirt (lower lateral band) and 6-inches-wide where the fold breaks near the apex.

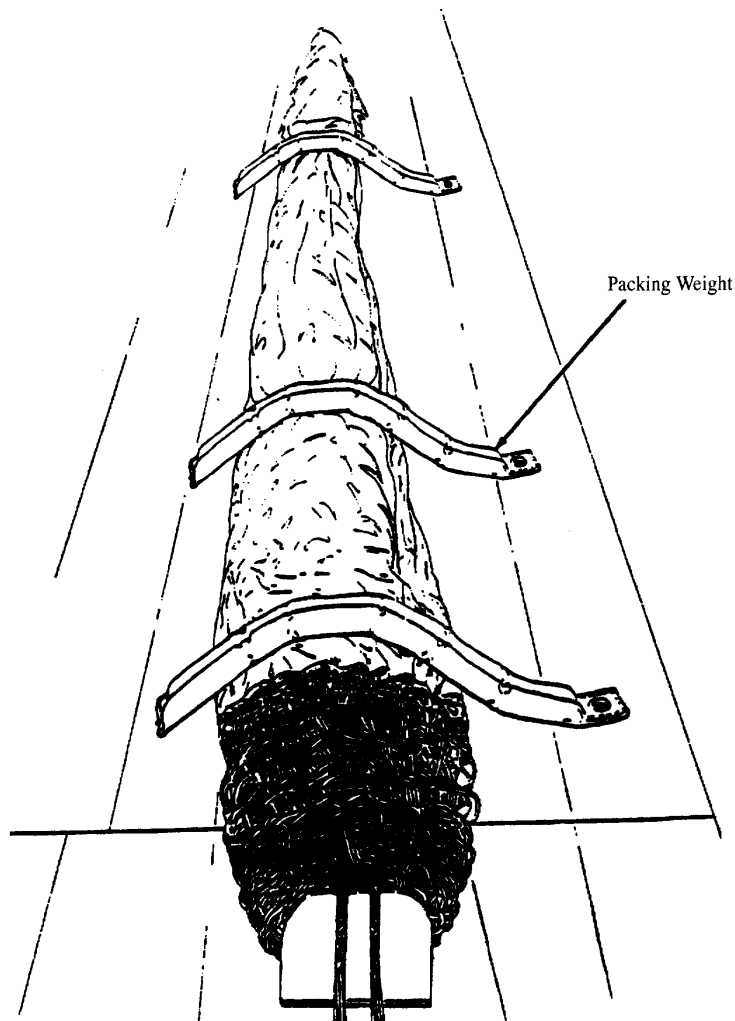

8. Longfolding is completed.

TYING THE STATIC LINE TO THE BRIDLE LOOP OF THE CANOPY

Before stowing the canopy in the deployment bag, the canopy must be attached to the static line buffer loop. Proceed as follows:

WARNING

Inspect the deployment bag and the entire static line, including that portion under the sleeve. Failure to do so may cause serious injury or death to personnel.

1. Pull the bottom of the deployment bag up through the opening of the deployment bag until the static line buffer loop and the breakcord attaching strap loop are visible.

- To secure the static line while stowing the canopy, S-fold the static line and roll the suspension line protector cover around the folded line. Secure the ends of the protector cover with rubber retainer bands.

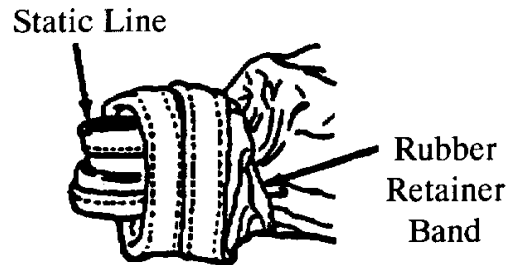

- For the USL, double a 36-inch length of Type I, 1/4-inch, cotton webbing. Pass one end of the doubled webbing through both plies of the static line buffer loop, through the bridle loop of the canopy, and back through both plies of the static line buffer loop.

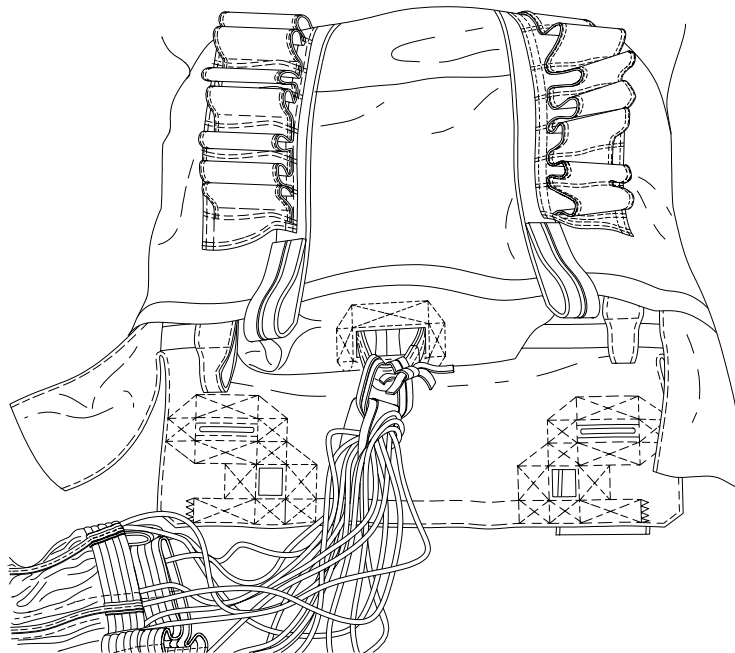

- For the standard static line, double a 36-inch length of Type I, 1/4-inch, cotton webbing. Pass one end of the doubled webbing through the static line buffer loop, through the bridle loop of the canopy, and back through both plies of the static line buffer loop.

- Secure the ends of the cotton webbing, over the buffer loop, with a surgeon's knot and locking knot. Allow approximately a 3-inch loop between the static line buffer loop and the bridle loop. Trim the ends to approximately 2-inches.

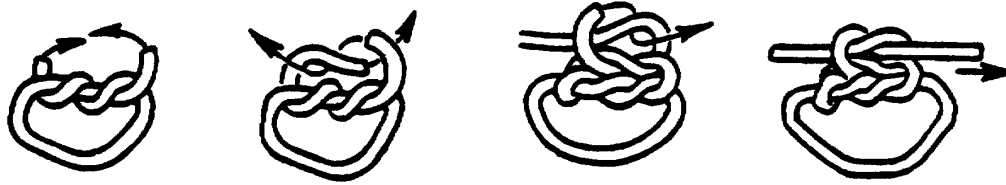

- Rigger check number 3.

STOWING THE CANOPY

Proceed to stow the canopy as follows:

- Release tension and unhook the bridle loop from the apex hook. Hold the deployment bag open with the right hand and grasp the canopy near the apex. Place the apex of the canopy into the upper right corner of the deployment bag.

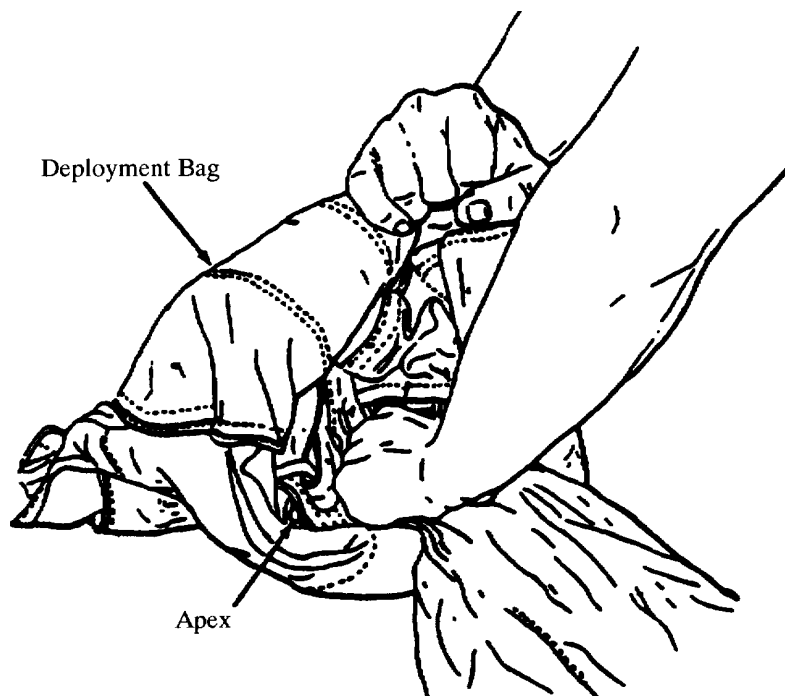

2. Grasp the canopy with the left hand, approximately the width of the deployment bag, and place the second stow in the upper left corner.

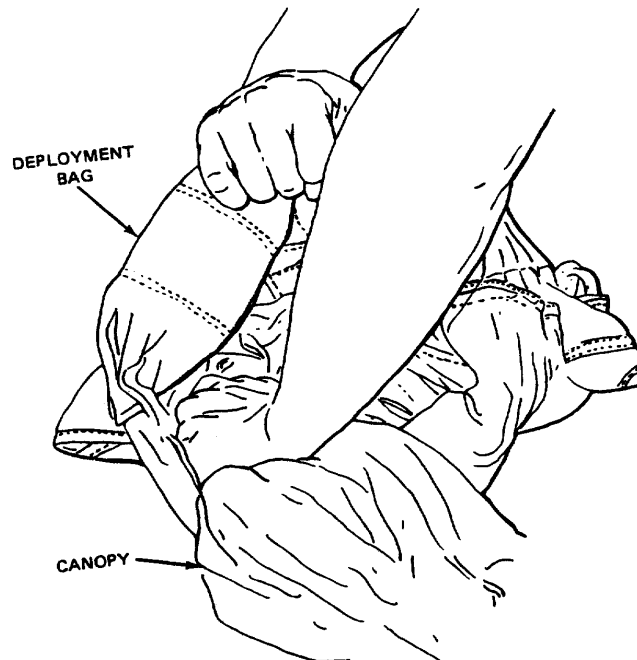

NOTE

Move the packing weights down the canopy, as necessary.

3. Continue stowing the canopy, in alternating sides of the deployment bag, until the lower lateral band and the anti-inversion net are reached.

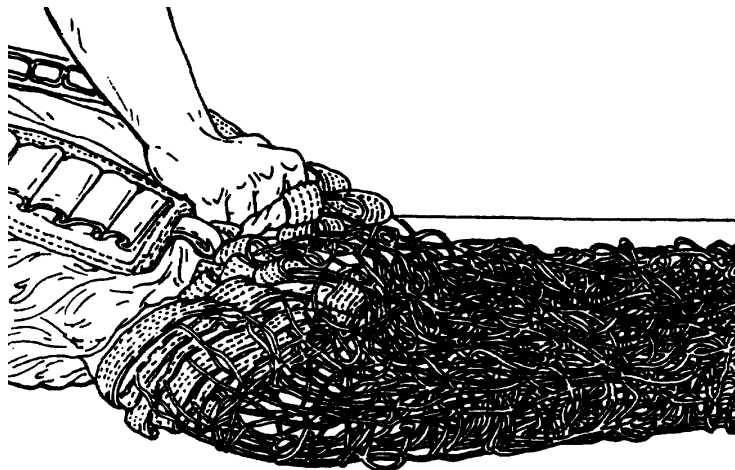

4. Grasp the lower lateral band and slide it into the center of the deployment bag.

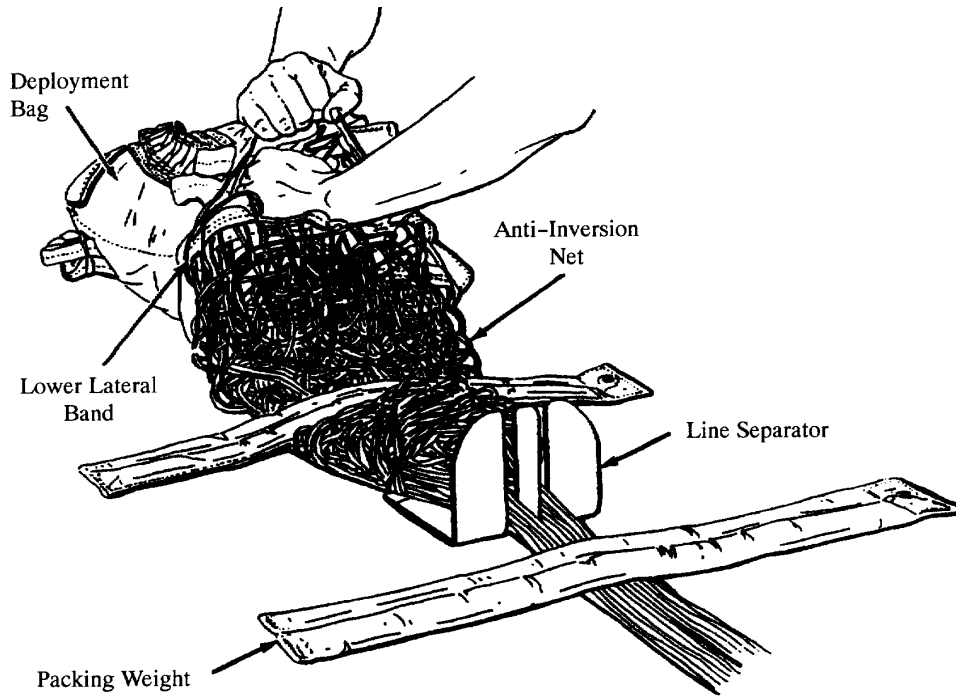

5. With the middle finger of the right hand, placed between the left and right group of suspension lines, grasp the anti-inversion net.
6. With the left hand, move the packing weight and line separator. Then place the left hand on the mouth of the deployment bag; with the right hand, slide the anti-inversion net into the center of the deployment bag.

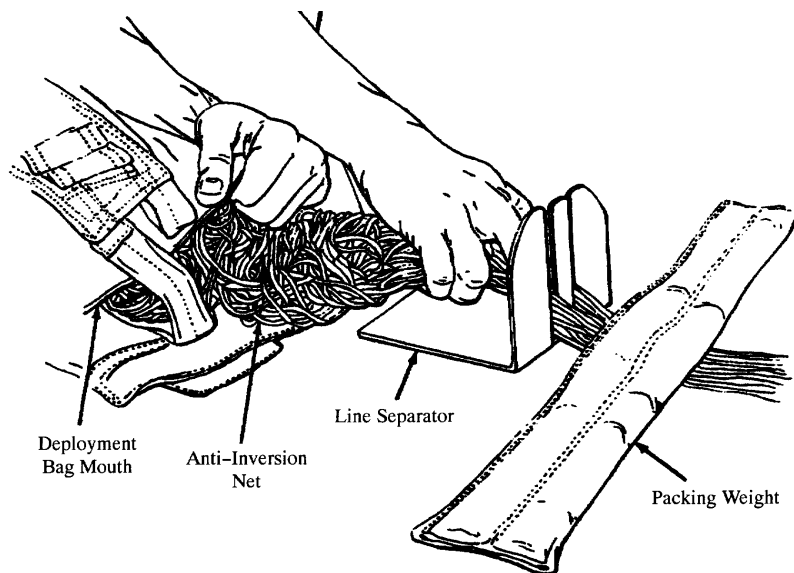

7. Turn the deployment bag upright, with the static line end down. When the entire canopy and net are stowed, the suspension lines should be centered on top of the deployment bag.

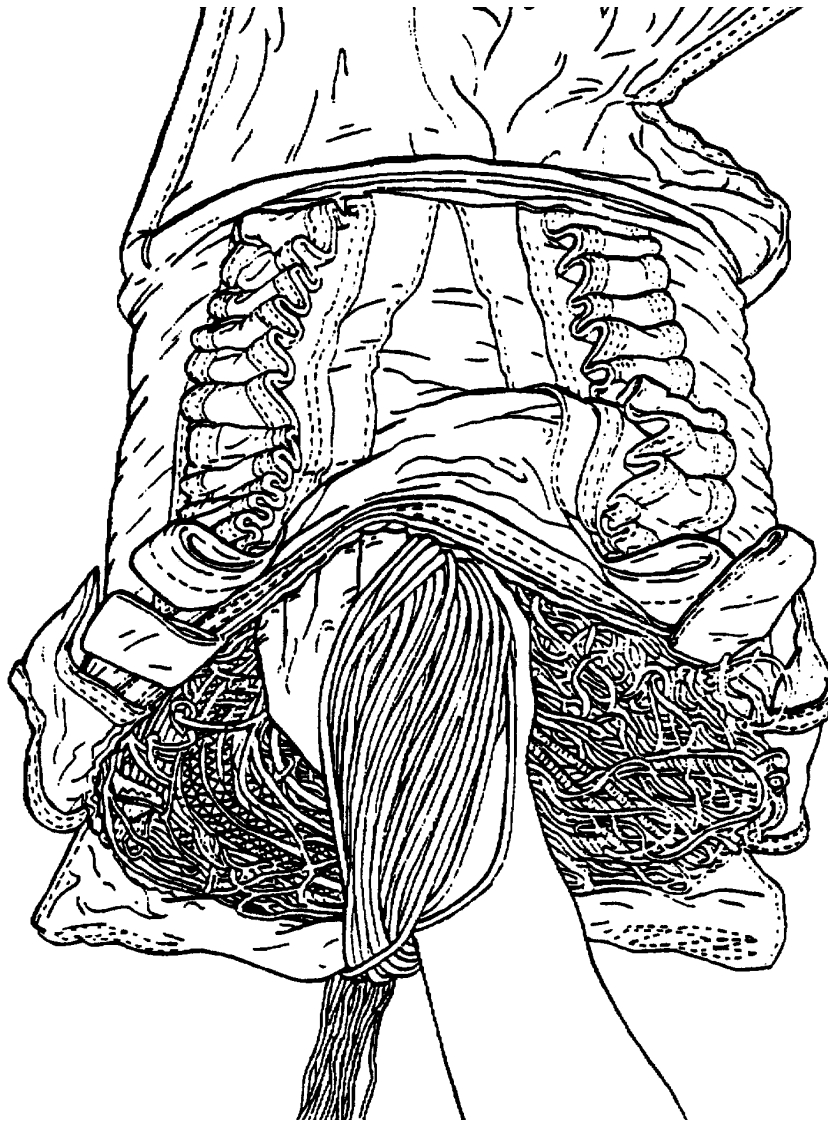

CLOSING THE DEPLOYMENT BAG AND STOWING THE SUSPENSION LINES

After the canopy stow has been completed, continue as follows:

1. Pull the suspension lines over the top center of the deployment bag; fold the side flaps of the deployment bag over the stowed canopy anti-inversion net and fold the locking stow panel over the side flaps. Insert the locking stow loops and connector line tie loops through the slots in the locking stow panel.

2. Insert the stow hooks in the locking stow loop to hold the deployment bag closed. Insert a packing paddle through the connector link tie loops and lay the deployment bag down.

NOTE

Before making the first locking stow, pull the slack out of the risers to even the control lines with the suspension lines.

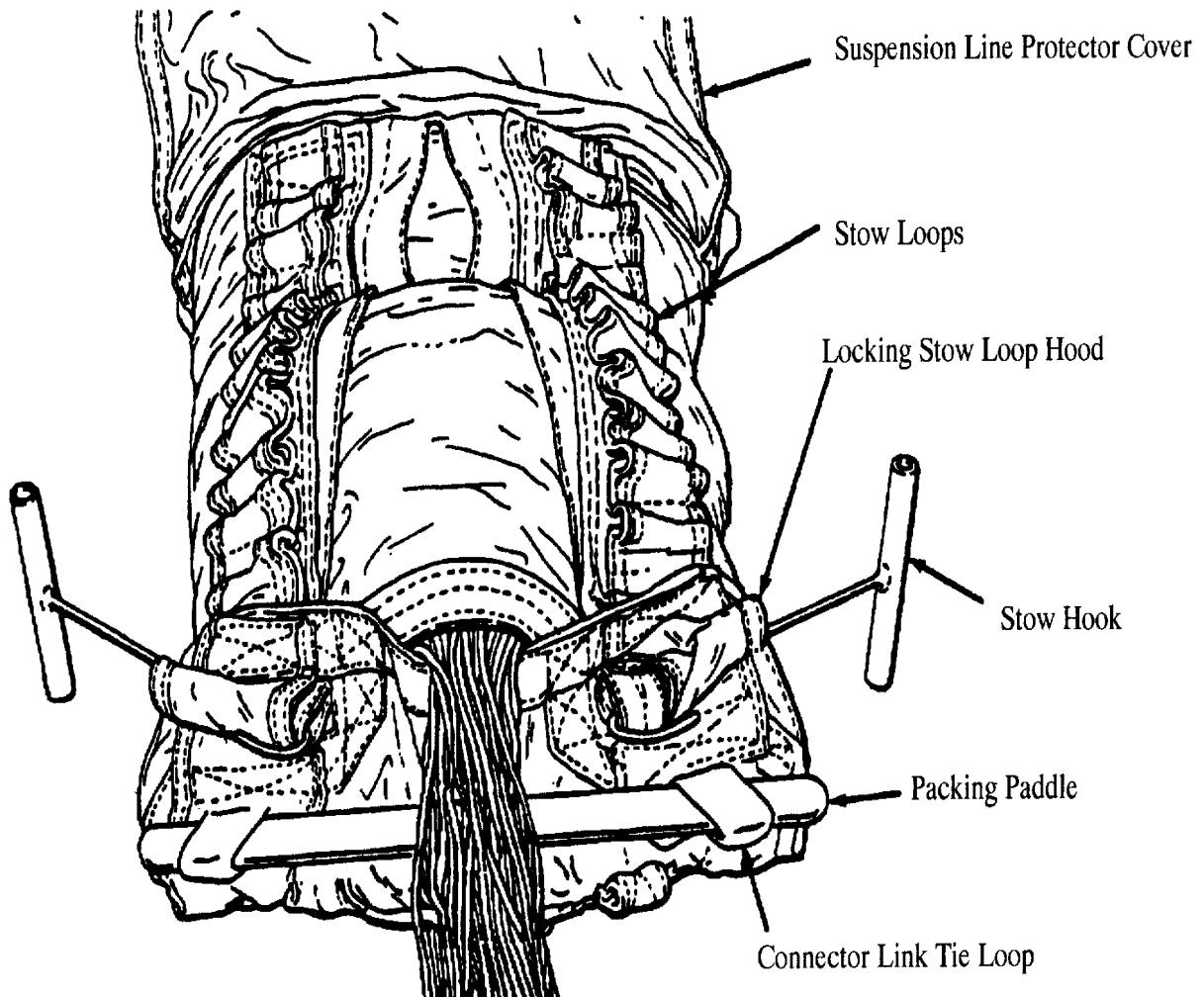

3. Grasp all the suspension lines and form a locking stow loop that reaches from the center of the deployment bag to 2-inches beyond the hoods of the right locking stow loop.

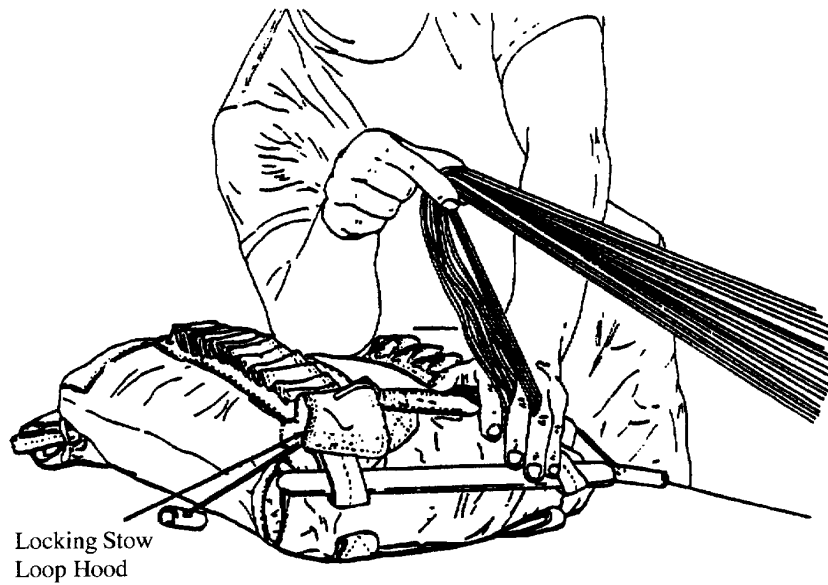

4. Insert the right stow hook through the loop formed by the suspension lines. Ensure the stow hook is around all of the suspension lines.

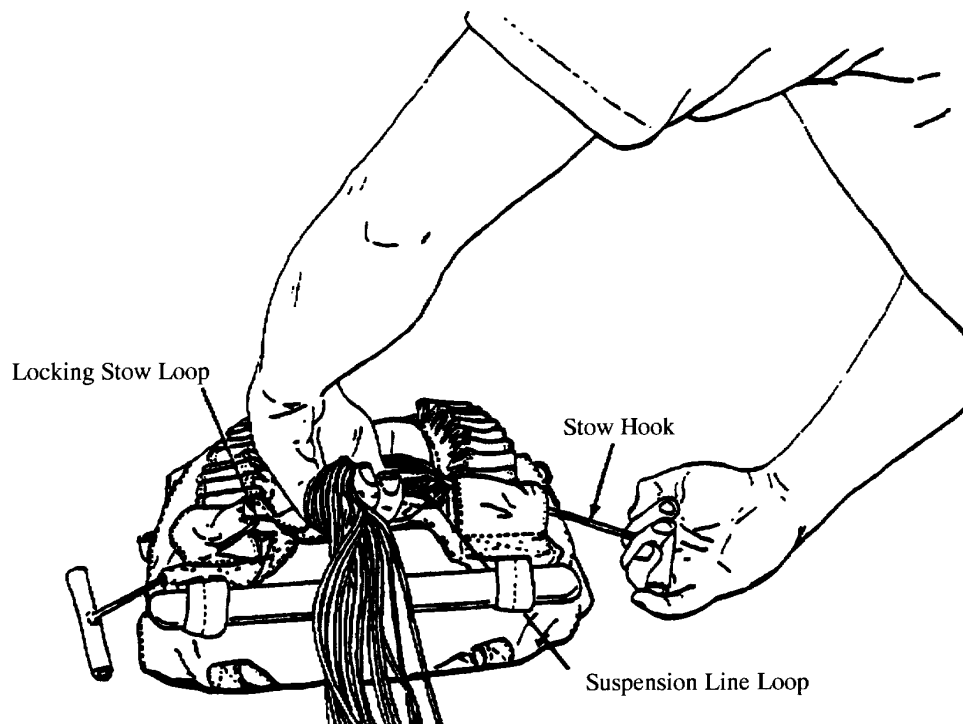

5. Pull the suspension line loop through the right locking stow loop. The end of the stow should extend 2-inches beyond the hood of the locking stow loop.

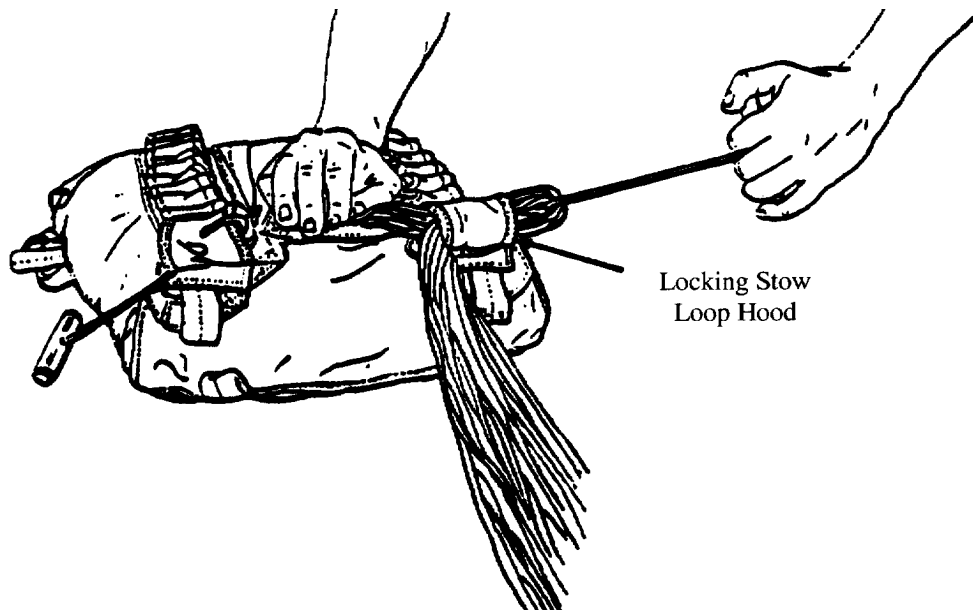

6. Grasp the suspension lines, approximately the width of the bag, and form a second loop that extends 2-inches beyond the hood of the left stow loop.
7. Insert the left stow hook through the formed suspension line loop. Ensure the stow hook is around all of the suspension lines.

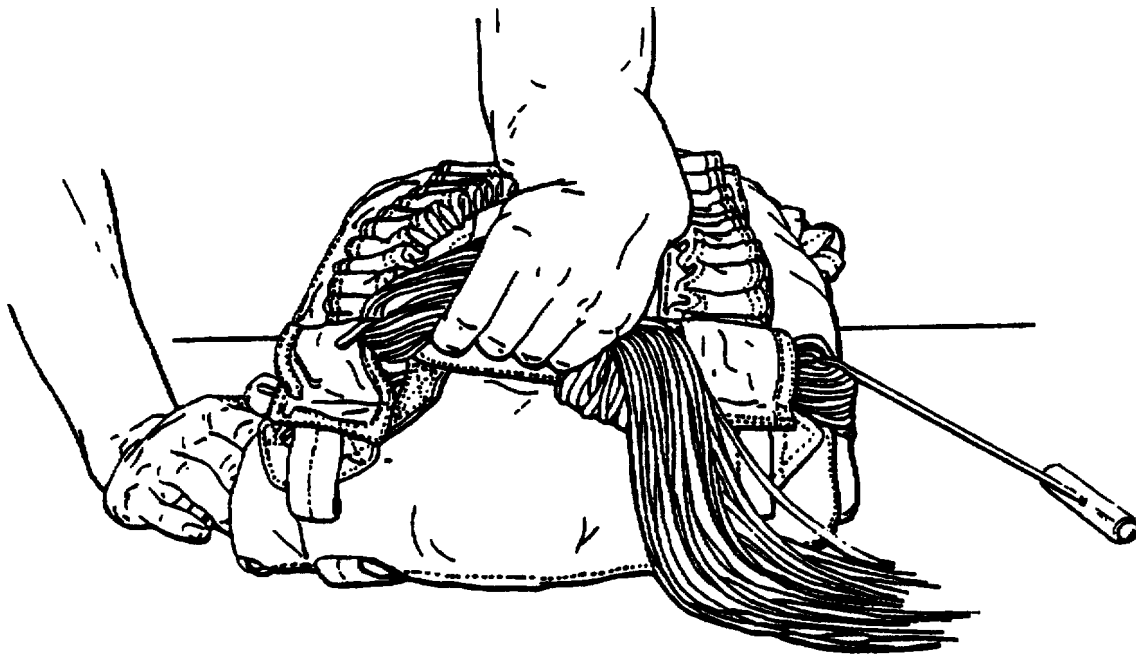

- Pull the suspension line loop through the left locking stow loop. The end of the stow should extend 2-inches beyond the hoods of the locking stow loop.

NOTE

Flatten the deployment bag.

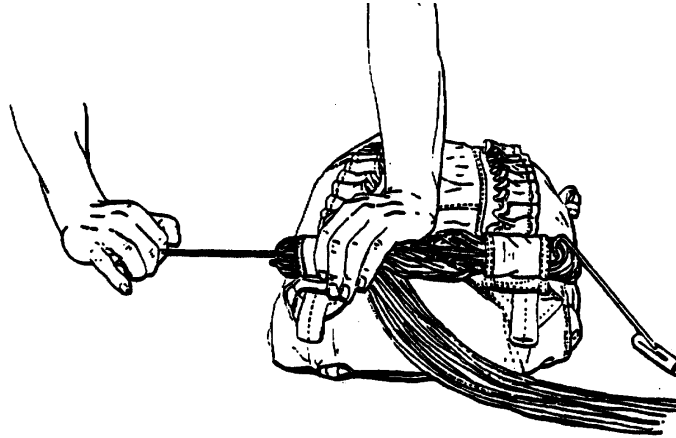

- Extend the suspension lines to the upper right corner of the deployment bag. Form the first regular stow.

NOTE

Ensure the stow hook is around all suspension lines when making stows. Regular stows should extend through the stow loops to the outer edge of the reinforcement panels, but not more than 1-inch beyond the outer edge of the stow loop.

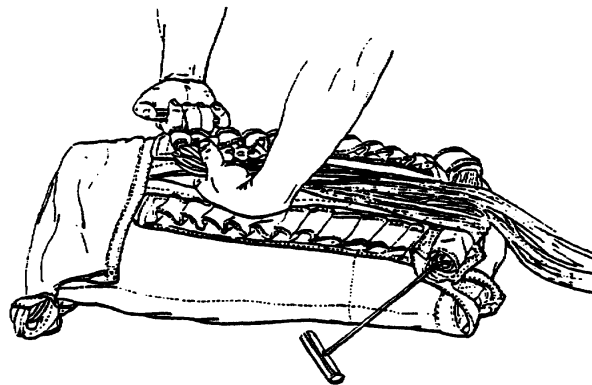

10. Using a stow hook, make the first regular stow in the upper right stow loop.

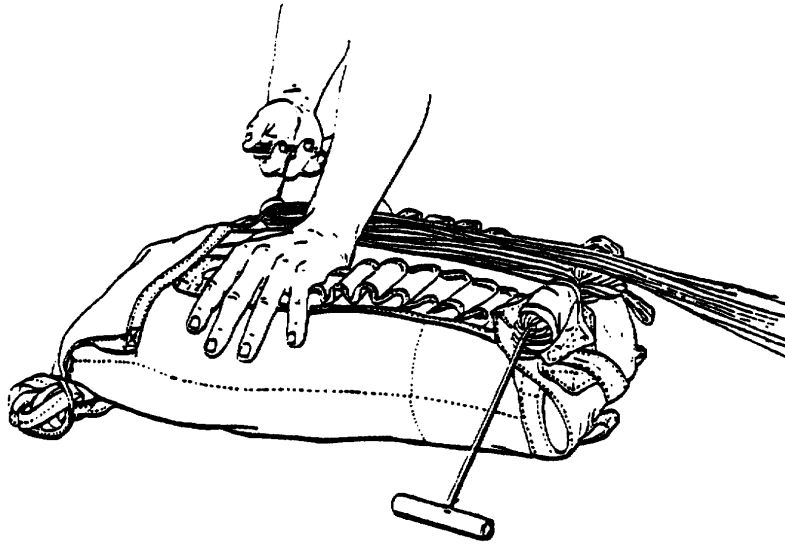

11. Rigger Check number 4.
12. Rotate the deployment bag one quarter-turn clockwise.
13. Grasp the suspension line, approximately the width of the deployment bag; slide the bag on the table and form the second regular stow in the upper left corner of the bag.
14. Using a stow hook, make a second regular stow in the upper left corner.

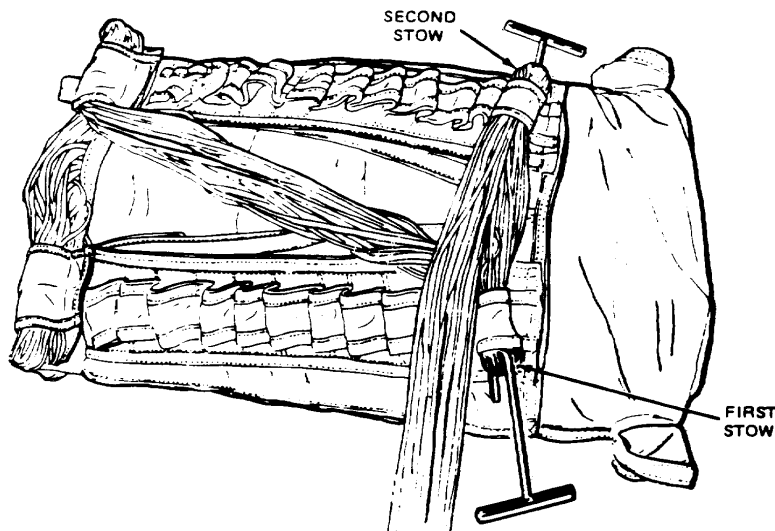

15. Continue alternating the stows from right to left until approximately 8- to 10-inches of suspension lines are left unstowed.

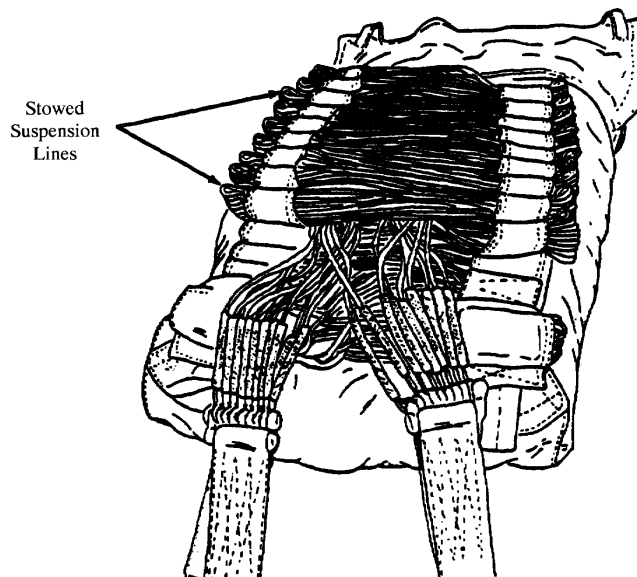

16. Rigger check number 5.

NOTE

There should be a minimum of 8 stows on each panel.

17. Remove the connector links from the tension plate.
18. Fold the excess slack from the remaining suspension lines over the stowed suspension lines.

TYING CONNECTOR LINKS AND SUSPENSION LINE PROTECTIVE COVER

To secure the packed deployment bag, continue as follows:

1. Unroll suspension line protector cover and cover suspension lines.

NOTE

Ensure the risers are still in proper layout.

2. Using a 14-inch length of type I, 1/4-inch, cotton webbing, pass an end through the right bottom connector link tie loop, ensuring the control lines are to the inside, through the right pair of connector links, through the top right connector link tie loop, and through the cover tie loop.

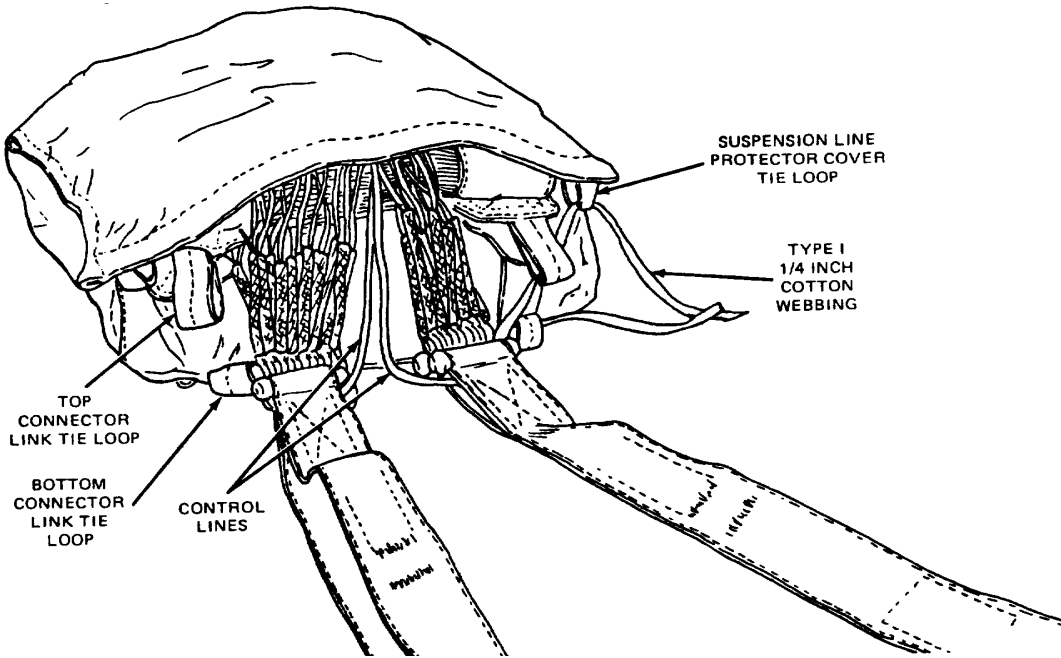

3. Secure all tie loops and connector links together with a surgeon's knot and a locking knot. Cut excess webbing; leave the end approximately 2-inches long.
4. Secure the left tie loops and connector links using procedures in steps 2. and 3., above.

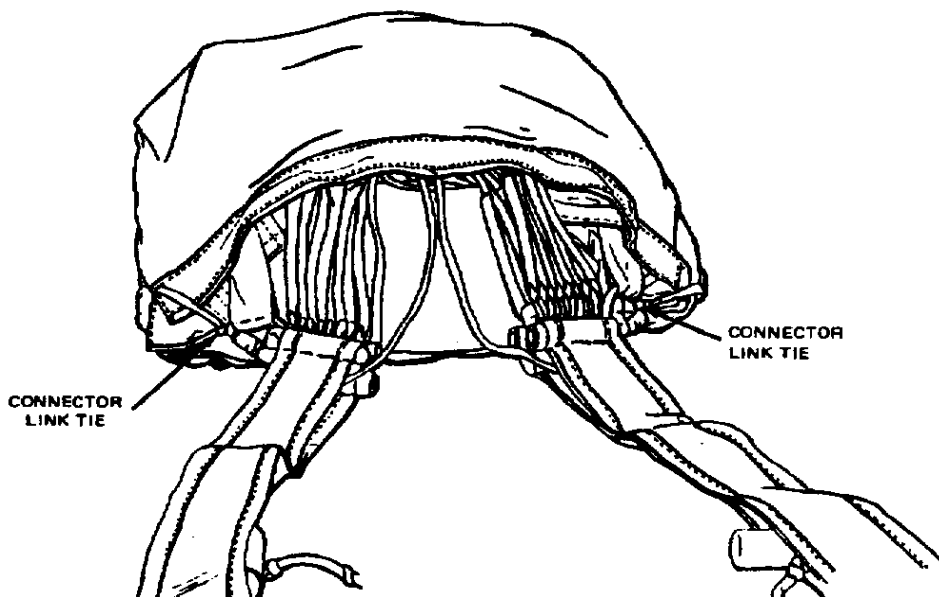

5. Enter deployment bag number in the NAVWPNS or NAWCWPNNS Premeditated Parachute Record or the DA Form 3912 log record book.

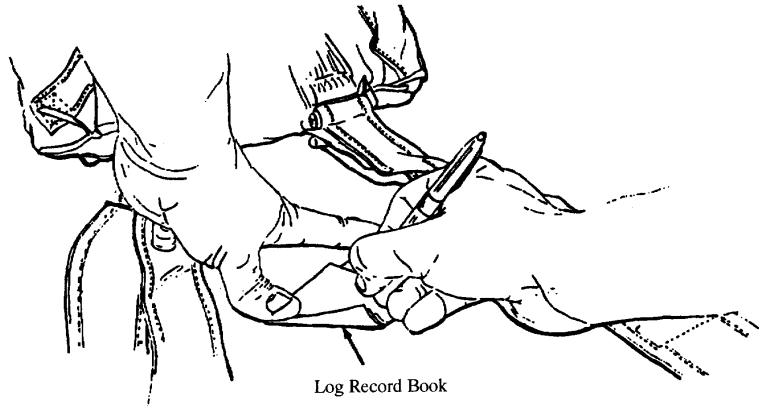

CLOSING THE PACK TRAY

To stow the packed deployment bag in the pack tray, proceed as follows:

1. With the right hand, hold the risers in place next to the canopy release assembly. With the left hand, grasp the top edge of the pack tray. Slide the pack tray forward approximately halfway up the risers. Spread the pack tray flaps.

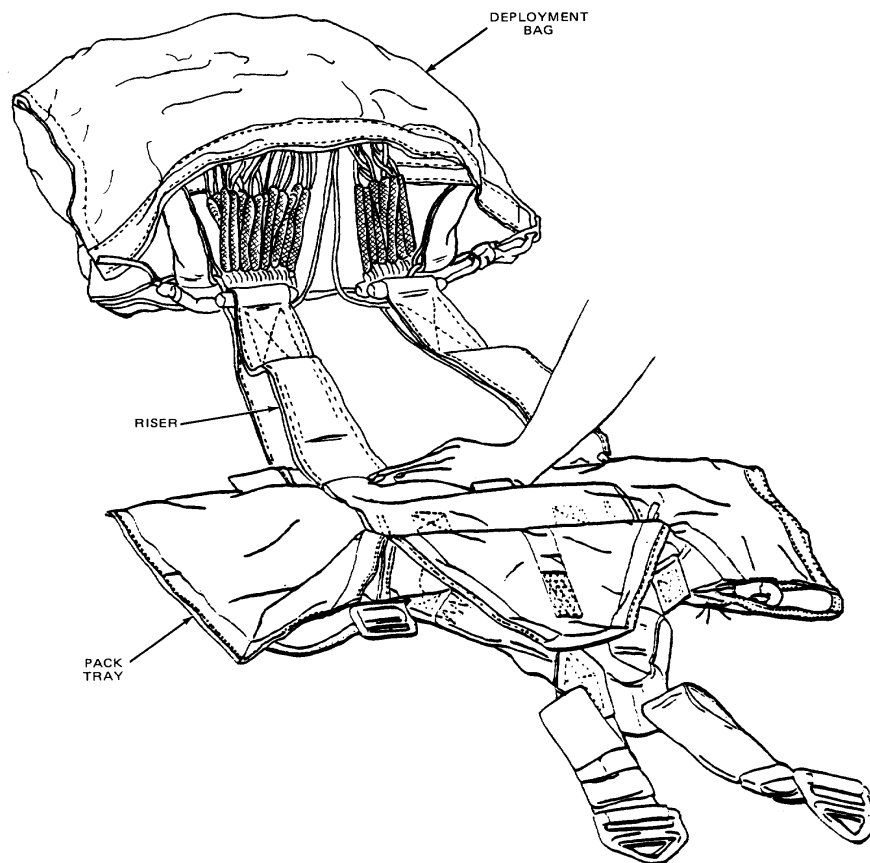

2. Slip the risers through the riser slots in the upper flap of the pack tray. U-fold the risers onto the pack tray.

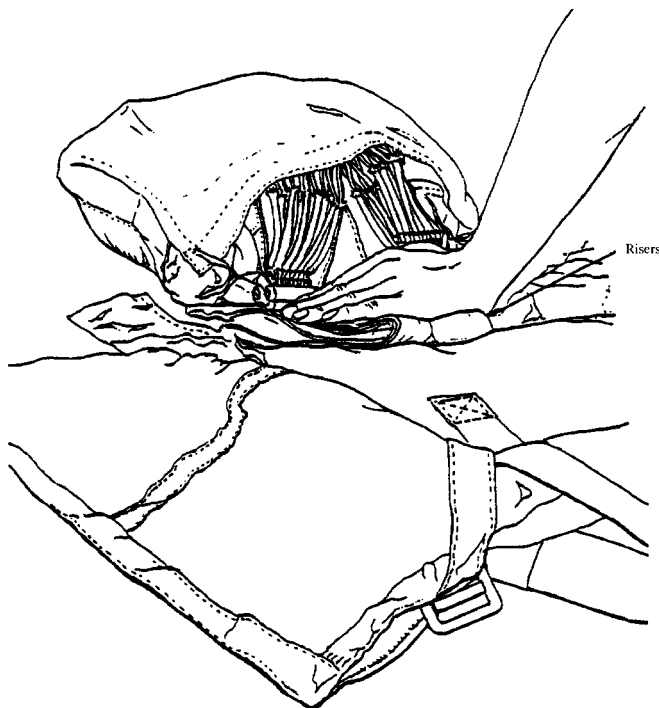

3. While holding the folded risers in place, grasp the static line at the end of the deployment bag, and rotate the bag onto the pack tray.

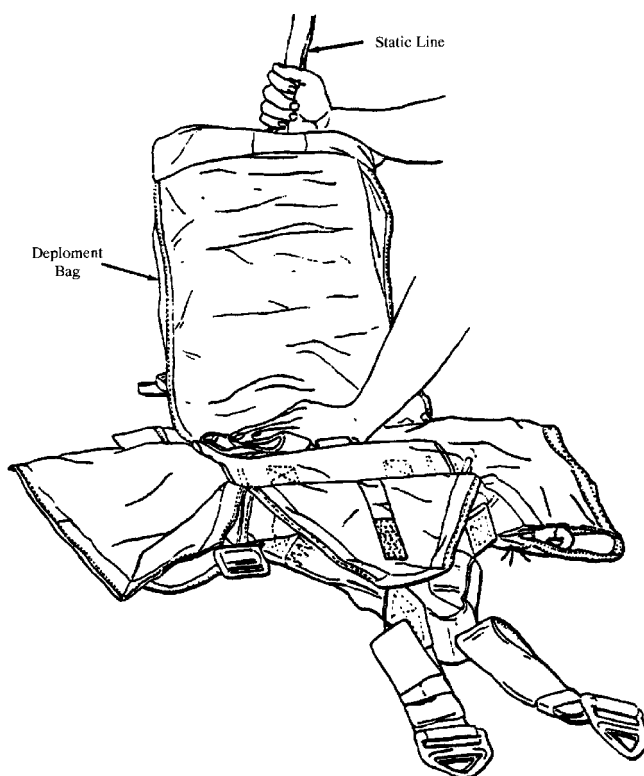

4. Remove twists from the static line and fold the static line across the deployment bag so that the pack-opening loop is up and in the center of the bag. Fold the remaining sleeve portion of the static line under the upper end of the deployment bag.

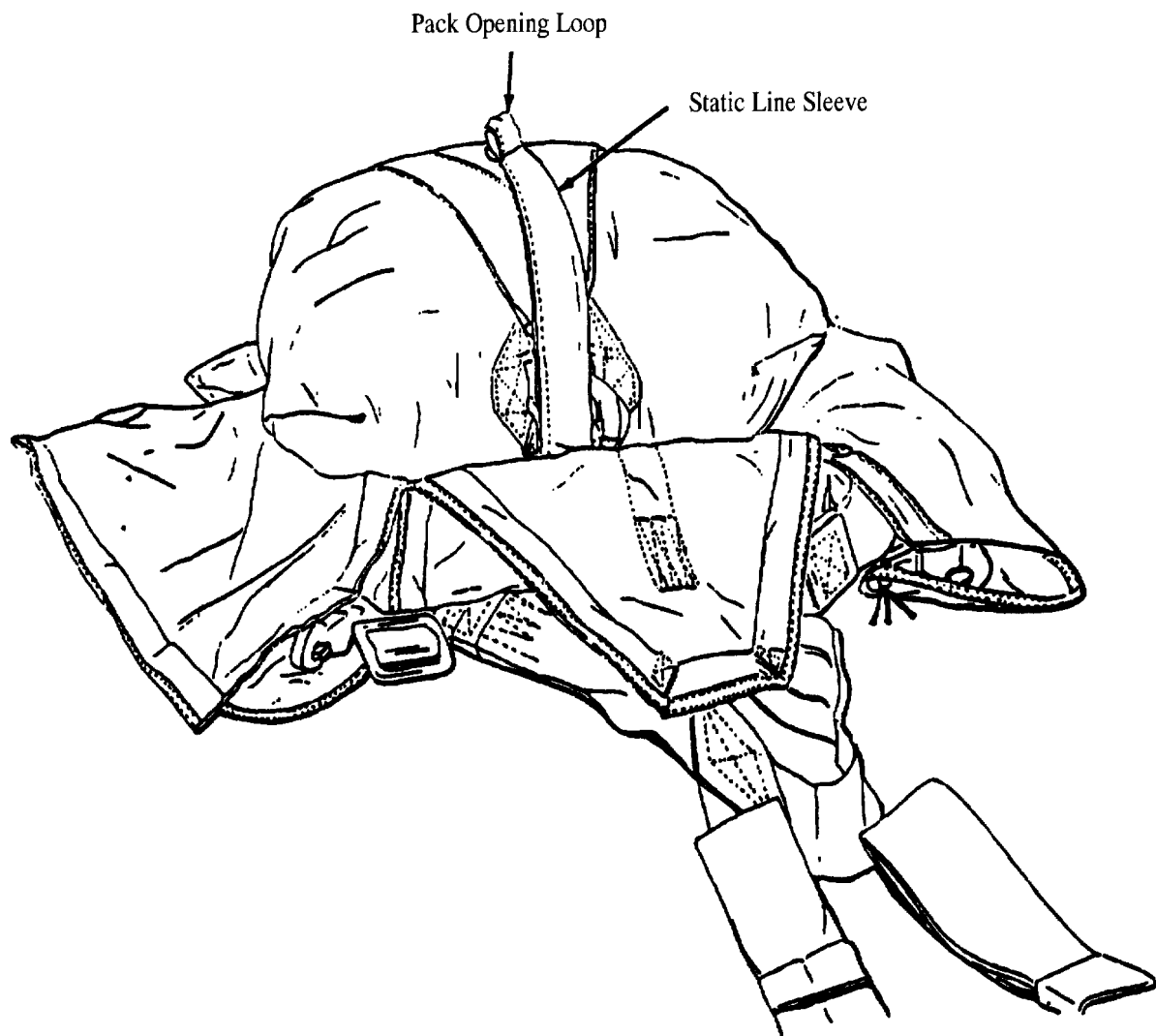

NOTE

Be sure that none of the webbing passes over the static line.

5. Lay the pack-closing flaps over the deployment bag. Thread a 40-inch length of type I, 1/4-inch, cotton webbing through the lower end flap closing loop, the static line pack opening loop, the left side flap closing loop, the upper end flap closing loop, under the static line, and through the right side flap closing loop.

NOTE

Be sure that none of the webbing passes over the static line.

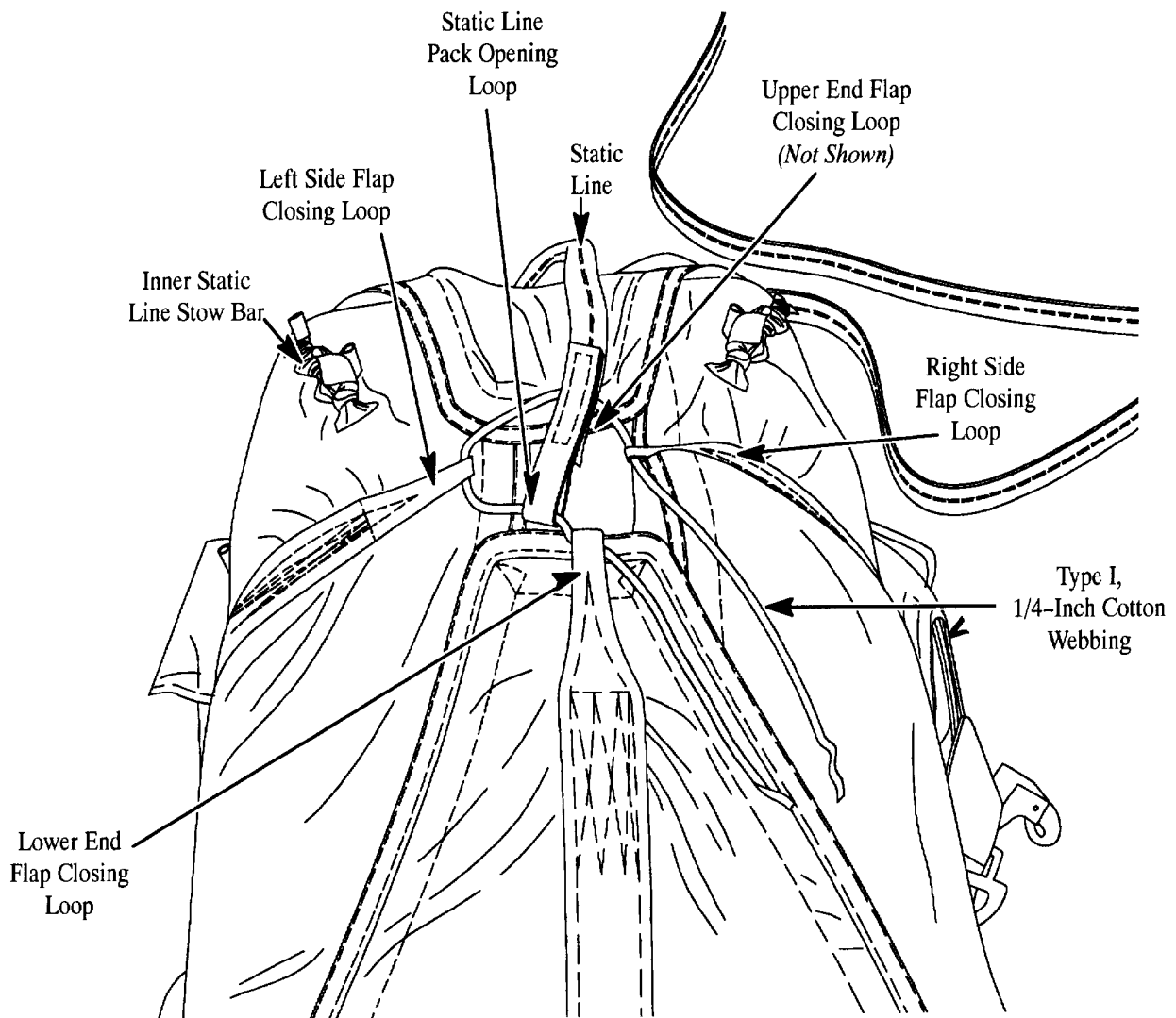

6. Pull the loops close enough together to have an opening, of approximately 2-inches in diameter, between loops. Tie the webbing with a surgeon's knot and a locking knot, making a tie between the right side flap and the lower end flap closing loops. Cut the webbing approximately 2-inches from the knot. Keep the remaining lengths for the next connector link's ties.

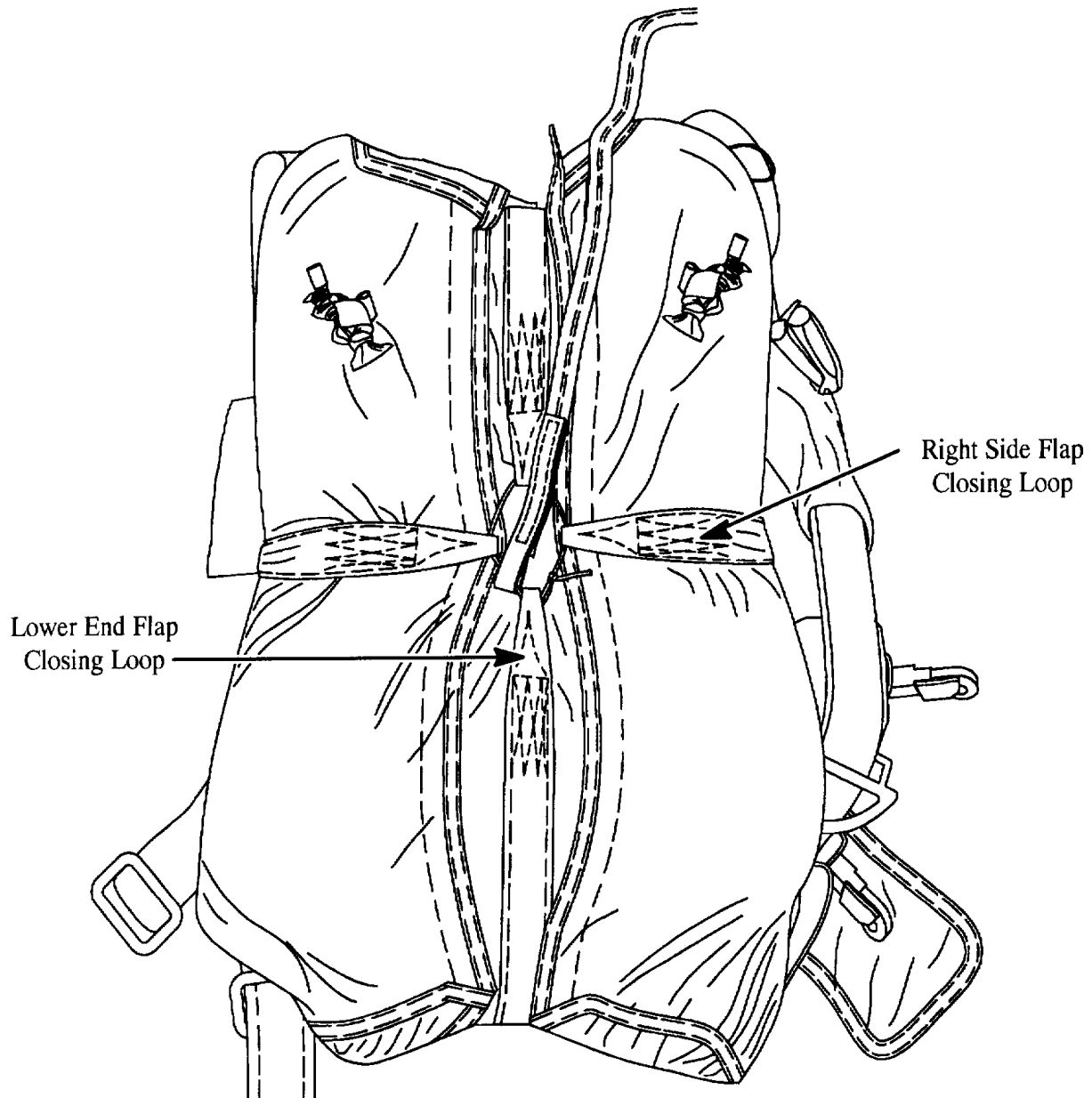

-
7. Using a packing paddle, insert flaps and dress the pack. The pack tray is now closed.

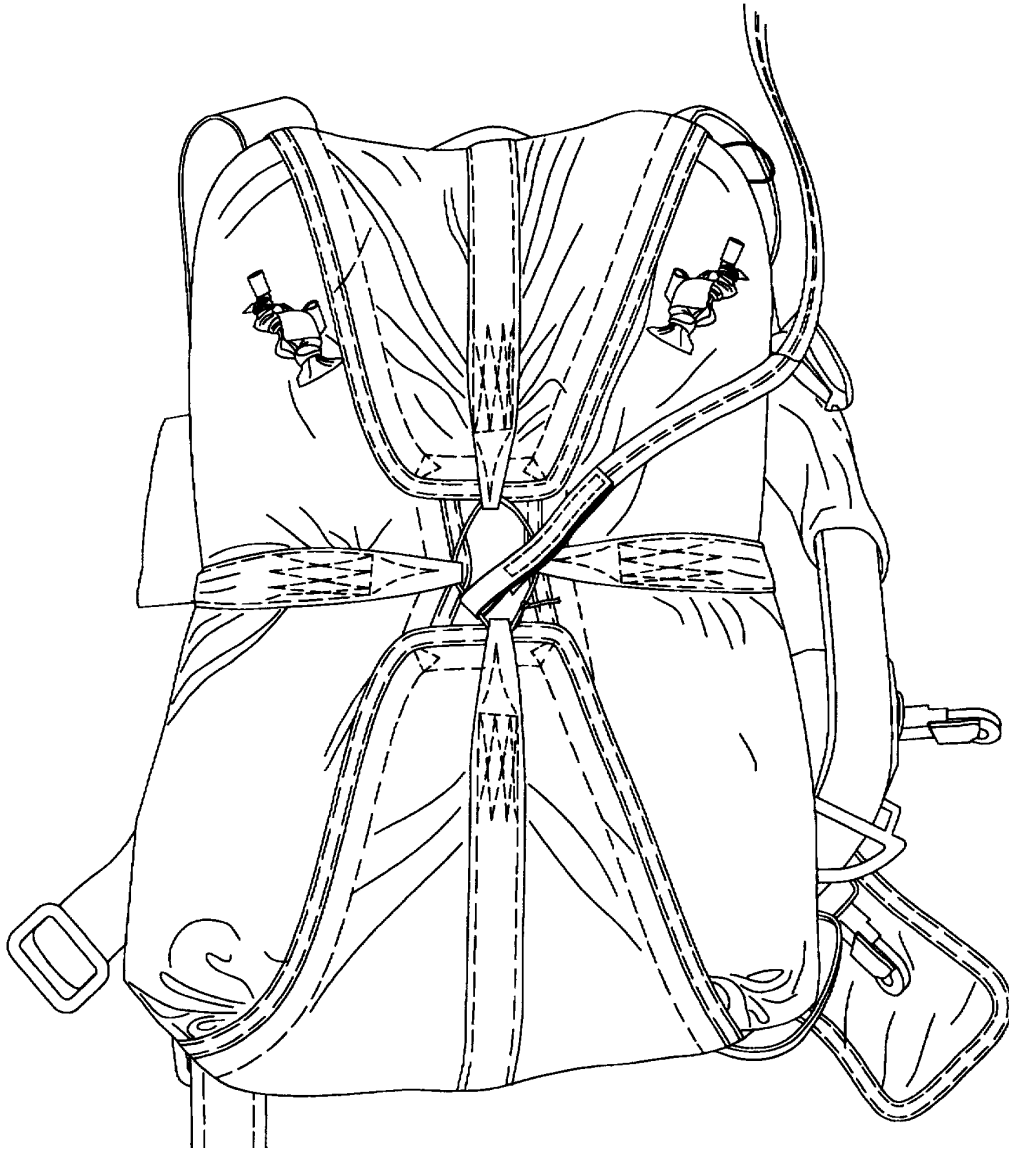

8. Rigger check number 6.

STOWING THE STATIC LINE

After the pack tray is dressed, stow the static line as follows:

1. *Stowing the standard 15-foot static line.*

NOTE

Install the necessary number of rubber bands, on the left and right outer and inner static line retainer band keepers, with a girth hitch. Static line stows are secured with two-turns of a rubber band. The end of each stow must not be longer than 2-inches from the rubber band. Ensure static line is not twisted.

- a. Rotate the pack tray a quarter-turn counterclockwise. Make the first static line stow to the lower right outer stow bar. Make the second static line stow to the lower left outer stow bar. Make the third static line stow to the lower right inner stow bar. Make the fourth static line stow to the lower left inner stow bar. Make the fifth static line stow to the middle right inner stow bar. Make the sixth static line stow to the middle left inner stow bar. Make the seventh static line stow to the upper right inner stow bar. Make the eighth static line stow to the upper left inner stow bar.

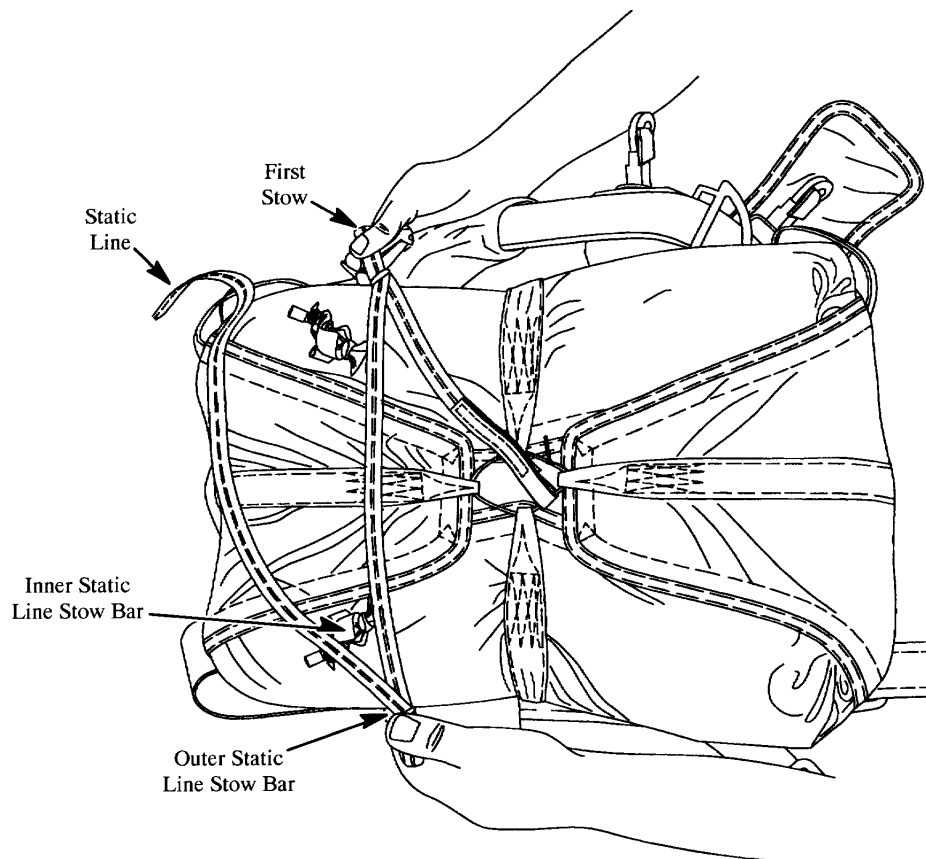

- b. Fold remaining static line in half, and rotate it a quarter-turn counterclockwise. Pass the folded end through the static line slack retainer. After hooking the static line snap hook to the static line pack opening loop, pass the folded end under the stowed line. Pull the static line taut, and slip the folded end of the line under the lower end flap.

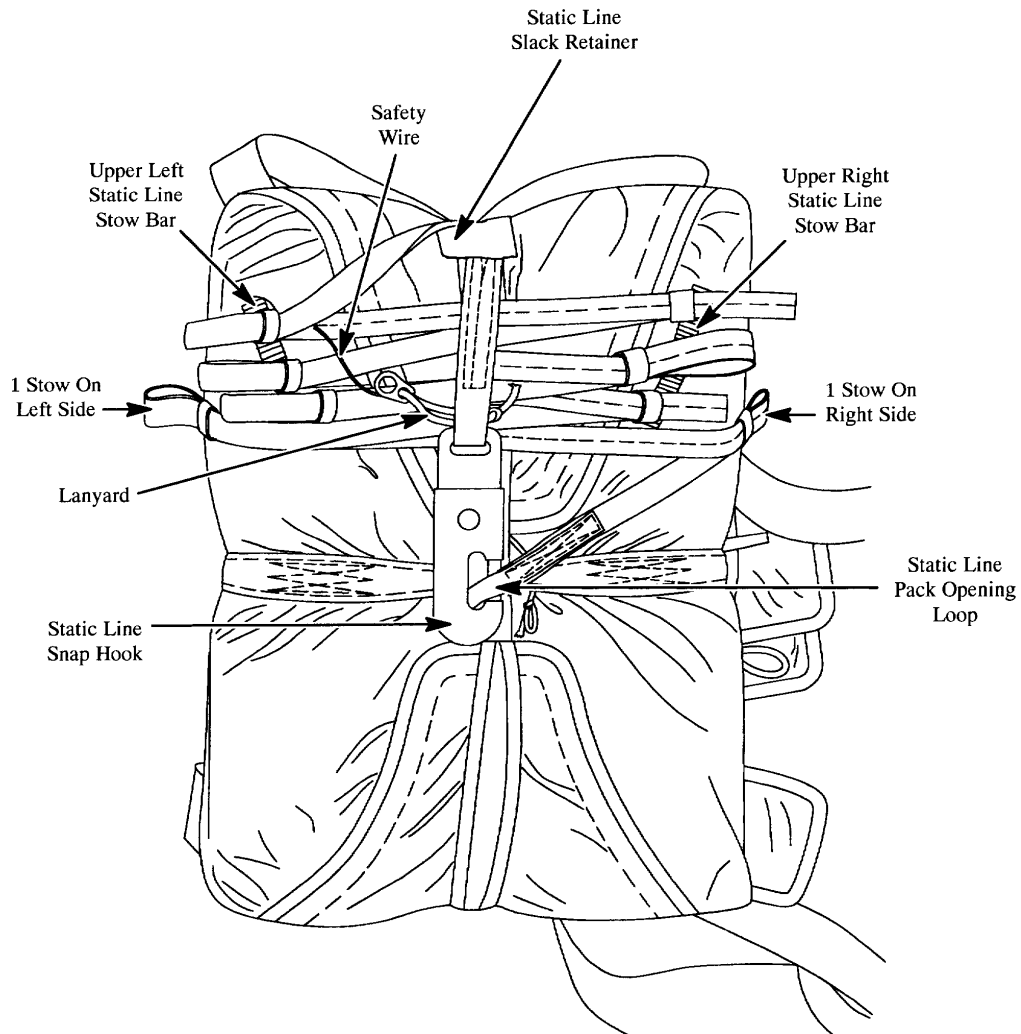

NOTE

The following is an alternate method for completing the static line stow.

- c. After making the static line stows described in step a., above, stow the running end of the static line as follows:

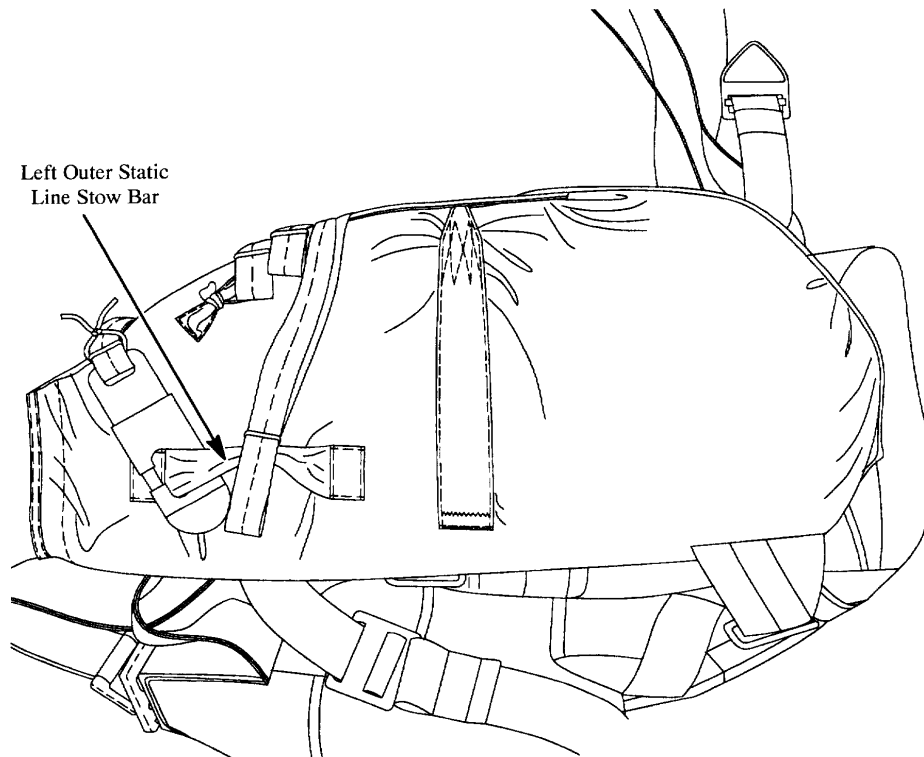

- (1) Double the remaining static line length and rotate the doubled length one-quarter turn counterclockwise.
- (2) Connect the static line snap hook to the left-side retainer band keeper.
- (3) Pass the folded end of the static line through the static line slack retainer (at the pack upper end), under the stowed line (toward the pack lower end), and draw the doubled line taut.
- (4) Insert the static line folded-end under the pack lower-end flap.

2. *Stowing the USL.*

NOTE

Install the necessary number of rubber bands, on the left and right outer and inner static line retainer band keepers, with a girth hitch. Static line stows are secured with two turns of a rubber band. The end of each stow must not be longer than 2-inches from the rubber band. Ensure static line is not twisted.

- a. Rotate the pack tray a quarter-turn counterclockwise. Make the first static line stow to the lower right outer stow bar. Make the second static line stow to the lower left outer stow bar. Make the third static line stow to the lower right inner stow bar. Make the fourth static line stow to the lower left inner stow bar. Make the fifth static line stow to the middle right inner stow bar. Make the sixth static line stow to the middle left inner stow bar. Make the seventh static line stow to the upper right inner stow bar. Make the eighth static line stow to the upper left inner stow bar.
- b. Secure the snap hook to the upper right outer stow bar. Stow the remaining static line in the static line slack retainer. Stow the excess under the existing stows and the bottom of the pack tray protector flap.

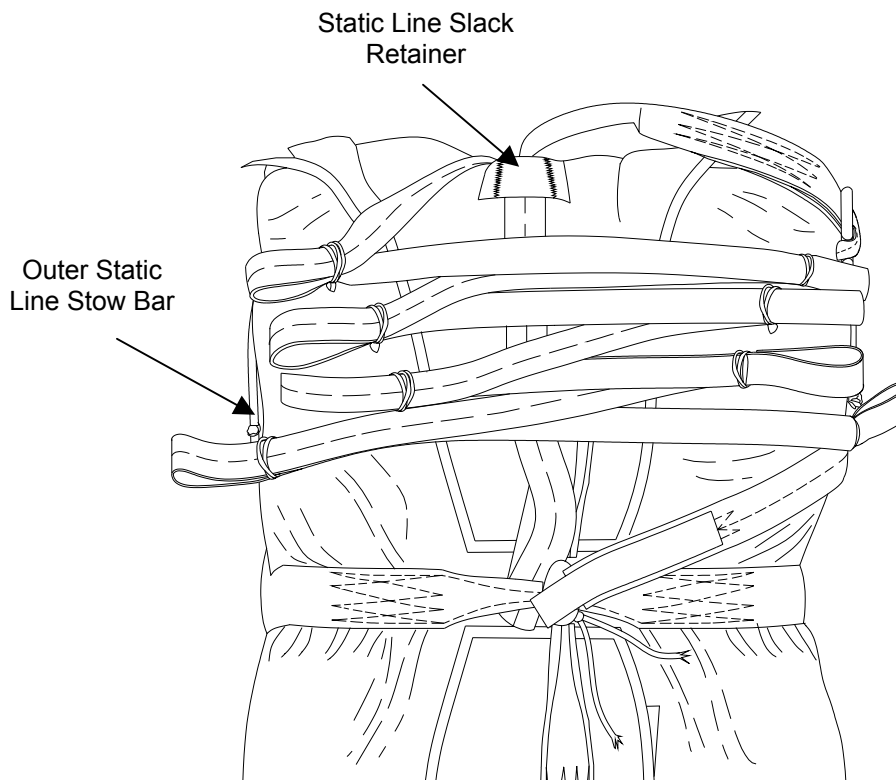

3. Stowing the USL and USL extension.

NOTE

The girth hitch, attaching the USL extension to the USL must be centered between the ninth and tenth stows. If necessary, adjust the previous stows. The end of each stow must not be longer than 2-inches from the rubber band.

- a. Rotate the pack tray a quarter-turn counterclockwise. Make the first static line stow to the lower right outer stow bar. Make the second static line stow to the lower left outer stow bar. Make the third static line stow to the lower right outer stow bar. Make the fourth static line stow to the lower left outer stow bar. Make the fifth static line stow to the lower right inner stow bar. Make the sixth static line stow to the lower left inner stow bar. Make the seventh static line stow to the middle right inner stow bar. Make the eighth static line stow to the middle left inner stow bar. Make the ninth static line stow to the upper right inner stow bar. Make the tenth static line stow to the upper left inner stow bar.
- b. Secure the snap hook to the upper right outer stow bar. Stow the remaining static line in the static line slack retainer. Stow the excess under the existing stows and the bottom pack tray protector flap.

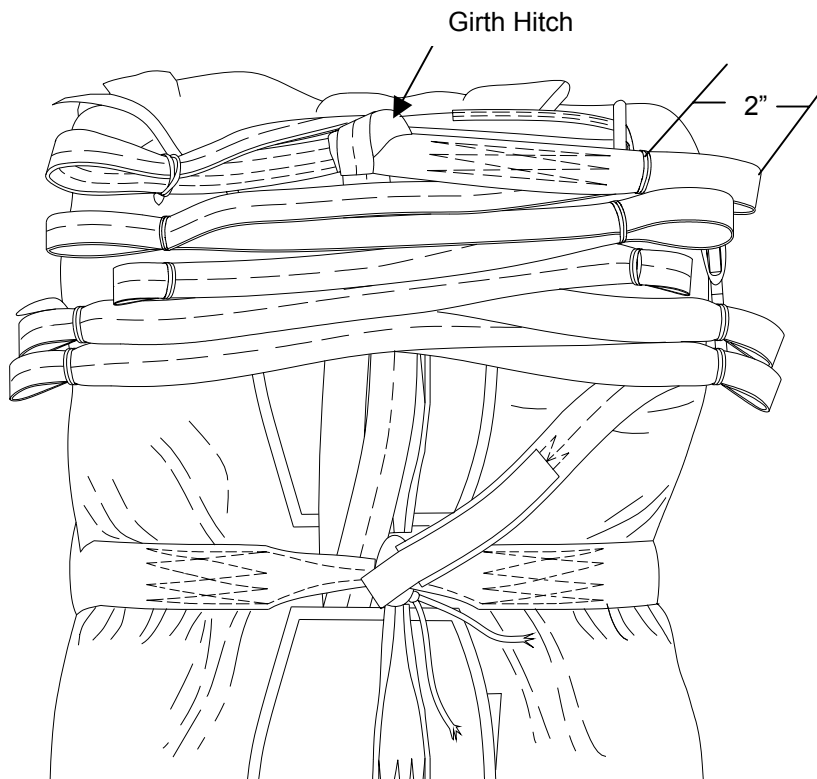

4. Rigger check number 7.

ARMY PARACHUTE LOG RECORD

Beginning with the initial packing of a parachute, and each time a parachute is repacked, the log record must be completed, as follows:

1. Remove the log record (DA Form 3912, AFTO 391, and NAVWPNCEN or NAVWPNS CL 13512/11) from the parachute inspection data pocket (log record pocket) located on the riser.

2. Make entries on the JUMP, INSPECTION AND REPACK DATA page, as follows:

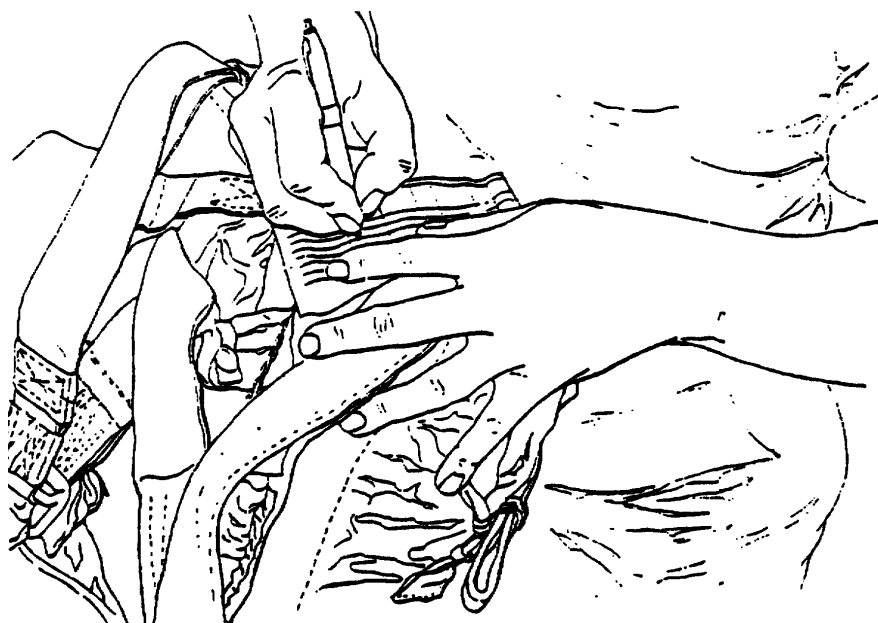

- a. *Date*. Enter the day, month and year of each packing action.
 - b. *Bag Number*. Entry made in the TYING CONNECTOR LINKS AND SUSPENSION LINE PROTECTIVE COVER paragraph, step 5., above.
 - c. *Routine inspection*. No entry required.
 - d. *Jumps or dropped*. No entry required.
 - e. *Repack*. For initial packing, enter IN; thereafter, enter a checkmark in the column each time the parachute is repacked.
 - f. *Packer's name*. The packer performing the packing will sign this entry.
 - g. *Inspector's name*. The inspector who has performed the pack-in-process inspection will sign this entry.
 - h. *Unit*. Enter the unit designation to which the packer and/or inspector is assigned.
3. Return the log record to the log record pocket upon completion of the entries. Packing is now completed.

STANDARD STATIC LINE EXTENSION

For units not using the USL, a standard 5-foot static line extension is required when jumping the CH-46 and CH-53 helicopters. The USL five-foot extension is required when jumping the C-17. The static line extensions will be attached and stowed as follows:

NOTE

For units authorized to jump the C-2A aircraft, a 10-foot static line extension is required. Manufacture IAW NAVSEA T.O. 300-AW-MM0-010.

1. *Attaching the standard 5-foot extension to a standard 15-foot static line.*
 - a. Attach the standard 5-foot extension to a 15-foot static line by attaching the snap hook on the static line to the ring on the extension. Insert and bend the safety pin.

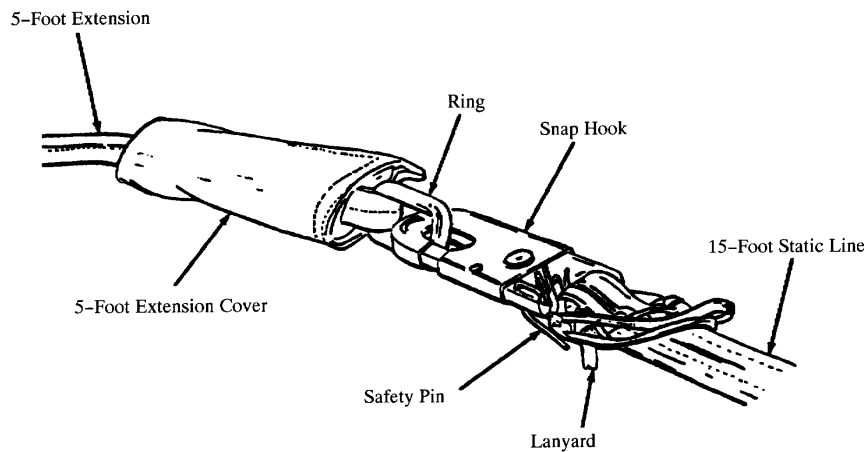

- b. Slide the cover that is permanently attached to the standard 5-foot extension, down over the snap hook of the standard 15-foot static line, and tie and tape in place using 2-inch wide masking tape.

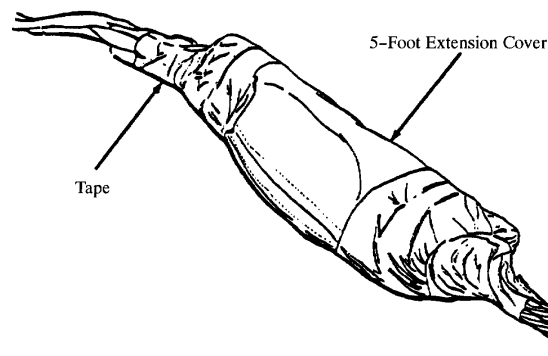

- c. Stow the standard static line (with standard 5-foot static line extension attached) in accordance with paragraph 3., Stowing the USL and USL Extension procedures detailed above.

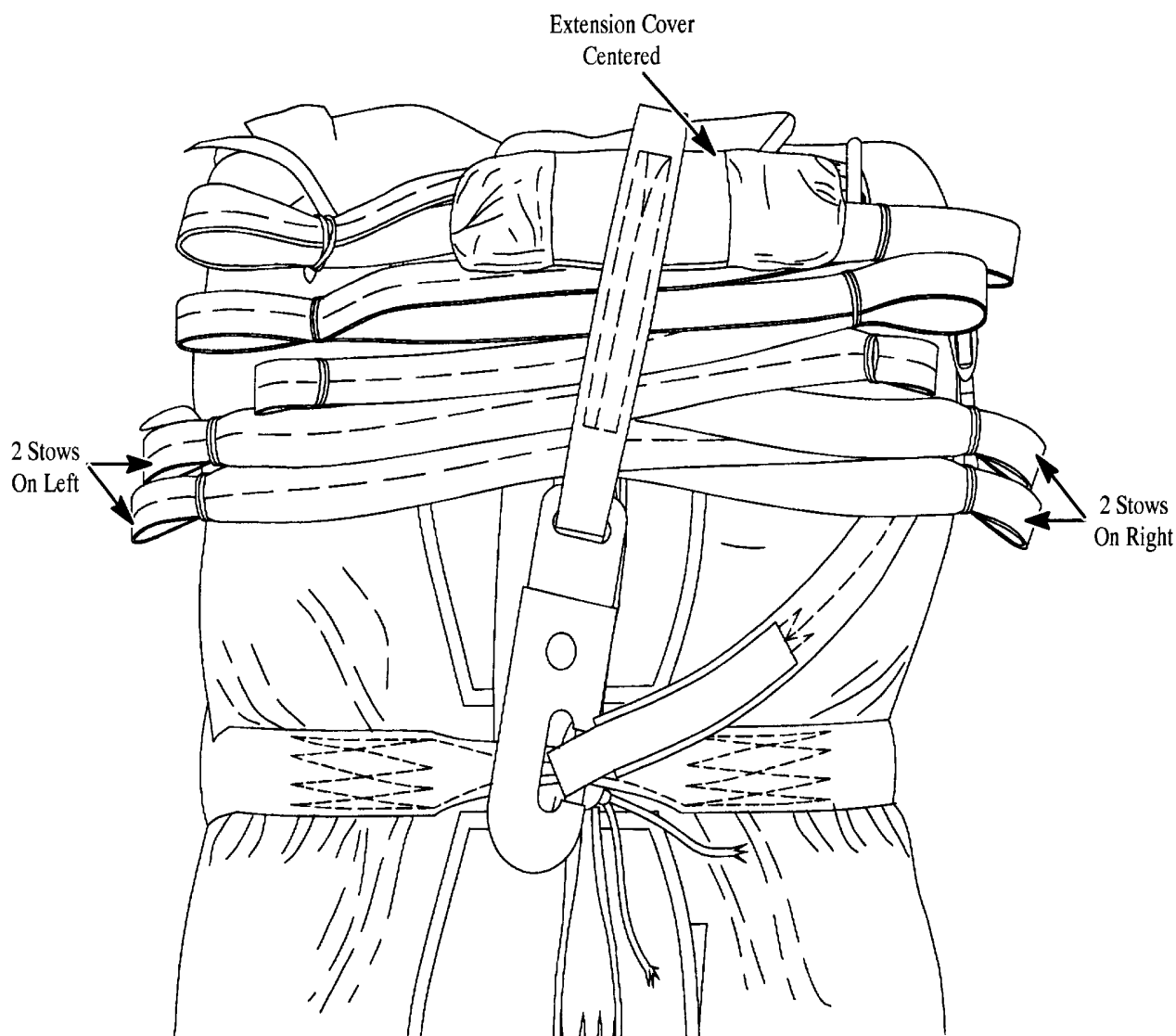

ATTACHING USL AND USL EXTENSION

1. *Attaching the USL extension to the USL.*
 - a. Take the parachute off, or perform the task while the jumper is wearing the parachute.
 - b. Unstow the static line.

- c. Remove the snap hook from the USL:
 - (1) Remove the snap hook by grasping the sewn portion of the static line, just below the snap hook.
 - (2) Push the static line towards the snap hook, this will allow you to loosen the girth hitch. Once you loosened the girth hitch, push the 3½ -inch loop up the sides of the snap hook. Then push the static line from the bottom to the top so that you can pass the 3½-inch loop over the top of the snap hook.
 - (3) Pull the static line back through the opening in the base of the snap hook.
- d. Attach the snap hook to the USL extension:
 - (1) Position the snap hook so the opening is facing outward; lay the static line flat; ensure the green ID marking thread is on top, also ensure the green ID marking thread is on the outside of the 3½-inch loop.
 - (2) Pass the 3½-inch loop end of the static line through the opening in the base of the snap hook, from the bottom to the top. Pass the top of the snap hook through the static line loop.
 - (3) Continue passing the snap hook through the static line loop; pull the excess static line back through the opening in the base of the snap hook until the loop is past the snap hook opening. Turn the 3½-inch loop outward so the green ID marking thread is now on the inside.
 - (4) Slide the loop down to the bottom of the snap hook until the static line is fully seated in the indents on the side of the snap hook, forming a taut girth-hitch. Ensure there is no twists in the static line snap hook loop.
- e. Attach the USL extension to the USL:
 - (1) Pass the 3½-inch loop on the USL through the 2-inch buffer loop on the USL.
 - (2) Pass the snap hook of the USL extension through the 3½-inch loop on the USL.
 - (3) Continue passing the snap hook through the 3½-inch loop until a taut girth hitch is made securing the USL extension to the USL. There will be a half-twist in the 3½-inch loop when forming the girth-hitch.

2. *Stowing the USL and USL extension.* Stow the USL and USL extension in accordance with paragraph 3, STOWING THE USL AND USL EXTENSION procedures detailed above.

3. *Removing the USL extension from the USL:*

- a. Take the parachute off, or perform the task while the jumper is wearing the parachute.
- b. Unstow the static line.
- c. Remove the snap hook from the USL extension:
 - (1) Remove the snap hook by grasping the sewn portion of the static line just below the snap hook.
 - (2) Push the static line towards the snap hook, this will allow you to loosen the girth-hitch. Once you have loosened the girth-hitch, push the 3½-inch loop up the sides of the snap hook. Then push the static line from the bottom to the top so that you can pass the 3½-inch loop over the

-
- (3) top of the snap hook.
 - (4) Pull the static line back through the opening in the base of the snap hook.
- d. Remove the USL extension:
- (1) Secure the USL extension in your right hand and grasp the USL with your left hand.
 - (2) With the left hand push the USL towards the USL extension. Once the girth-hitch is loosened, pull the webbing of the USL extension through the 3½-inch loop on the USL until it is removed from the USL.
 - (3) Slide the 2-inch buffer loop over the top of the USL.
- e. Attach the snap hook to the USL:
- (1) Position the snap hook so the opening is facing outward; lay the static line flat; ensure the green ID marking thread is on top, also ensure the green ID marking thread is on the outside of the 3 ½-inch loop.
 - (2) Pass the 3½-inch loop end of the static line through the opening in the base of the snap hook, from the bottom to the top. Pass the top of the snap hook through the static line loop.
 - (3) Continue passing the snap hook through the static line loop; pull the excess static line back through the opening in the base of the snap hook until the loop is past the snap hook opening.
 - (4) Turn the 3½-inch loop outward so the green ID marking thread is now on the inside.
 - (5) Slide the loop down to the bottom of the snap hook until the static line is fully seated in the indents on the side of the snap hook, forming a taut girth-hitch. Ensure there is no twists in the static line snap hook loop.
4. Stow the USL. Stow the USL in accordance with paragraph 2., STOWING THE USL paragraph detailed above.

FOLDING THE HARNESS

For easier handling of the MC1-1C/MC1-1D parachute, after packing is completed, fold the harness as follows:

1. Turn the pack over and place the kit bag on top of the pack tray; attach the chest-strap quick-ejector snap to the adjusting V-ring.

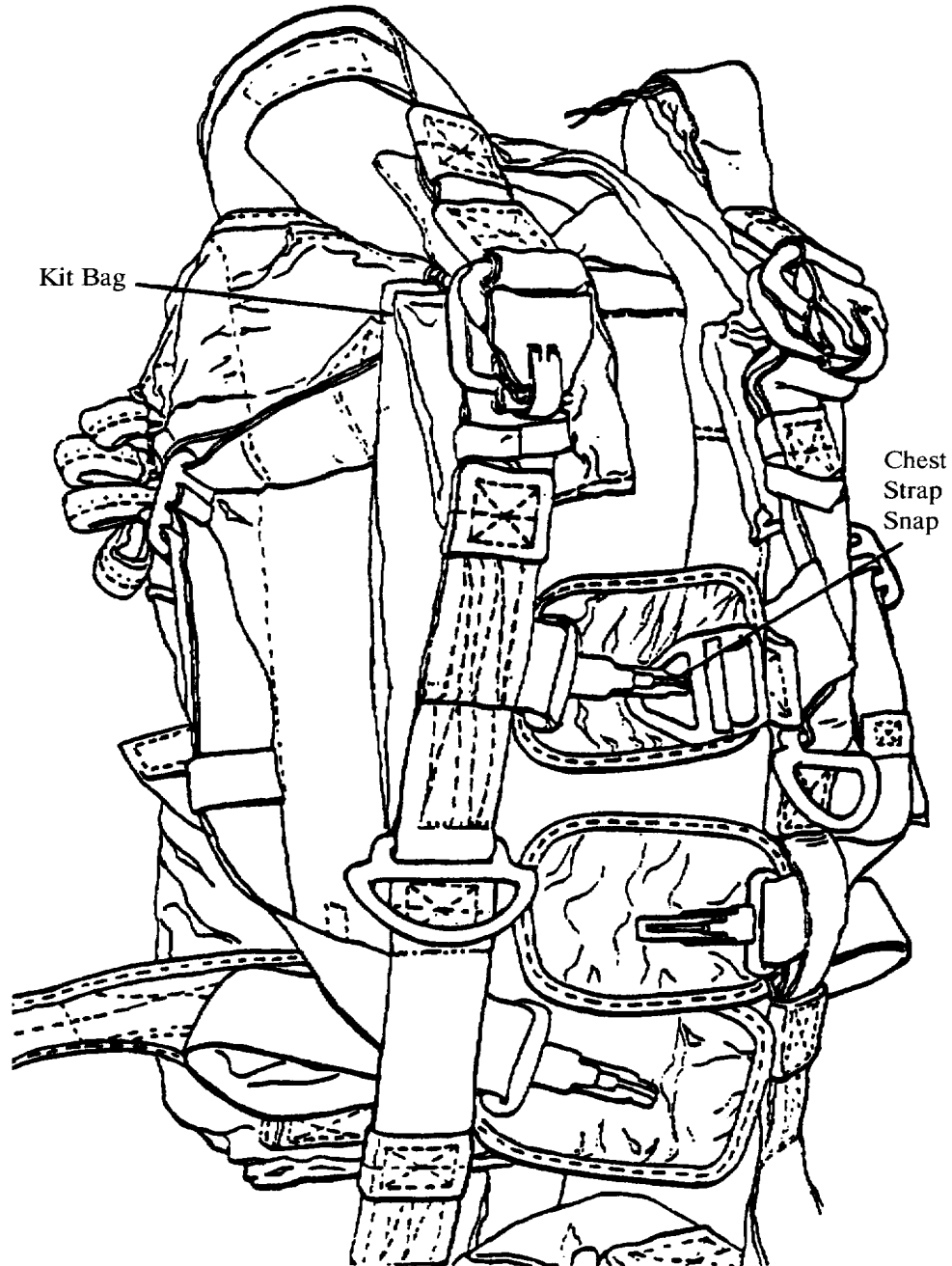

2. Pull the leg-strap through the kit bag carrying handle, under the diagonal back-straps; criss-cross the leg straps, and attach the quick-ejector snap to the adjusting V-ring.

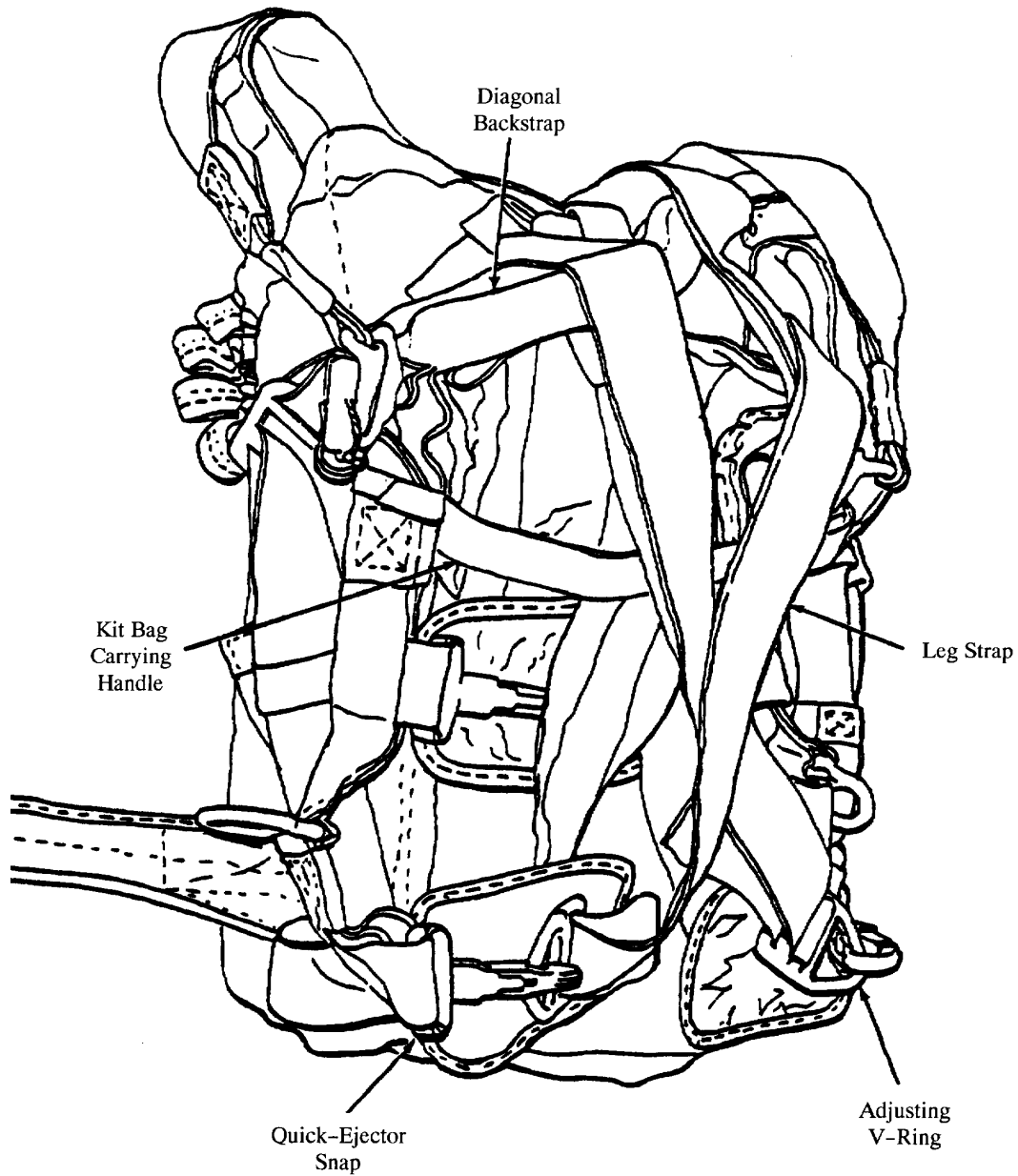

3. Grasp the saddle and pull straight up. Take the waistband through the saddle and completely around the harness located under the kit bag (pull tightly). Thread the waistband back through the saddle, into the waistband adjuster, and then back through the waistband adjuster, forming a quick-release.

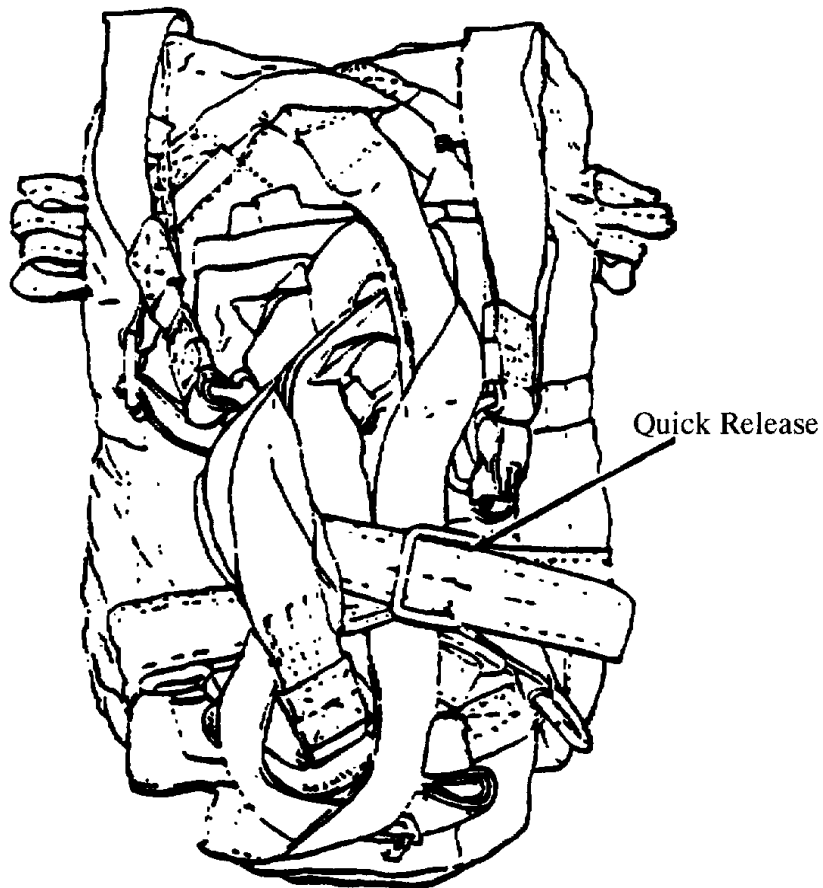

END OF WORK PACKAGE

THIS PAGE INTENTIONALLY LEFT BLANK

UNIT MAINTENANCE
MC1-1C/MC1-1D TROOP BACK PARACHUTE ASSEMBLY
SEWING PROCEDURES

THIS TASK COVERS:

- Basting and Temporary Tacking
 - Stitching and Restitching
 - Darning
 - Zig-Zag Sewing
 - Patching
-

INITIAL SETUP:**Equipment Condition**

Unpacked. Canopy with defects recorded.
 Clean.

Personnel Required

92R(10) Parachute Rigger

Tools

Specified in paragraph applicable to the item
 being repaired.

Materials/ Parts

Specified in paragraph applicable to the item
 being repaired.

References

WP 0014 00

NOTE

Sewing requirements will vary according to the type of item being repaired and the type of repair being made. The type of sewing machine, type of thread, the stitch range, and the stitch pattern (if applicable) required to accomplish a sewing procedure will be specified in the paragraph applicable to the item being repaired. All original stitching that is cut during the performance of a sewing procedure will be removed from the applicable item. Immediately after the accomplishment of a machine sewing procedure, trim thread ends to a point as close as possible to the material that has been sewn.

NOTE

Repair and replacement of parachute components is performed in accordance with the repair instruction in this section and in specific paragraphs applicable to the item being repaired. Fabrication is a means of replacing an air delivery item component that is damaged beyond repair and not an issue item. Though the act of fabrication is a replacement-type action, the function is actually a method of repairing an end item. Since most fabrication pertains to components that are peculiar to parachutes, the fabrication of components that are most general in nature will be detailed in the following paragraphs.

BASTING AND TEMPORARY TACKING

Basting and temporary tacking are hand-sewing methods used to temporarily hold layers of cloth fabric together while a repair is being performed. The following is a list of procedures that apply to basting and temporary tacking actions:

1. Basting and temporary tacking should be made using thread that is of a contrasting color to the material being worked.
2. Basting and temporary tacking will be performed using a single strand of size A, nylon thread, or ticket No. 24/4 cotton thread.
3. When basting, do not tie knots at any point in the thread length. Also, the sewing should be made with two stitches per inch.
4. Immediately upon completion of a repair, remove previously made basting or temporary tacking.

STITCHING AND RESTITCHING

Perform stitching and restitching as follows, refer to Tables 1 and 2.

1. *Parachute canopy assemblies.* The stitching and restitching made on parachute canopies should be accomplished with thread that is contrasting in color to the fabric being restitched. If contrasting color thread is not available, thread of matching color may be used, providing all other specifications are met. Straight stitching and restitching on parachute canopy assemblies should be locked by at least 2-inches at each end of a stitch row, when possible. Zig-Zag stitching does not require locking; however, zig-zag restitching should extend at least ¼-inch into undamaged stitching at each end, when possible. When restitching parachute canopy assemblies, stitch directly over the original stitching and follow the original stitch pattern as closely as possible.

Table 1. Sewing Machine Code Symbols.

| CODE SYMBOL | SEWING MACHINE |
|--------------------|--|
| LD | SEWING MACHINE, INDUSTRIAL: General Sewing; 301 Stitch; Light Duty; NSN 350-01-177-8590. |
| MD ZZ | SEWING MACHINE, INDUSTRIAL: Zig-Zag; 308 Stitch; Medium Duty; NSN 3530-01-181-1421. |
| LD ZZ | SEWING MACHINE, INDUSTRIAL: Zig-Zag; 308 Stitch; Light Duty; NSN 3530-01-181-1420. |
| HD | SEWING MACHINE, INDUSTRIAL: General Sewing; 301 Stitch; Heavy Duty; NSN 3530-01-177-8588. |
| MD | SEWING MACHINE, INDUSTRIAL: General Sewing; 301 Stitch; Medium Duty; NSN 3530-01-177-8591. |
| DN | SEWING MACHINE, INDUSTRIAL: Darning; Lock Stitch; NSN 3530-01-177-8589. |
| LHD | SEWING MACHINE, INDUSTRIAL: 301 Stitch; Light-Heavy Duty; NSN 3530-01-186-3079. |
| ND | SEWING MACHINE, INDUSTRIAL: 301 Stitch; Double-Needle; NSN 3530-01-182-2873. |

Table 2. Stitching and Restitching Specifications.

| COMPONENT | RECOMMENDED SEWING MACHINE (CODE SYMBOL) | STITCHES PER INCH | THREAD SIZE |
|--------------------------------|--|-------------------|-------------|
| Bridle Loop | LHD | 5 to 8 | 6 |
| Gore Section | LD DN LDZZ | 7 to 11 DARN | E |
| Pocket Band | LD | 7 to 11 | E |
| Suspension Line | MD ZZ | 7 to 11 | E |
| V-Tab | LD LD ZZ | 7 to 11 | E E |
| Control Line | LD ZZ | 7 to 11 | E |
| Vent Line | MD ZZ | 7 to 11 | E |
| Upper Lateral Band | MD ZZ | 7 to 11 | E |
| Lower Lateral Band | LD ZZ | 7 to 11 | E |
| Radial Seam | LD | 7 to 11 | E |
| Radial Tape | LD ZZ | 7 to 11 | E |
| Riser Assembly | LHD | 5 to 8 | 6 |
| Log Record Pocket | LD | 7 to 11 | E |
| Control Line Channel | MD ZZ | 7 to 11 | E |
| Guide Ring Retaining Strap | MD | 7 to 11 | E |
| Harness Assembly | | | |
| Elastic Slack Retainer Webbing | LD | 7 to 11 | E |
| Canopy Release Pad | MD | 7 to 11 | E |
| Ejector Snap Pad | MD | 7 to 11 | E |
| Horizontal/Diagonal Back-strap | LHD | 5 to 8 | 6 |
| Pack Tray | DN LD | Darn 7 to 11 | E or A E |
| Back-strap Keeper | LHD | 5 to 8 | 3 |
| Back-strap Retainer | LHD | 5 to 8 | 3 |
| Pack Closing Loop | LD | 7 to 11 | E |
| Retainer Band Keeper | LD | 7 to 11 | E |
| Static Line Slack Retainer | LD ZZ | 7 to 11 | E |
| Waistband | LHD | 5 to 8 | 3 |

Table 2. Stitching and Restitching Specifications - Continued.

| COMPONENT | RECOMMENDED SEWING MACHINE (CODE SYMBOL) | STITCHES PER INCH | THREAD SIZE |
|--|--|-------------------|-------------|
| Waistband Adjuster Panel | LHD LD | 5 to 8 7 to 11 | 3 E |
| Waistband Extension | MD | 7 to 11 | E |
| Deployment Bag | DN | Darn | E or A |
| Stow Loops | LHD | 5 to 8 | 3 |
| Edge Reinforcement Webbing | LD | 7 to 11 | E |
| Locking Stow Loop Hood | LD | 7 to 11 | E |
| Suspension Line Protector Cover Tie-Down Loop | LD | 7 to 11 | E |
| Static Line | LHD | 5 to 8 | 6 |

2. *Other parachute items.* Stitching and restitching on other parachute items constructed from cloth, canvas, and webbing should be accomplished with thread that matches the color of the original stitching, when possible. All straight stitching should be locked by backstitching at least ½-inch. Restitching should be locked by overstitching each end of the stitch formation by ½-inch. Zig-zag stitching does not require locking; however, zig-zag restitching should extend at least ¼-inch into undamaged stitching at each end, when possible. Restitching should be made directly over the original stitching; follow the original stitch pattern as closely as possible.

DARNING

(Refer to Tables 1 and 2). Darning is a sewing procedure used to repair limited size holes, rips, and tears. A darning repair may be made either by hand or by sewing machine, depending upon the method preferred and the availability of equipment. However, a darning machine should be used to darn small holes and tears where fabric is missing. A darning repair will be preformed using the following procedures, as appropriate:

1. *Machine darning.* Proceed as follows:
 - a. Using an authorized marking aid of contrasting color, mark a square around the damaged area and ensure the marking is at least ¼-inch back from each edge of the damaged area.
 - b. Darn the damaged area by sewing the material in a back and forth manner, using size A or E nylon thread.

- c. Turn the material and stitch back and forth across the stitching made in b., above, until the hole or tear is completely darned.

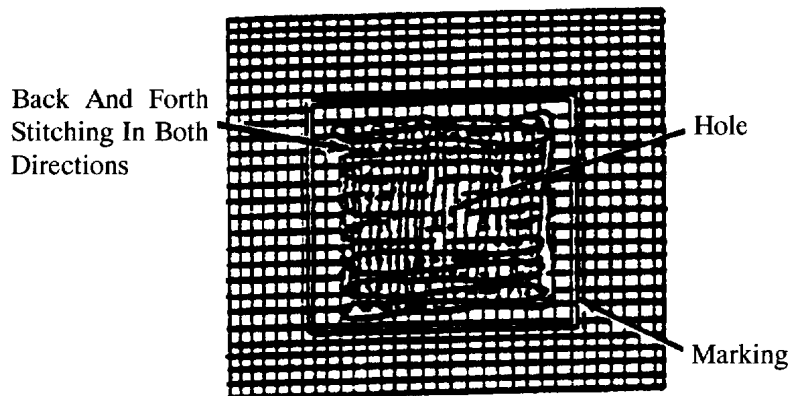

- d. If applicable, restencil informational data; gore number(s), or identification marks using the criteria in WP 0014 00.
2. *Hand darning.* When repair of a hole or tear is made by hand darning, the darn should match the original weave of the damaged material as closely as possible. Hand darning will be performed as follows:
- Using an authorized marking aid of contrasting color, mark a square around the damaged area and ensure the marking is at least $\frac{1}{4}$ -inch back from each edge of the damaged area.
 - Using a darning needle and a length of size A or E nylon thread, begin darning at one corner of the marked area. Working parallel with the marking, pass the needle and thread back and forth through the material until the opposite diagonal corner of the marked area is reached.

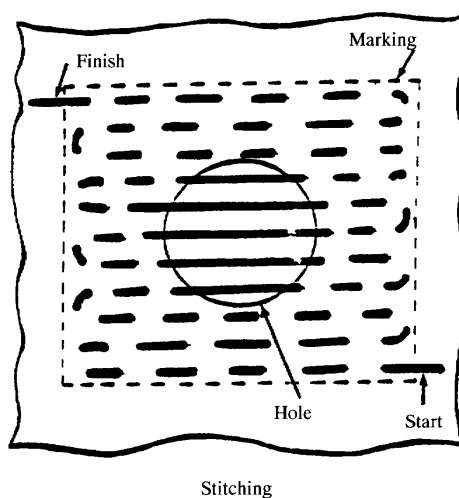

- c. Turn the material and weave the needle and thread back and forth across the stitching made in b., above, until the hole is completely darned.

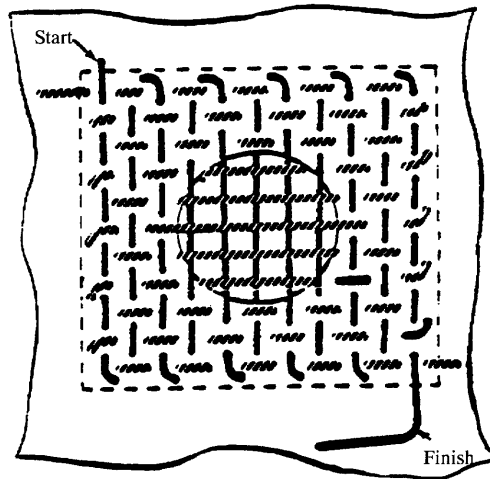

Hand Darning Completed

- d. If applicable, restencil informational data or identification marks as outlined in WP 0014 00.

ZIG-ZAG SEWING

(Refer to Tables 1 and 2). Components of the MC1-1C/MC1-1D, except the parachute canopy, that have sustained cut or tear damage, may be repaired by zig-zag sewing, provided the applicable damaged area does not have any material missing and the cut or tear is straight or L-shaped. Should the damaged area be irregular shaped or have material missing, the repair will be achieved by either darning or patching, as required. A zig-zag sewing repair will be accomplished using a zig-zag sewing machine, with the following procedures:

1. Set the sewing machine to the maximum stitch width.
2. Beginning at a point 1/4-inch beyond one end of the cut or tear, stitch lengthwise along the damaged area to a point 1/4-inch beyond the opposite end of the cut or tear.



Straight Cut Or Tear Stitching

3. The cited stitching procedure will also apply to an L-shaped cut or tear.

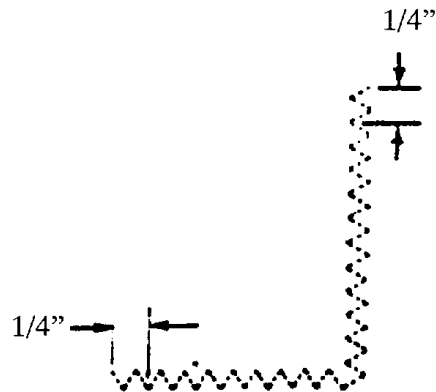

L-Shaped Cut Or Tear Stitching

4. If applicable, restencil informational data or identification marks as prescribed in WP 0014 00.

PATCHING

Patching is a procedure used to repair holes that cannot be darned.

1. *Parachute canopy patching limitations.* The following is a list of patching limitations for the MC1-1C/MC1-1D parachute assembly:

WARNING

The limitations prescribed for the parachute canopy patching will be stringently adhered to under all circumstances and without any deviations. Failure to do so may result in death or serious injury to personnel.

- a. A patch will not be applied to a damaged area that has been previously patched.
- b. There is no limitation to the number of patches, or size of patch, made to each canopy gore section or gore panel. However, determination should be made as to the most economical method to be used, i.e., two or more patches versus one large patch, or one large patch versus a section replacement. A patch applied to a parachute canopy may extend from radial seam to radial seam.
- c. Use no more than two mending cloth patches on a canopy section. Limit the size of the finished patch to 10-inches. Round the corners of the patches to 1-inch radius. Use size E nylon thread, and sew a row of 7 to 11 stitches per inch, $\frac{1}{16}$ -inch in from the outer edge of the patch. Table 3 prescribes sizes of parachute mending cloth.

Table 3. Mending Cloth Patching Specifications.

| DAMAGED AREA SIZE | PATCH MINIMUM SIZE |
|-----------------------|--------------------|
| 1-inch to 1½-inches | 2-inches |
| 1½-inches to 2-inches | 3½-inches |
| 2-inches to 3-inches | 4½-inches |
| 3-inches to 5-inches | 9-inches |
| 5-inches to 7-inches | *10-inches |

**Maximum size for a canopy patch is 10-inches.*

NOTE

The patch may be placed on top of the net when stitching the patch to the lower lateral band.

2. *Making a basic patch.* A basic patch is used to repair damaged cloth when the affected area is no closer than 1-inch from a radial seam or lower lateral band. Should a damaged area be closer than 1-inch to the cited areas, a miscellaneous patch will be made as detailed in paragraph 3., below. There are three methods that may be used to apply a basic patch; the procedures for performing each method are outline in paragraphs a. and b., as follows:

NOTE

A basic patch applied to the parachute canopy by sewing will be square or rectangular in shape. A parachute canopy basic patch, constructed from adhesive nylon parachute mending cloth, may be shaped rectangular or triangular, as required.

- a. *The sewn patch.* The primary method of applying a basic patch is by sewing. When using this method of patching on a parachute canopy, the patch will be applied to the inside of the canopy. The deployment bag may be patched on either the inside or the outside. (The sewn patch is shown on the following page).

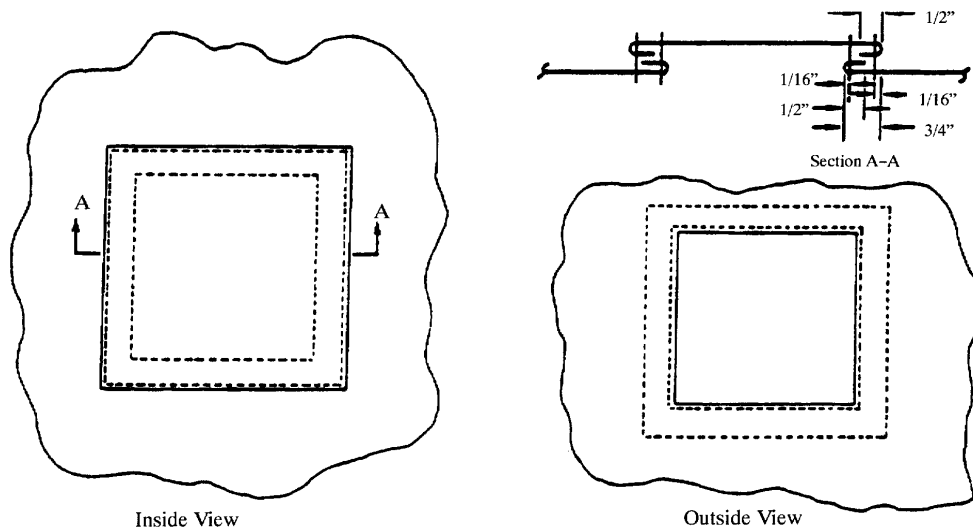

Apply a sewn patch as follows:

- (1) Place the repairable item on a repair table, smooth the fabric around the damaged area, and secure the item to the table with pushpins. Do not pin the damaged area.
- (2) Using an authorized marking aid of contrasting color, mark a square or rectangle around the area to be patched.
- (3) Cut the damaged fabric area along the lines made in 2., above. Further, cut the fabric diagonally at each corner to allow a ½-inch foldback in the raw edges.
- (4) Make a ½-inch foldback on each raw edge. Pin and baste each foldback to complete the prepared hole. Basting will be performed using the procedures in the BASTING AND TEMPORARY TACKING paragraph detailed above.
- (5) Using the same type of material as in the original construction, mark and cut a patch 2½-inches wider and longer than the inside measurements of the prepared hole.
- (6) Center the material over the prepared hole. Pin the patch material in position.
- (7) Make a ½-inch foldunder on each edge of the patch material, and baste the patch to the prepared area. Basting will be performed using the procedures in the BASTING AND TEMPORARY TACKING paragraph detailed above.
- (8) Remove the pushpins securing the canopy to the repair table; secure the patch by stitching, using the applicable details in the STITCHING AND RESTITCHING paragraph and figure detailed above. Make the first row of stitching completely around the patch. Turn the canopy over and make a second row of stitching around the prepared hole. Stitching will be performed in accordance with the STITCHING AND RESTITCHING paragraph detailed above.
- (9) If applicable, restencil informational data, or gore number, according to procedures in WP 0014 00.

- b. *The parachute mending cloth patch.* A second method of applying a basic patch is by use of 36-inch-wide adhesive, nylon, parachute mending cloth. Patch limitations as outlined in paragraph 1., above, shall be adhered to. Apply a parachute mending cloth patch as follows:

NOTE

Age life for the nylon parachute mending cloth, prior to application, is three years from the date of the adhesive coating, which is marked on each roll of mending cloth. Use no more than two mending cloth patches on a canopy section.

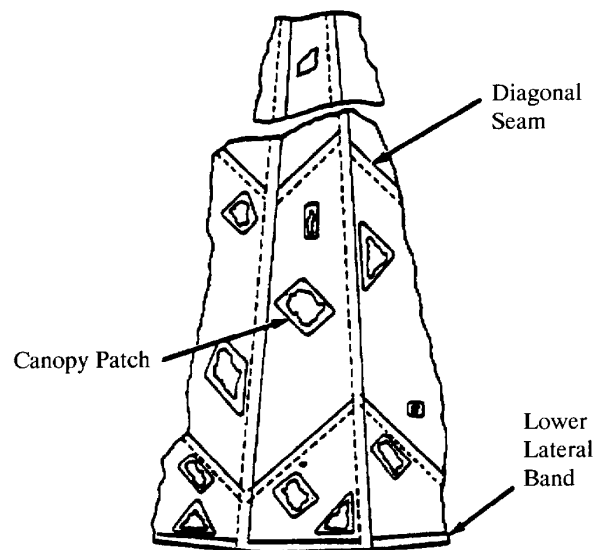

- (1) Lay out the canopy with the damaged area exposed.
- (2) To facilitate the application of the mending cloth patch, place a ½- by 20- by 20-inch smooth wooden board or similar smooth, hard-finished, rigid material (except paper board) under the damaged area.
- (3) Trim the ragged, frayed, or severely burned areas of the canopy cloth to provide a smooth area for patch application.
- (4) Using an authorized marking aid of contrasting color, mark a square, triangle, or rectangle, as applicable, around the damaged area.
- (5) Measure and cut lengths of the mending cloth to achieve the shape and size of the intended patch. Cut the patch to provide an overlap of the damaged area using the specifications in table 3. Round-off the corners of the patch. Patches will be prepared in duplicate to allow for application on the inside and outside of the canopy.

- (6) Remove the paper backing from the adhesive side of the mending cloth by forming a crease; score the paper with a fingernail, and peel the paper from the adhesive coating. Ensure the mending cloth is not damaged when scoring the paper backing.
 - (7) Smooth the canopy material adjacent to the damaged area on the canopy outside; place the formed mending cloth patch over the damaged area.
 - (8) Using the edge of a packing paddle (or a roller), apply pressure to smooth the patch on.
 - (9) Apply the duplicate-shaped patch to the damaged area on the inside of the canopy, using the procedures in steps 6. and 7., above. Stitch $\frac{1}{16}$ -inch in from the outer edge of the patch using details from Tables 1 and 2.
3. *Applying a miscellaneous canopy patch.* A miscellaneous canopy patch, which may be irregularly shaped, is used to repair damaged canopy material when the location of the damaged area requires the patch to extend into (or over) a seam, reinforcement, or lateral band. Ascertain the type of patch required for the canopy, using the details in illustrations (A through I) following the canopy patch procedures detailed below. Apply a miscellaneous patch to a gore section as follows:

NOTE

A canopy gore section that cannot be patched with a basic patch, as outlined in paragraph 2., above, will be patched with a miscellaneous patch.

NOTE

Adhesive nylon parachute mending cloth will not be used in the construction or application of a miscellaneous canopy patch.

- a. Place the canopy inside out on a repair table; smooth the fabric around the damaged area, and secure the damaged gore section to the table with pushpins. Do not pin the damaged area of the gore section.
- b. As required, cut the applicable stitching to remove or lay aside items that may interfere with the patching process.
- c. Using an authorized marking aid of contrasting color, mark a rectangle or triangle around the damaged area. Make the mark $\frac{1}{2}$ -inch from any adjacent seam, reinforcement, or lateral band.
- d. Prepare the damaged area by cutting along the marks made in c., above. Also make a diagonal cut at each corner of the formed hole to permit a foldback of each raw edge.
- e. To complete hole preparation, make a $\frac{1}{2}$ -inch foldback of each raw edge. Pin and baste each edge foldback; use the procedures in the BASTING AND TEMPORARY TACKING paragraph detailed above.
- f. Using the same type of material as in the original canopy construction, mark and cut a patch $2\frac{1}{2}$ -inches wider and longer than the inside measurements of the prepared hole.

- g. Center the patch material over the prepared hole. Pin the patch material in position.
- h. Make a ½-inch fold under on each edge of the patch material and baste the patch to the prepared area. Basting will be performed using the procedures in the BASTING AND TEMPORARY TACKING paragraph detailed above.
- i. Remove the pushpins securing the canopy to the repair table and secure the patch by stitching according to the details in the illustrations detailed below, and using the stitching specifics outlined in Tables 1 and 2.
- j. Make the first row of stitching completely around the edges of the patch. Turn the canopy right-side-out and make a second row of stitching around the edges of the prepared hole. Stitching will be performed in accordance with the STITCHING AND RESTITCHING paragraph detailed above.

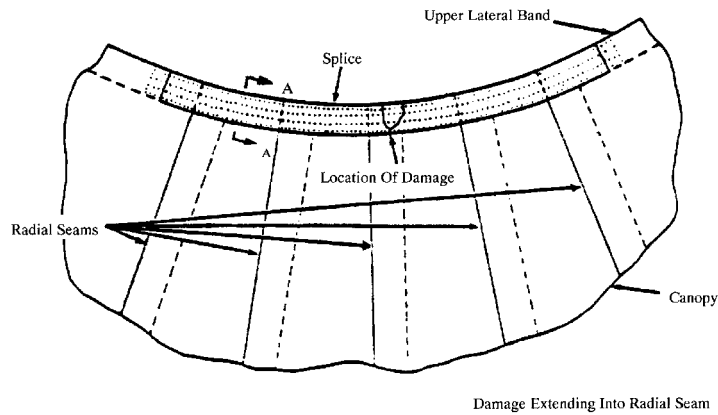
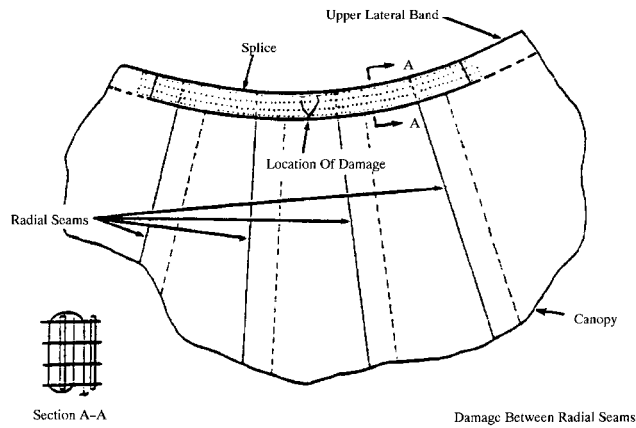

- k. Reposition the canopy items removed or laid aside in step b., above, in the original location and secure each item to the canopy by restitching according to original construction details and the STITCHING AND RESTITCHING paragraph detailed above.
- l. If applicable, restencil informational data or gore numbers according to procedures in WP 0014 00.

NOTE

If the outside of a diagonal seam is damaged, cut away the entire diagonal seam in the damaged area and patch as a basic patch.

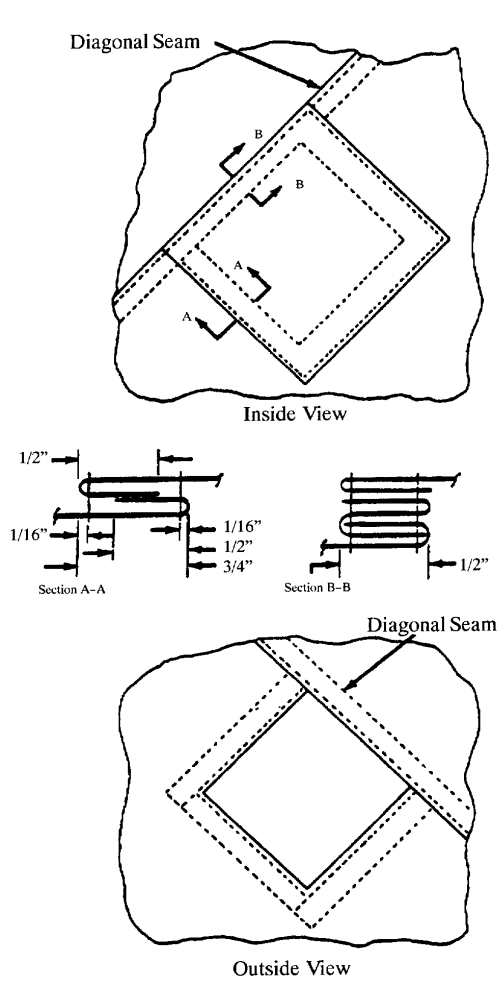

Ⓐ Rectangular Patch Including A Diagonal Seam

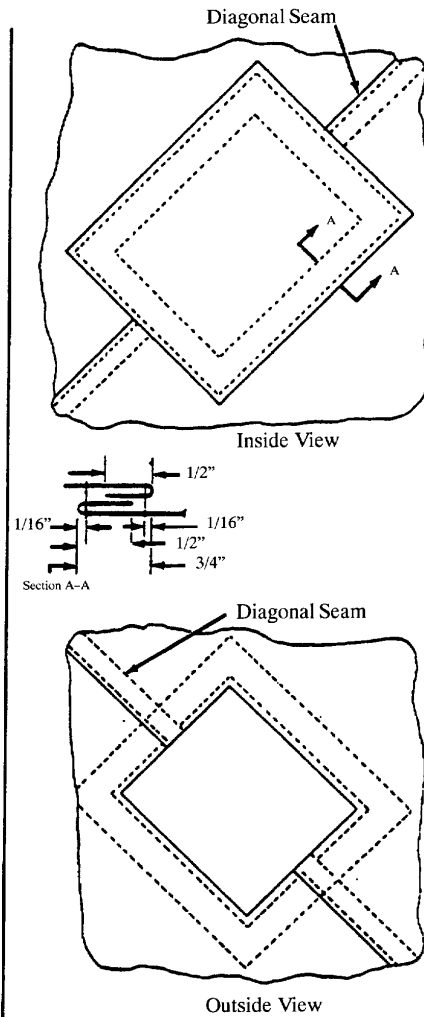

Ⓑ Rectangular Patch Crossing A Diagonal Seam

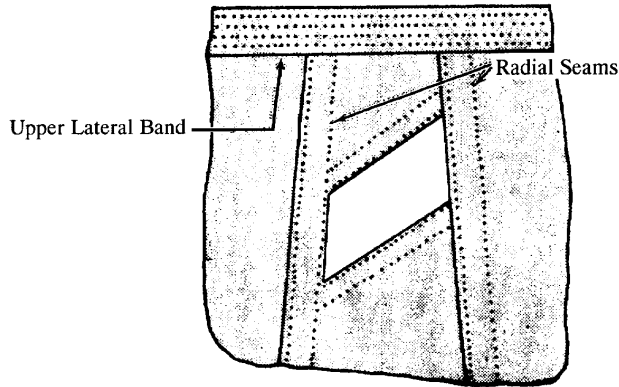
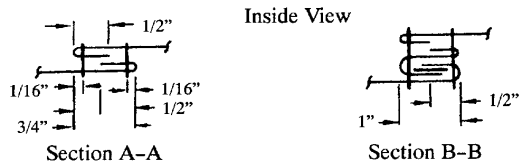
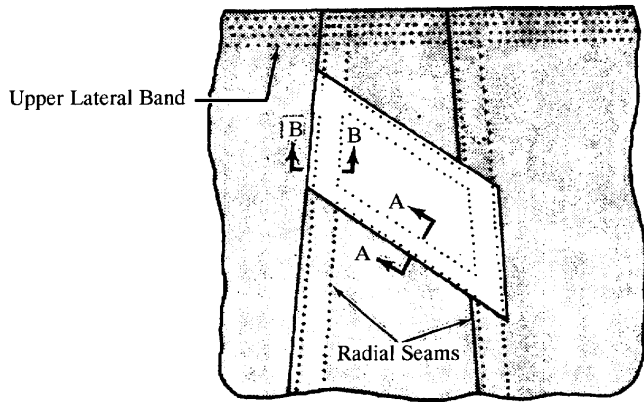

Outside View

Ⓒ Irregular Shape Patch Including Two Radial Seams, Continuous Line Canopy.

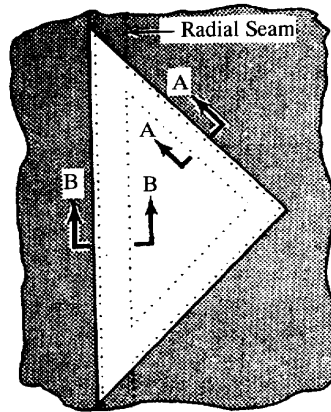

Inside View

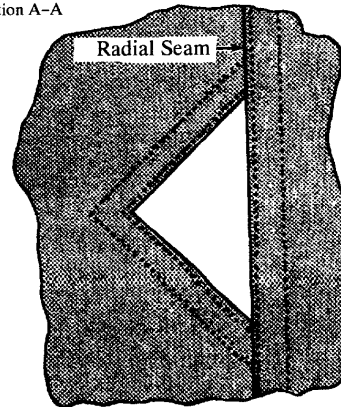
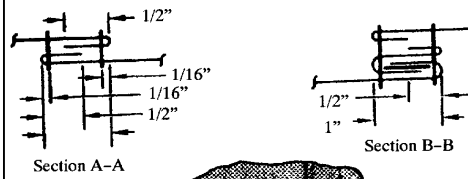

Outside View

Ⓓ Triangular Patch Including Radial Seam, Noncontinuous-line canopy.

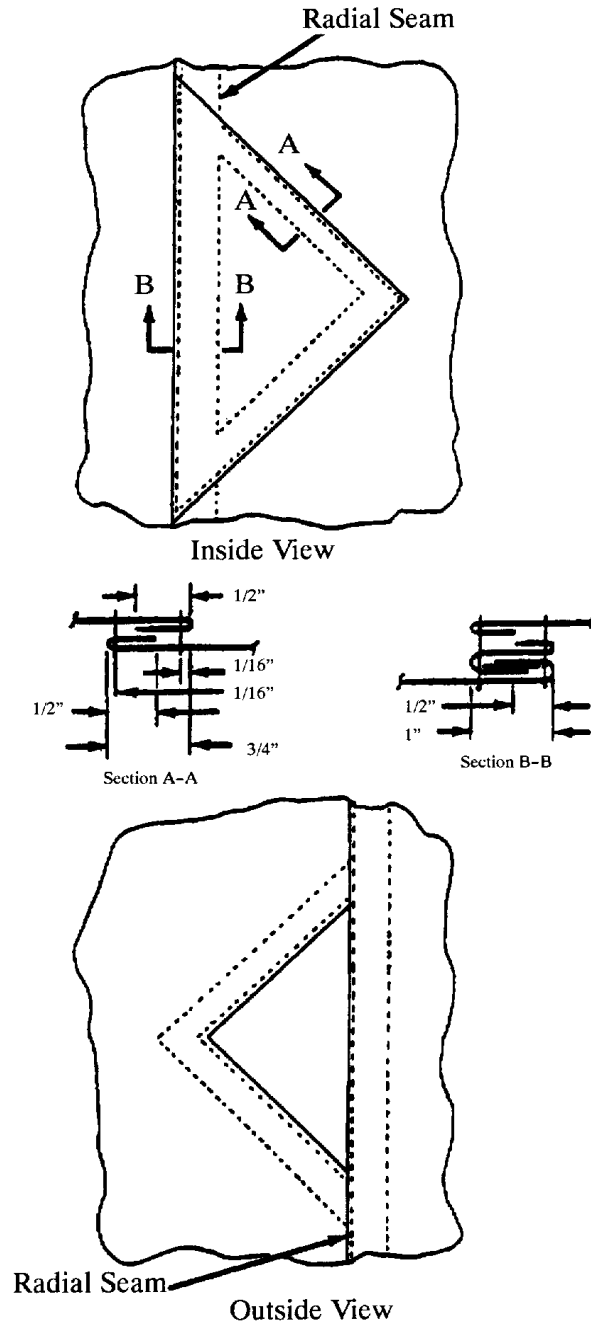

Ⓔ Triangular Patch Including Radial Seam

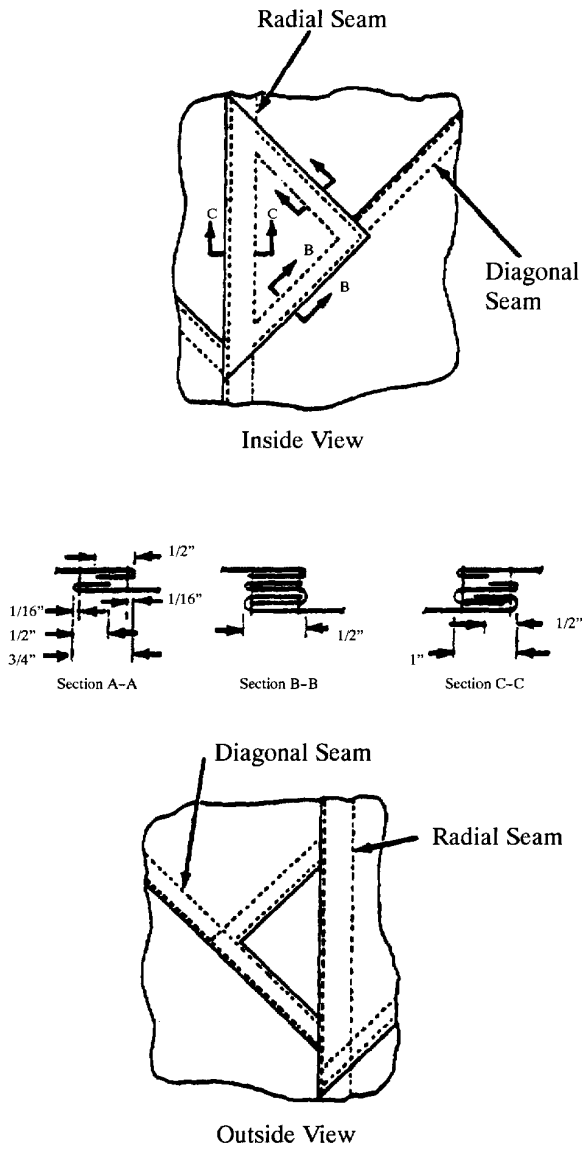

(F) Triangular Patch Including A Radial Seam And A Diagonal Seam

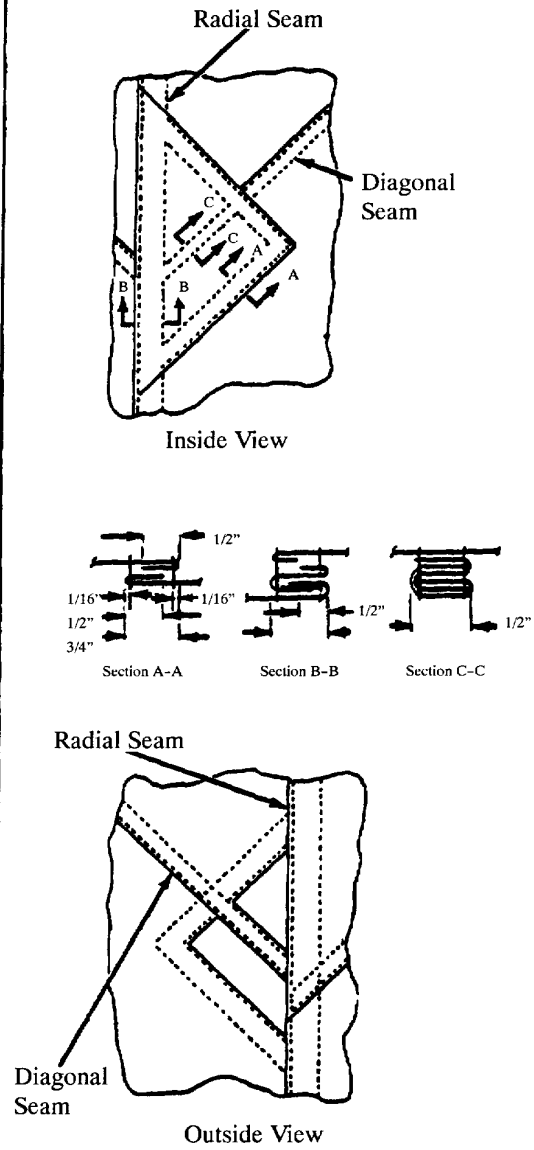

(G) Triangular Patch Crossing Diagonal Seam And Including Radial Seam

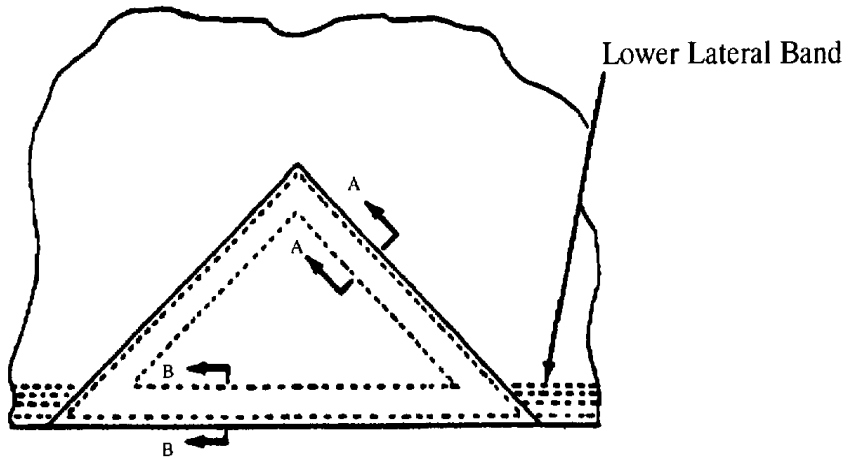

Inside View

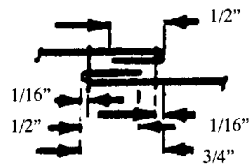

Section A-A



Section B-B

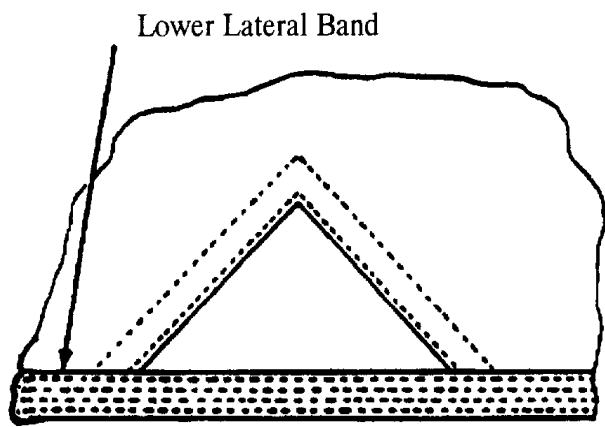

Inside View

(H) Triangular Patch Including Lower Lateral Band

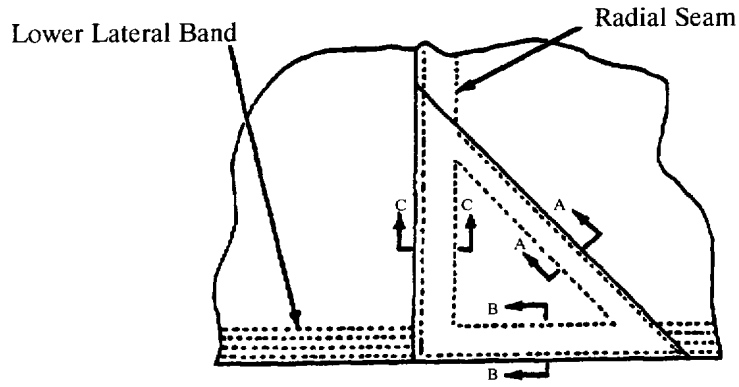

Inside View

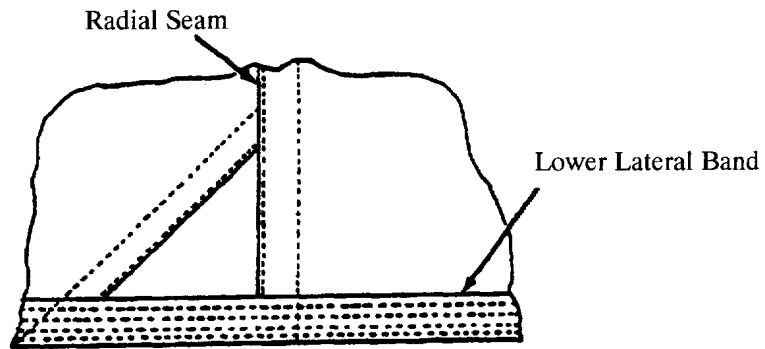

Outside View

- ① Triangular Patch Including Radial Seam And Lower Lateral Band

END OF WORK PACKAGE

UNIT MAINTENANCE
MC1-1C/MC1-1D TROOP BACK PARACHUTE ASSEMBLY
SEARING AND WAXING

THIS TASK COVERS:

- Searing
 - Waxing
-

INITIAL SETUP:**Tools**

Pot, Melting, Electric (Item 24, WP 0042 00)
Knife, Hot, Metal (Item 14, WP 0042 00)

Personnel Required

92R(10) Parachute Rigger

Materials/Parts

Beeswax (Item 2, WP 0055 00)
Wax, Paraffin (Item 55, WP 0055 00)

Equipment Condition

Unpacked.

CAUTION

Cotton tape, webbing, or cord will not be seared.

NOTE

Fabric materials such as cord, tape, and webbing, that are cut for use in the maintenance of the MC1-1C/MC1-1D parachute, will normally be heat-seared or dipped in a melted wax mixture, as applicable, to prevent the material from fraying or unraveling. However, in some instances, the preparation of the material may not be necessary and will be specified accordingly.

SEARING

The cut ends of nylon tape, webbing and cord lengths may be prepared by heat-searing, which is performed by pressing the raw end of the material against a hot metal surface (knife) until the nylon has melted sufficiently. Avoid forming a sharp edge or lumped effect on the melted end.

WAXING

The fraying or unraveling of cotton or nylon tape, webbing, and cord length ends may be prevented by dipping ½-inch of the raw end of the material into a thoroughly melted mixture of half beeswax and half paraffin in an electric melting pot. The wax temperature should be substantial enough to ensure the wax completely penetrates the material, rather than just coating the exterior fabric.

END OF WORK PACKAGE

THIS PAGE INTENTIONALLY LEFT BLANK

UNIT MAINTENANCE
MC1-1C/MC1-1D TROOP BACK PARACHUTE ASSEMBLY
MARKING AND RESTENCILLING

THIS TASK COVERS:

- Marking
 - Restencilling
 - Remarking and Restencilling
-

INITIAL SETUP:**Materials/Parts**

Brush, Stenciling (Item 4, WP 0055 00)
Ink, Marking (Item 22, WP 0055 00)
Marker, Felt Tip, Black (Item 25, WP 0055 00)
Pen, Ball Point (Item 28, WP 0055 00)
Stencil Board, Oiled (Item 35, WP 0055 00)

Personnel Required

92R(10) Parachute Rigger

Equipment Condition

Laid out on packing table or other suitable area.

NOTE

Stenciling should be used whenever possible. A ballpoint pen or felt tip marker should be used only where stenciling is not possible, or when stenciling devices are not available. Any type ballpoint pen using black or blue ink may be used for marking on labels only.

Original stenciled data or marking that becomes faded, illegible, obliterated, or removed as a result of performing a repair procedure, will be remarked with a ballpoint pen, felt tip marker, or restenciled. All marking or restencilling will be done on, or as near as possible to, the original location and should conform to the original lettering type and size.

MARKING

Using marking devices, such as a ballpoint pen or felt tip marker, mark on, or as near as possible to, the original location and conform to the original lettering type and size.

RESTENCILLING

Proceed as follows:

1. Cut oiled stencil board to match the original lettering type and size of data to be restenciled.
2. Place cut stencil board over, or as near as possible to, the original marking to be restenciled.
3. Place an additional sheet of stencil board beneath the area to be restenciled to prevent the marking ink from penetrating to other areas.
4. Hold the stencil board in place and, using the stenciling brush filled with parachute marking ink, restencil the original marking.

REMARKING AND RESTENCILING

Remark/restencil the original stenciled data/markings that become faded, illegible, obliterated, or that have been removed as a result of performing a repair procedure. Ensure all marking/restencilling is on, or as near as possible to, the original location, and conforms to the original lettering type and size.

END OF WORK PACKAGE

UNIT MAINTENANCE
MC1-1C/MC1-1D TROOP BACK PARACHUTE ASSEMBLY
BRIDLE LOOP

THIS TASK COVERS:

- Repair
 - Replace
-

INITIAL SETUP:**Tools**

Knife (Item 13, WP 0042 00)
Knife, Hot Metal (Item 14, WP 0042 00)
Sewing Machine, Heavy-Duty (Table 1, WP 0012 00)
Shears (Item 28, WP 0042 00)

Personnel Required

92R(10) Parachute Rigger

Equipment Condition

Unpacked. Canopy laid flat.

Materials/Parts

Webbing, Nylon, Type VIII (Item 65, WP 0055 00)
Thread, Nylon, Size 6 (Item 54, WP 0055 00)

References

Group No. 01, MAC (WP 0045 00)
Table 1, WP 0012 00

REPAIR

Repair a bridle loop requiring restitching as follows:

1. Use a heavy-duty sewing machine to restitch any loose or broken stitches.
2. Restitch over the original stitch pattern using nylon thread, size 6. Overstitch $\frac{1}{2}$ -inch to lock stitches.

REPLACE

Replace a damaged or missing bridle loop by fabricating as follows:

1. Cut a 10-inch length of webbing, nylon type VIII, olive drab (OD). Sear the ends of the webbing.
2. Pass one end of the webbing through all of the canopy vent lines. Join both webbing ends together with a 2-inch overlap.

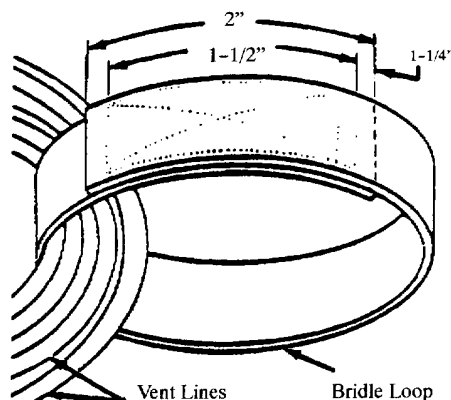

3. Begin at a point ¼-inch from one overlapped webbing end; use a heavy-duty sewing machine to secure the overlapped ends. With nylon thread, size 6, stitch a 1½-inch-long, single X-box stitch, and 5 to 8 stitches per inch.
4. Cut and remove the damaged bridle loop.

END OF WORK PACKAGE

UNIT MAINTENANCE
MC1-1C/MC1-1D TROOP BACK PARACHUTE ASSEMBLY
ORIFICE EDGE REINFORCEMENT

THIS TASK COVERS:

- Repair

INITIAL SETUP:**Tools**

Knife, Hot Metal (Item 14, WP 0042 00)
Sewing Machine, Light-Duty (Table 1, WP 0012 00)
Shears (Item 28, WP 0042 00)

Materials/Parts

Tape, Nylon, Type III, ¾-inch (Item 44, WP 0055 00)
Thread, Nylon, Size E (Item 49/52, WP 0055 00)

Personnel Required

92R(10) Parachute Rigger

Equipment Condition

Unpacked. Canopy in proper layout

References

Group No. 01, MAC (WP 0045 00)

NOTE

Both the upper and lower portions of the orifice edge reinforcement may be spliced once per gore.

REPAIR

Splice a damaged orifice edge reinforcement as follows:

1. Place the canopy on the repair table with the damaged area up; smooth the area around the damaged orifice edge reinforcement.
2. If only the orifice edge reinforcement is damaged, cut a length of type III, nylon tape, long enough to extend 4-inches beyond each side of the damaged area. Sear the ends of the tape. Center the tape over the damaged area, and stitch according to the original construction and Table 2, WP 0012 00.
3. If damage to the orifice edge reinforcement extends into gore section(s), and requires replacement of the section(s), place the canopy on the repair table, smooth the damaged area, and pin the section(s) to the table. Be sure the radial and diagonal seams are straight. Cut the orifice edge reinforcement, close to the radial seams (or radial and diagonal seams) that border the damaged area. Cut a length of type III, nylon tape, long enough to extend 4-inches beyond each radial seam (or each radial seam and diagonal seam) involved. Sear the ends of the tape. Baste the 4-inch ends of the tape in place. Replace the gore section(s) adapting procedures in WP 0036 00. Use the tape as a guide for trimming the edge of the new section(s). Turn-under the raw edge ½-inch, and stitch the tape in place using the same sewing machine, thread, and stitch range as specified in step 2., above.

END OF WORK PACKAGE

THIS PAGE INTENTIONALLY LEFT BLANK

UNIT MAINTENANCE
MC1-1C/MC1-1D TROOP BACK PARACHUTE ASSEMBLY
UPPER LATERAL BAND

THIS TASK COVERS:

- Repair
-

INITIAL SETUP:**Tools**

Knife (Item 13, WP 0042 00)
Knife, Hot Metal (Item 14, WP 0042 00)
Pot, Melting, Electric (Item 24, WP 0042 00)
Sewing Machine, Light-Duty (Table 1, WP 0012 00)
Sewing Machine, Medium-Duty (Table 1, WP
0012 00)
Shears (Item 28, WP 0042 00)

Materials/Parts

Wax, Paraffin (Item 55, WP 0055 00)
Thread, Nylon, Size E (Item 49/52, WP 0055 00)
Webbing, Nylon, 1-in., Tubular (Item 61, WP 0055 00)

Personnel Required

92R(10) Parachute Rigger

Equipment Condition

Unpacked. Canopy laid flat.

References

Group No. 01, MAC (WP 0045 00)
Table 1, WP 0012 00

REPAIR

1. *Restitching of the upper lateral band is authorized.* Use a light-duty sewing machine and size E, nylon thread of contrasting color. Stitch over the original stitch pattern. Lock each row of stitches 2-inches at each end.

NOTE

The upper lateral band may be spliced only once and will not be replaced.

2. *Damage Between Radial Seams:*
 - a. Cut stitching of two apex/vent lines on each side of the damaged area and move the lines to one side.
 - b. Invert the apex and smooth the canopy around the damaged area.
 - c. Cut a piece of the 1-inch tubular nylon webbing long enough to extend 1-inch beyond the outside edge of the second radial seam, on each side of the damaged area. Sear or dip the ends of the webbing.

- d. Position the webbing on the damaged area. Use a medium-duty sewing machine and size E, nylon, thread to stitch. Sew webbing in place with four continuous rows of stitching, 7 to 11 stitches per inch. Overstitch the ends of the webbing 2-inches.

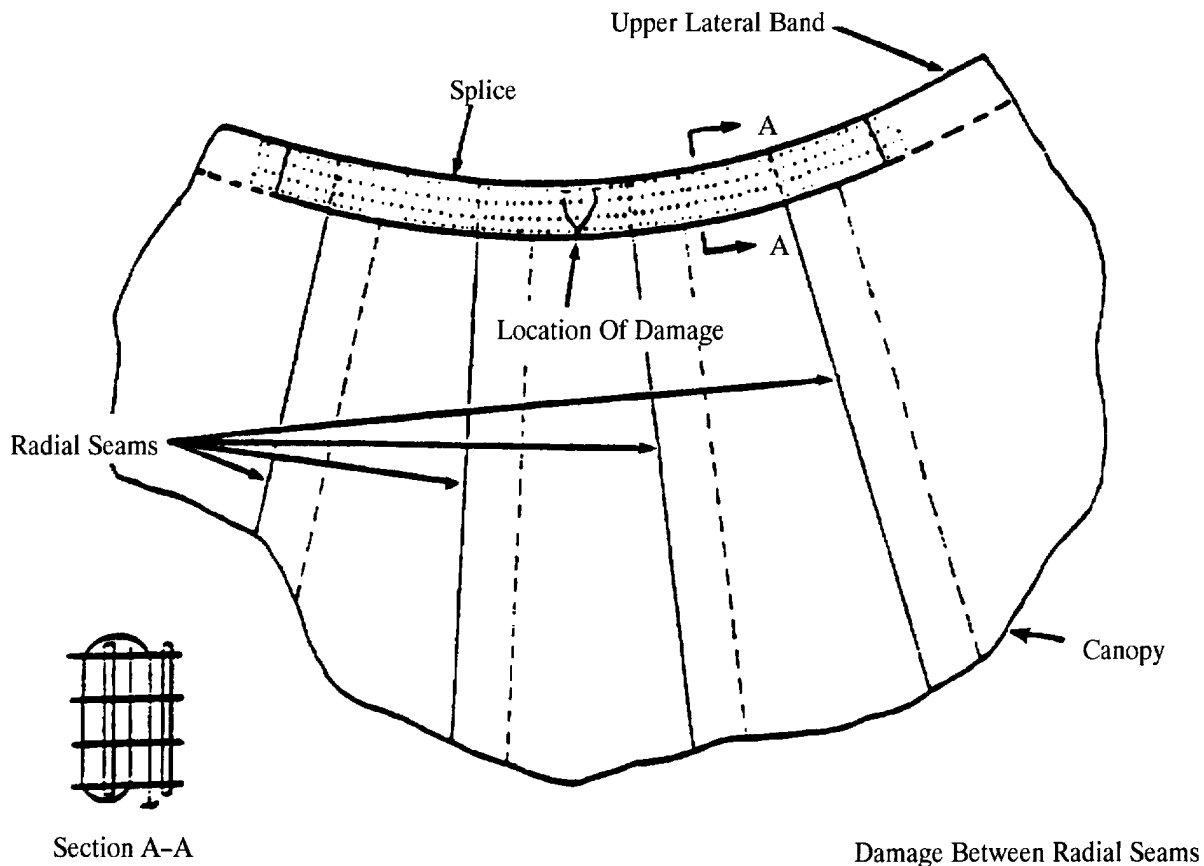

- e. Reposition apex/vent lines and sew them in place according to original construction.

3. *Damage Extending Into Radial Seam:*

- Cut the stitching of the apex/vent line attached to the damaged radial seam and the stitching of the two apex/vent lines on each side of the damaged seam. Move the lines to one side.
- Invert the apex and smooth the canopy around the damaged area.
- Cut a piece of 1-inch tubular, nylon webbing, long enough to extend 1-inch beyond the outside edge of the second radial seam, on each side of the damaged area. Sear or dip the ends of the webbing.

- d. Position the webbing on the damaged area. Use a medium-duty sewing machine and size E, nylon thread to stitch. Sew the webbing in place with four continuous rows of stitching, and 7 to 11 stitches per inch. Overstitch the ends of the webbing 2-inches.

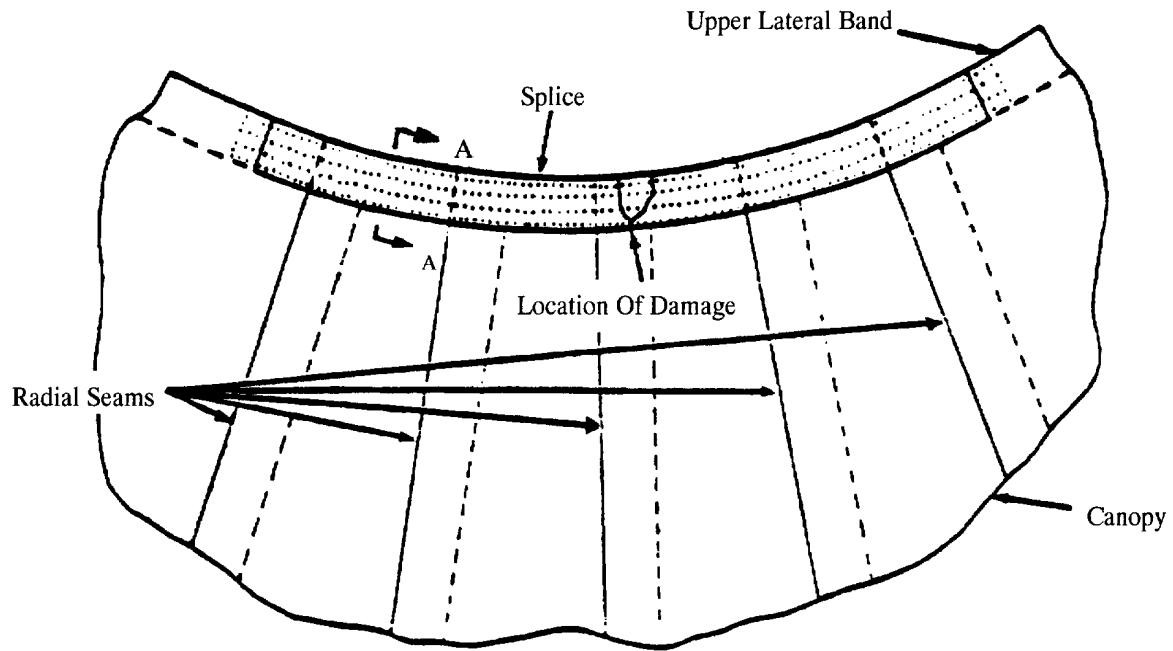

Damage Extending Into Radial Seam

- e. Reposition the apex/vent lines and sew them in place according to the original construction.

END OF WORK PACKAGE

THIS PAGE INTENTIONALLY LEFT BLANK

UNIT MAINTENANCE
MC1-1C/MC1-1D TROOP BACK PARACHUTE ASSEMBLY
GORE SECTIONS

THIS TASK COVERS:

- Repair
-

INITIAL SETUP:**Tools**

Knife (Item 13, WP 0042 00)
Needle, Basting (Item 18, WP 0042 00)
Sewing Machine, Light-Duty (Table 1, WP 0012 00)
Sewing Machine, Medium-Duty (Table 1, WP 0012 00)
Sewing Machine, Darning, Lt.-Duty (Table 1, WP
0012 00)
Shears (Item 28, WP 0042 00)

Materials/Parts

Brush, Stenciling (Item 4, WP 0055 00)
Cloth, Parachute Mending (Item 11, WP 0055 00)
Cloth, Parachute, Nylon, Type 1 (Item 12/13, WP
0055 00)
Thread, Cotton (Item 48, WP 0055 00)
Thread, Nylon, Size A (Item 51, WP 0055 00)
Thread, Nylon, Size E (Item 49/52, WP 0055 00)
Stencil Board, Oiled (Item 35, WP 0055 00)

Personnel Required

92R(10) Parachute Rigger

Equipment Condition

Parachute canopy laid out on
table.

References

Group No. 01, MAC (WP 0045 00)
WP 0012 00 and WP 0014 00
Table 2, WP 0012 00

REPAIR

Repair gore sections by restitching, darning, patching, or restencilling, in accordance with WP 0012 00 and WP 0014 00. Darn holes that do not exceed ½-inch in length or diameter. Darning is limited to two holes per gore section. Stitching and darning will be done as specified in Table 2., WP 0012 00.

END OF WORK PACKAGE

THIS PAGE INTENTIONALLY LEFT BLANK

UNIT MAINTENANCE
MC1-1C/MC1-1D TROOP BACK PARACHUTE ASSEMBLY
RADIAL SEAM

THIS TASK COVERS:

- Repair

INITIAL SETUP:**Tools**

Knife (Item 13, WP 0042 00)
Needle, Basting (Item 18, WP 0042 00)
Sewing Machine, Light-Duty (Table 1, WP 0012 00)
Shears (Item 28, WP 0042 00)

Materials/Parts

Cloth, Parachute, Type I (Item 12/13, WP 0055 00)
Thread, Cotton (Item 48, WP 0055 00)
Thread, Nylon, Size A (Item 51, WP 0055 00)
Thread, Nylon, Size E (Item 49/52, WP 0055 00)
Pushpins (local purchase)

Personnel Required

92R(10) Parachute Rigger

Equipment Condition

Parachute canopy laid out on table.

References

Group No. 01, MAC (WP 0045 00)
Table 1, WP 0012 00; Table 2, WP 0012 00;
Table 3, WP 0012 00; WP 0012 00

REPAIR

Patching repairs the radial seam. There is no limit to the length of a miscellaneous patch made on a canopy radial seam. In addition, a radial seam may be patched on both the inside and the outside of a canopy, as required. Patch a damaged radial seam as follows:

1. Place the canopy on a repair table with the damaged side of the radial seam facing up.
2. As required, cut the applicable stitching to remove or lay aside items that may interfere with the patching process.
3. Smooth the canopy material surrounding the damaged area and secure the undamaged portion of the seam to the table with pushpins. Do not pin the damaged area of the seam.
4. Using the same type material as in the original canopy construction, cut a rectangular patch 3½-inches wider and 4-inches longer than the damaged area. If one piece of material is not long enough to achieve the cited size, join additional pieces of cut material with ½-inch-wide lapped seams.
5. Fold the patch material lengthwise and align the raw edges.
6. Center and secure the radial seam patch material over the damaged area with pushpins. Fold-under ½-inch on each side of the new patch material and secure each side with pins.
7. Fold-under 1-inch at each end of the new patch material and secure with pins. Baste both sides of the new patch to the canopy using the procedures in WP 0012 00.

8. Remove the pins securing the canopy to the repair table. Secure the patch to the radial seam by stitching; use the procedures in WP 0012 00 and the stitching specifics outlined in Tables 1 and 2, WP 0012 00. The patch will be secured with four rows of stitching.

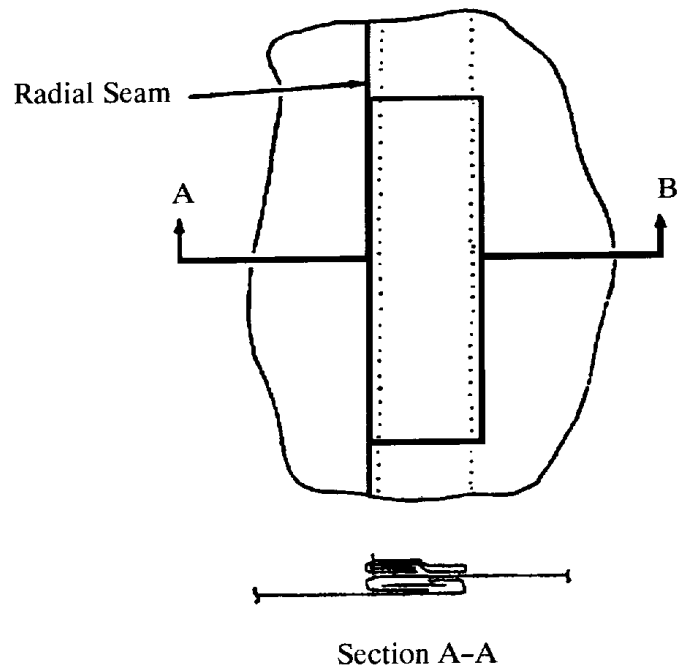

9. When applicable, repeat the stitching procedures in step 8., above, on the opposite side of the radial seam channel.
10. Reposition the items removed, or laid aside in step 2., above, in the original location; reattach each item to the canopy by restitching according to the original construction details and WP 0012 00. Stitching will be made using the stitching specifics cited in Tables 1 and 2, WP 0012 00.

END OF WORK PACKAGE

UNIT MAINTENANCE
MC1-1C/MC1-1D TROOP BACK PARACHUTE ASSEMBLY
LOWER LATERAL BAND

THIS TASK COVERS:

- Repair
-

INITIAL SETUP:**Tools**

Knife (Item 13, WP 0042 00)
 Knife, Hot Metal (Item 14, WP 0042 00)
 Pot, Melting, Electric (Item 24, WP 0042 00)
 Sewing Machine, Light-Duty (Table 1, WP 0012 00)
 Shears (Item 28, WP 0042 00)

Materials/Parts

Beeswax (Item 2, WP 0055 00)
 Tape, Nylon, Tubular, 1-Inch-wide (Item 42, WP
 0055 00)
 Thread, Nylon, Size E (Item 49/52, WP 0055 00)

Personnel Required

92R(10) Parachute Rigger

Equipment Condition

Unpacked. Laid out flat on repair table.

References

Group No. 01, MAC (WP 0045 00)

NOTE

The lower lateral band may be spliced in three places. In the event of damage between two suspension lines, where a splice has been used previously, it must be removed and replaced. Either side may be spliced, depending on the location of the damage.

REPAIR

1. *Damage Between Radial Seams.* Repair as follows:
 - a. Cut the stitching of the suspension line, V-tab, and pocket band (when applicable) on each side of the damaged area.

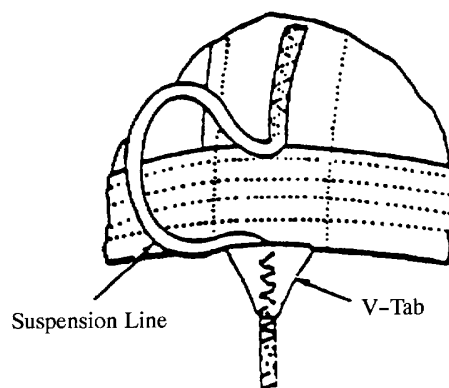

Stitching Removed

- b. Invert the canopy and smooth the canopy around the damaged area.
- c. Cut a piece of natural, 1-inch, tubular cotton-filled nylon tape, long enough to extend 6-inches on each side of the damaged area.
- d. Position the tape over the damaged area of the lateral band. Using a light-duty sewing machine, and size E, nylon thread, stitch in place with four continuous rows of stitching, 7 to 11 stitches per inch. Overstitch the ends of the tape by 2-inches.

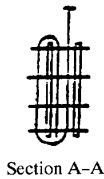
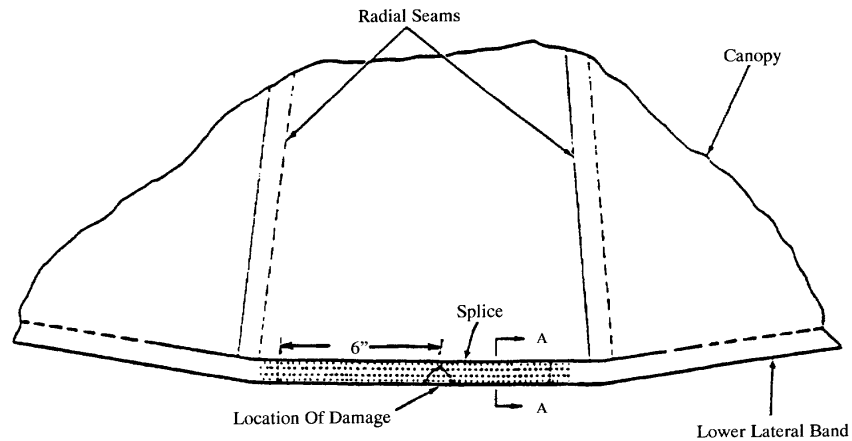

- e. Reposition the suspension lines, V-tabs, and pocket band; sew in place according to the original construction.

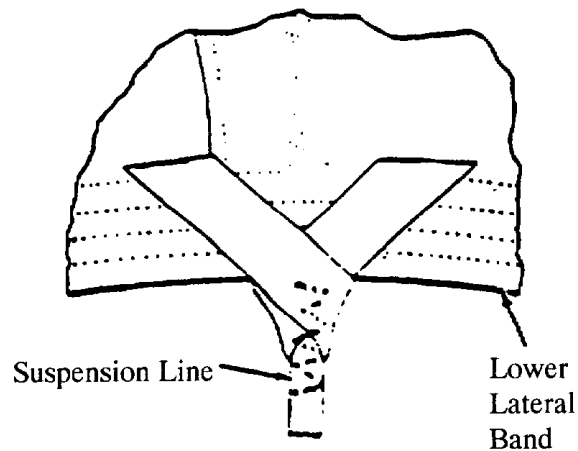

2. *Damage Extending Into Radial Seams.* Repair as follows:

- a. Cut the stitching of the suspension lines, V-tabs, and pocket bands at the damaged radial seam on each side of the damaged area. Move these items to one side.

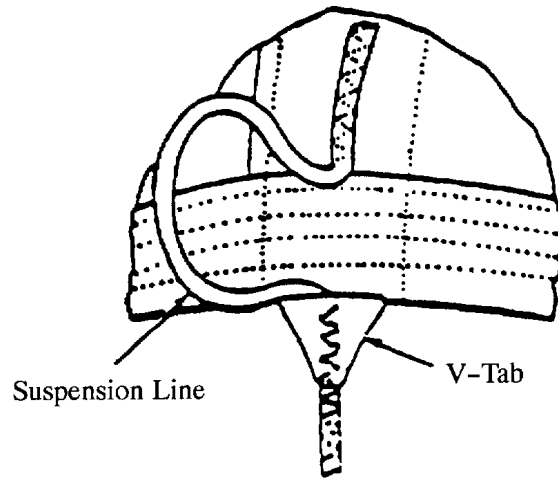

Stitching Removed

- b. Invert the canopy and smooth the canopy around the damaged area.
- c. Cut a piece of 1-inch, tubular nylon tape, long enough to extend 6-inches beyond the outside edge of the radial seam on each side of the damaged area. Sear or dip the ends of the webbing.

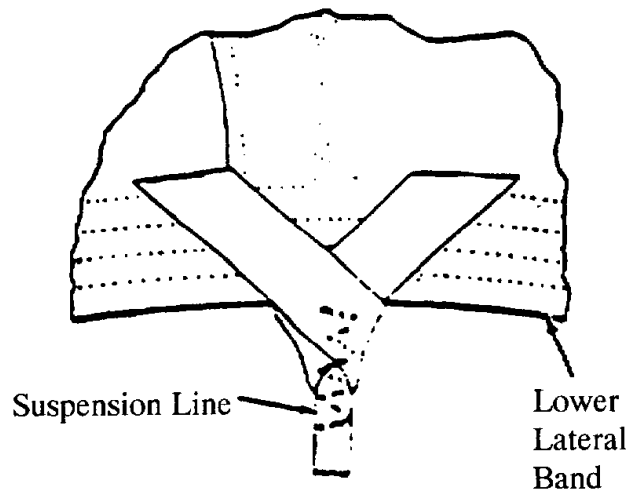

- d. Position the webbing on the damaged area. Using a light-duty sewing machine, and size E, nylon thread, sew the webbing in place with four continuous rows of stitching, 7 to 11 stitches per inch. Overstitch the ends of the webbing by 2-inches.

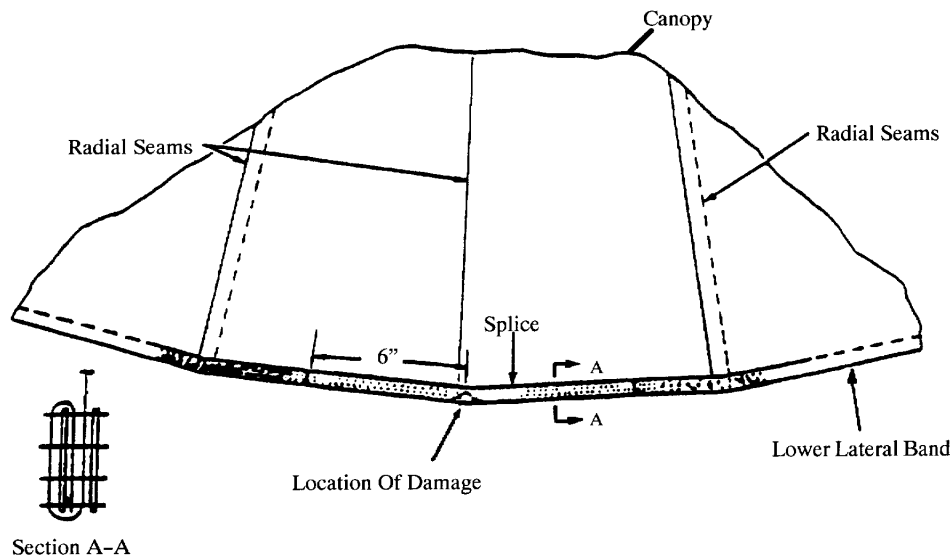

- e. Reposition the suspension lines, V-tabs, and pocket bands; sew in place according to the original construction.
3. *Stitching and Restitching.* Stitch and restitch with size E, nylon thread that matches the color of the original stitching, when possible. Lock all straight stitching by backstitching at least $\frac{1}{2}$ -inch. Restitch directly over the original stitching. Follow the original stitch pattern as closely as possible.

END OF WORK PACKAGE

UNIT MAINTENANCE
MC1-1C/MC1-1D TROOP BACK PARACHUTE ASSEMBLY
POCKET BAND

THIS TASK COVERS:

- Repair
 - Replace
-

INITIAL SETUP:**Tools**

Knife (Item 13, WP 0042 00)
Knife, Hot Metal (Item 14, WP 0042 00)
Pot, Melting, Electric (Item 24, WP 0042 00)
Sewing Machine, Light-Duty (Table 1, WP 0012 00)
Shears (Item 28, WP 0042 00)

Materials/Parts

Beeswax (Item 2, WP 0055 00)
Tape, Nylon, Tubular, Type I, 1-Inch Wide (Item 42,
WP 0055 00)
Thread, Nylon, Size E (Item 49/52, WP 0055 00)

Personnel Required

92R(10) Parachute Rigger

Equipment Condition

Unpacked. Laid flat on repair table.

References

Group No. 01, MAC (WP 0045 00)

REPAIR

Stitch and restitch with nylon thread, size E, that is contrasting in color. Lock all straight stitching by back stitching at least ½-inch. Restitch over the original stitch pattern.

REPLACE

When installed on a parachute canopy, a pocket band will be positioned on the outside of the lower lateral band, with a band end attached on each side of a suspension line, thereby allowing a free length of material to pass over the suspension line. A pocket band that is damaged will be replaced by fabricating using the following procedures:

1. Place the canopy assembly on a repair table, or other repair surface, with the damaged pocket band facing up.
2. Mark the lower lateral band, at each end of the damaged pocket band length.
3. Remove the affected pocket band from the canopy by cutting the stitching securing each of the band ends to the lower lateral band. Remove stitching on anti-inversion net and place out of the way until the pocket band is sewn.
4. Fabricate a new pocket band by cutting an 11¾-inch length of type I, tubular nylon tape; sear the ends.
5. Position the replacement pocket band length in the original pocket band location; align the material ends with the marks made in step 2., above.

- Secure each of the replacement pocket bands to the lower lateral band by stitching a 2-inch-long, single-X, box-stitch formation, with two double ends, 1/8-inch in from each edge. Use size E, nylon thread, 7 to 11 stitches per inch.

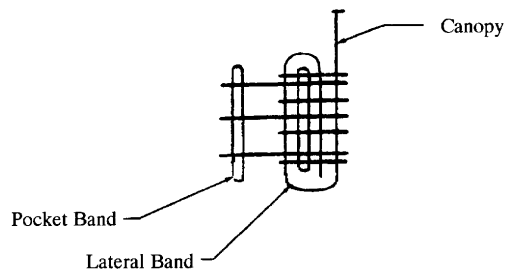
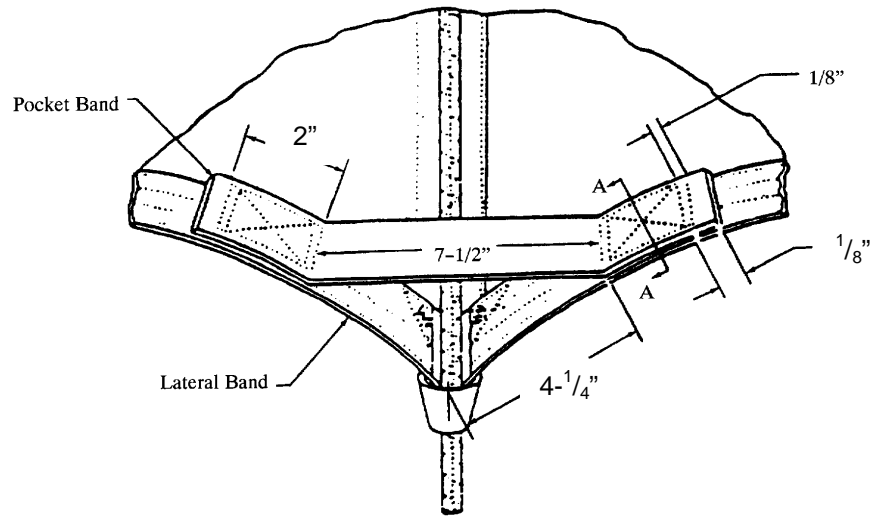

Section A-A

- Sew the anti-inversion net to the inside of the lower lateral band.

END OF WORK PACKAGE

UNIT MAINTENANCE
MC1-1C/MC1-1D TROOP BACK PARACHUTE ASSEMBLY
V-TABS

THIS TASK COVERS:

- Repair
 - Replace
-

INITIAL SETUP:**Tools**

Knife (Item 13, WP 0042 00)
 Knife, Hot Metal (Item 14, WP 0042 00)
 Sewing Machine, Light-Duty (Table 1, WP 0012 00)
 Sewing Machine, Medium-Duty, Zig-Zag (Table 1,
 WP 0012 00)
 Shears (Item 28, WP 0042 00)

Materials/Parts

Webbing, Nylon, Type I, 9/16-in. (Item 62, WP
 0055 00)
 Thread, Nylon, Size E (Item 49/52, WP 0055 00)

Personnel Required

92R(10) Parachute Rigger

Equipment Condition

Unpacked. Laid flat on repair table.

References

Group No. 01, MAC (WP 0045 00)

REPAIR

Stitch and restitch with nylon thread, that is the same size and contrasting in color to the original stitching, whenever possible. Lock all stitching by back stitching at least ½-inch. Restitch over the original stitch pattern.

REPLACE

Replace as follows:

1. Cut a 5-inch length of $\frac{9}{16}$ -inch-wide, type I, nylon webbing. Fold the webbing in half, cut the free ends on a 45-degree bias; sear the ends.
2. Position the canopy on the repair table, with the V-portion of the damaged tab up.

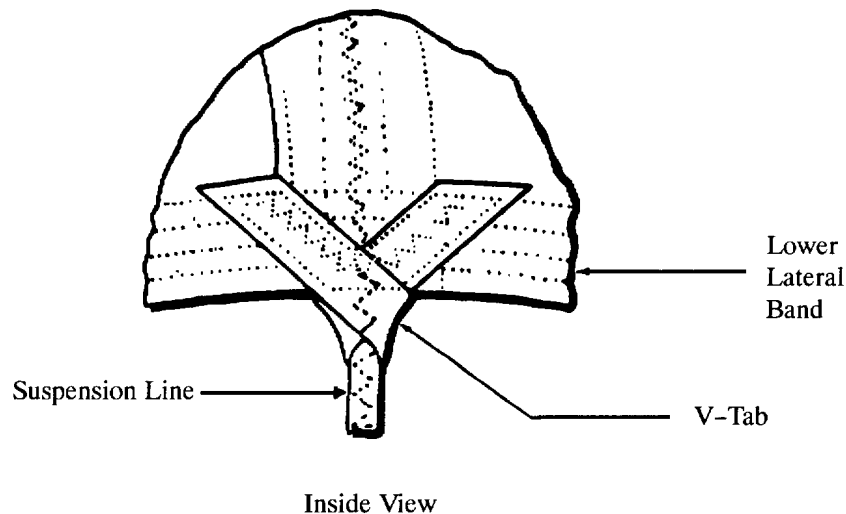

3. Mark the suspension line at the point where it crosses the lower edge of the lower lateral band.
4. Remove the damaged V-tab by cutting the stitching that holds the tab to the lower lateral band and the suspension line. Cut the stitching that holds the suspension line to the lower lateral band.

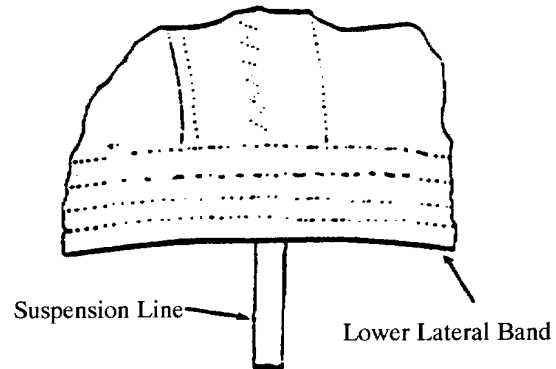

5. Center the new tab lengthwise under the suspension line, even with the lower edge of the lower lateral band. Wrap the tab tightly around the line, forming a V on the inside of the lower lateral band. Hand-tack the tab to the inside of the lower lateral band.

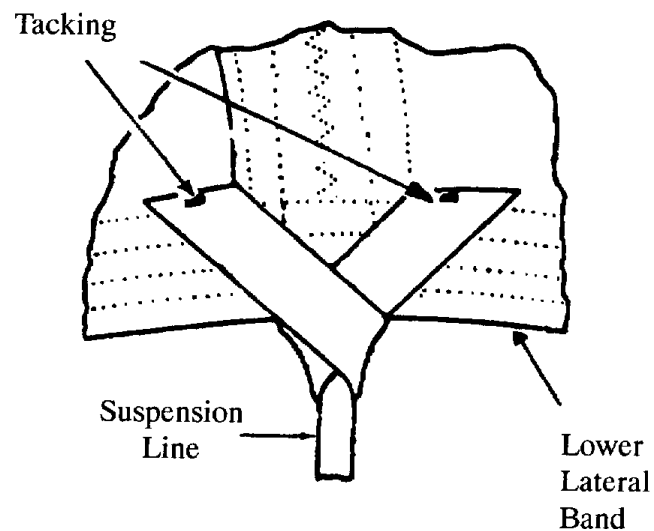

Inside View

**Bias-Trimmed V-Tab Ends Secured With
Temporary Tacking**

- Pull the suspension line up through the V-tab, and off to one side.

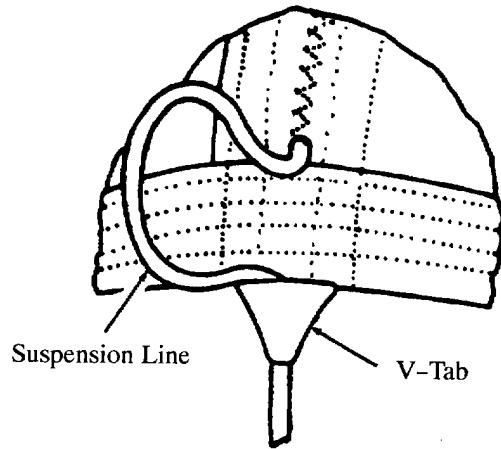

Outside View

Length Of Suspension Line Pulled Up Through V-Tab

- Sew the V-tabs to the inside of the lateral band, with both straight and zig-zag stitching; use nylon thread, size E. Hold the suspension line aside while sewing the V-tab.

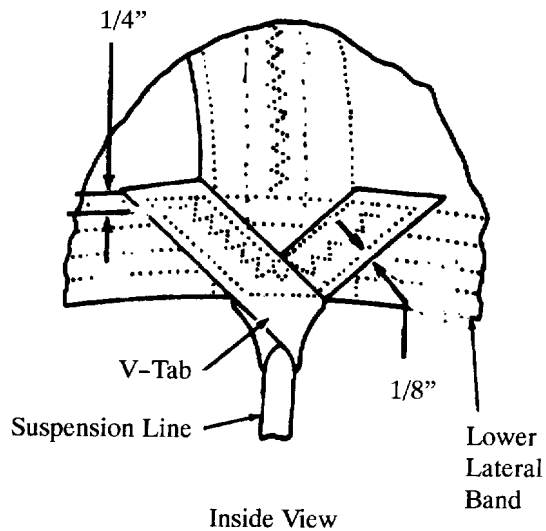

Inside View

V-Tab Ends Secured To Lower Lateral Band

8. Turn the canopy right side out, and reposition the suspension line; make certain the mark in step 3., above, is even with the lower edge of the lower lateral band.
9. Using a zig-zag sewing machine and size E, nylon thread, sew the suspension line in place. Begin stitching $\frac{1}{4}$ -inch below the V-tab; use 7 to 11 stitches per inch.

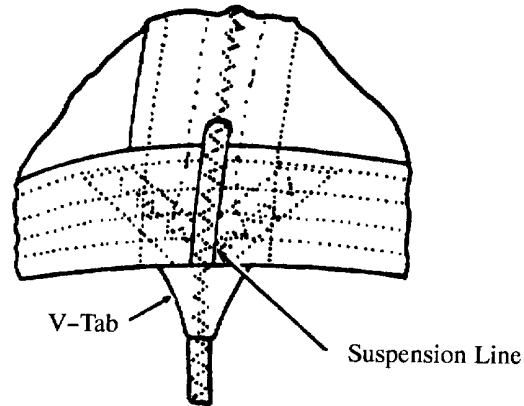

Outside View

Suspension Line Secured To V-Tab And
Canopy Skirt

END OF WORK PACKAGE

UNIT MAINTENANCE
MC1-1C/MC1-1D TROOP BACK PARACHUTE ASSEMBLY
ANTI-INVERSION NET

THIS TASK COVERS:

- Inspect and Repair
 - Replace
-

INITIAL SETUP:**Tools**

Knife (Item 13, WP 0042 00)
Sewing Machine, Light-Duty, Zig-Zag (Table 1,
WP 0012 00)
Sewing Machine, Medium-Light, Zig-Zag
(Table 1, WP 0012 00)
Presser Foot, Modified (WP 0056 00)
Shears (Item 28, WP 0042 00)

Materials/Parts

Cloth Netting, Nylon, 3¾-in. sq. Mesh, 18-in.
Width (Item 10, WP 0055 00)
Thread, Nylon, Size E (Item 49/52, WP 0055 00)

Personnel Required

92R(10) Parachute Rigger

Equipment Condition

Unpacked. Laid flat on repair table.

References

Group No. 01, MAC (WP 0045 00)
WP 0056 00

NOTE

The following procedures describe basic netting repairs normally required. This should not be understood to mean that these repairs are the only authorized repairs. Any time supervisory parachute maintenance personnel determine that other repairs are necessary to maintain the basic integrity of the net assembly, they may be made using the following basic criteria.

Procedures in WP 0056 00 may be used to modify the zig-zag sewing machine presser foot which will assist in the repair and replacement of the anti-inversion net.

INSPECT AND REPAIR

Due to the net not bearing any weight, the objectives in making repairs to the net are as follows: to prevent damage to the parachute's suspension lines and lower lateral bands; to avoid excessive accumulation of net material during repairs; and to maintain the net in a serviceable condition at minimum cost. To achieve these objectives, the following guidelines are to be followed in making inspections and repairs:

1. A limit of two horizontal and two vertical net cords may be broken in any one net section without repair. Trim the broken cord to within $\frac{1}{4}$ -inch from where the cord crosses the horizontal or vertical cord, as shown. Only one unrepaired break per net is permitted.

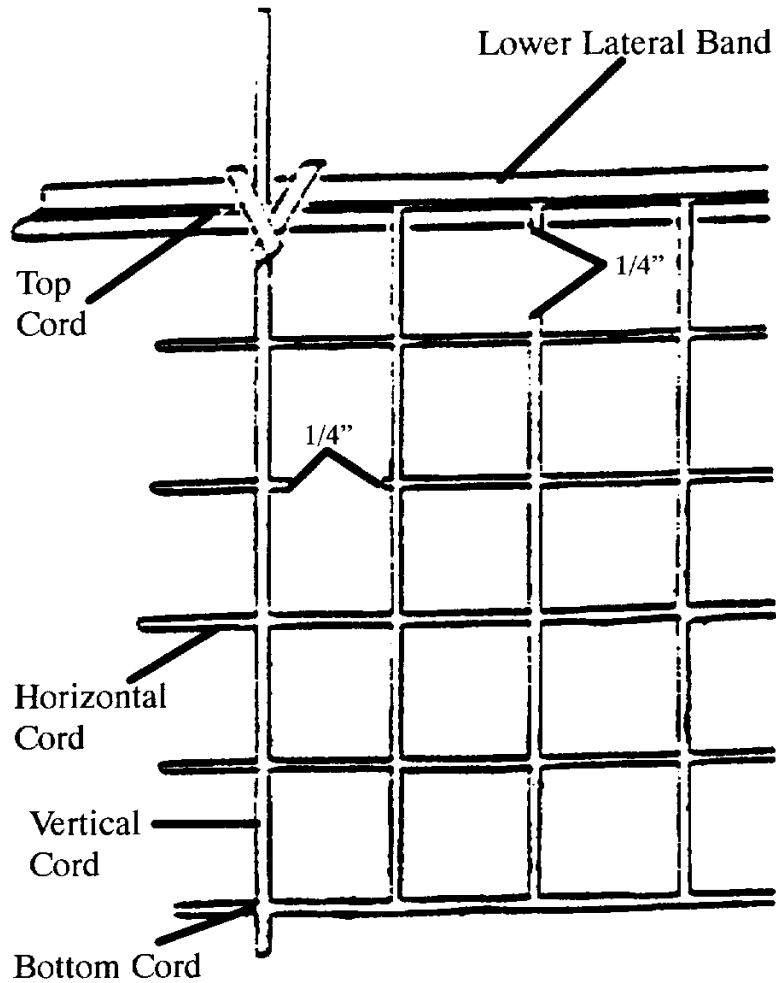

2. Broken net cords exceeding the number specified in step 1., above, and damaged net cords shall be repaired using a light duty zig-zag sewing machine, 5 to 8 stitches per inch, $\frac{1}{8}$ -inch-wide throw as illustrated below.

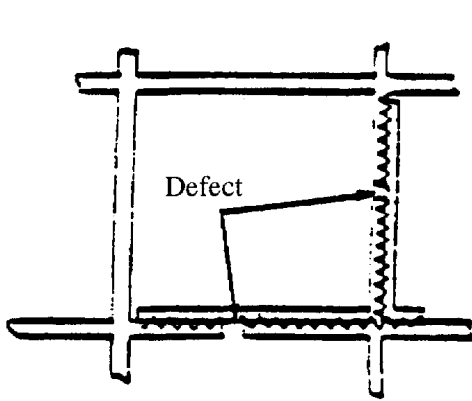

Repair To Vertical And Horizontal Cord In Same Square

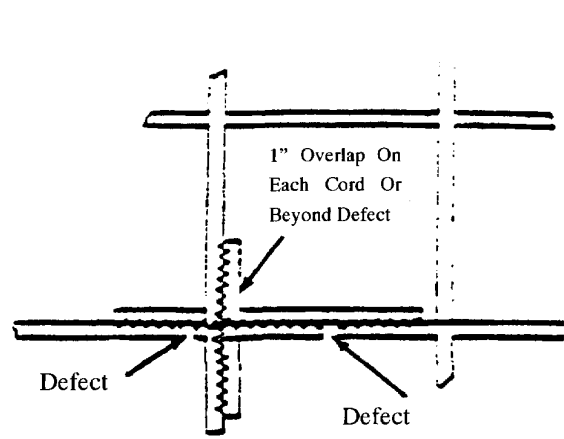

Repair To Horizontal Cords When One Defect Is Within 1-Inch Of Vertical Cord

Repair To Vertical Cords Attached To Top Cord

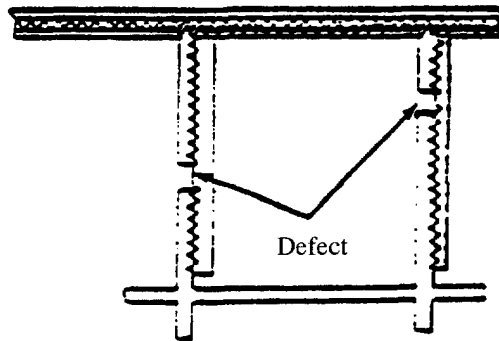

3. Damaged areas in the bottom cord must be repaired in accordance with A or B, using a light-duty zig-zag sewing machine, 5 to 8 stitches per inch, $\frac{1}{8}$ -inch-wide.

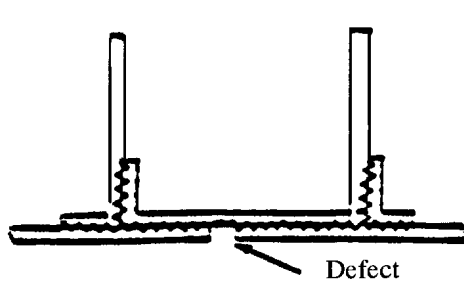

(A) Repair Of Botom Cord When Defect Is Over 1-Inch From Vertical Cord

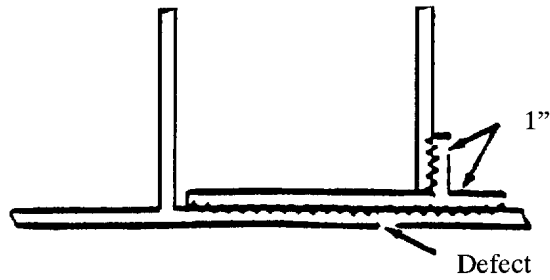

(B) Repair To Bottom Cord When Defect Is Within 1-Inch Of Vertical Cord

4. If damage is in a square next to a suspension line, exceeds limits, or would require zig-zag stitching to the suspension line, the netting should be cut and removed.

Repair To Net When Defect Is Less Than 1-Inch From Suspension Line

(Only Repair Stitching Shown)

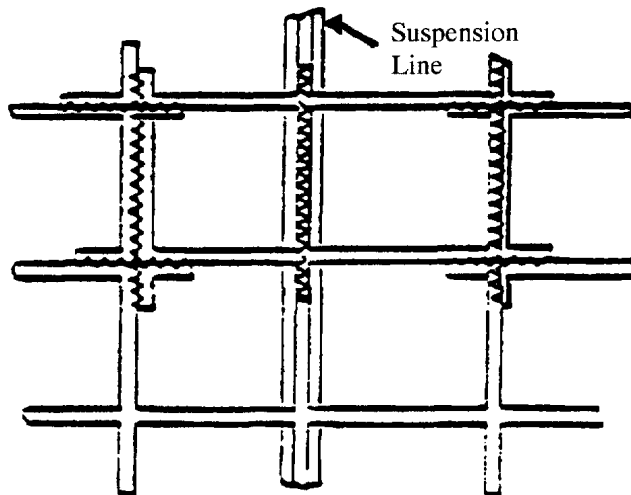

-
5. Carefully cut the zig-zag stitching loose from the suspension line. If the line is cut, the suspension line must be replaced. Butt the ends of the vertical cord of the new netting to the end of the cut vertical cord on the suspension line. Using a light-duty zig-zag sewing machine, 5 to 8 stitches per inch, $\frac{1}{8}$ -inch –wide throw, start zig-zag stitch $\frac{1}{2}$ -inch from new netting material. Stitch on the suspension line and $\frac{1}{2}$ -inch beyond the end.

REPLACE

If the net section requires replacement, remove the damaged area as follows:

1. Cut the vertical cords close to the top cord sewn to the lower lateral band.
2. Cut the horizontal cords, except for the top cord; leave one square length plus 1-inch on the outside of the suspension line, where possible.
3. Spread the new piece of netting over the removed section, with the top horizontal cord place below the old cord sewn to the lower lateral band.

CAUTION

Avoid removal of vertical net cord from suspension line, if possible. When replacement vertical net cord must be sewn to suspension line, the old cord shall be carefully removed.

NOTE

If there is insufficient horizontal cord on the inside of the suspension lines of the section being replaced to attach the replacement net, the horizontal net cords may be placed across the suspension line and sewn to other cords on each side of the suspension line. Sew a minimum of one inch by skipping over the suspension line or sewing cords together for 2-inches in the adjacent section and the section being replace.

4. Cut out a new section so the ends may be sewn together, using the method shown in illustrations C and D, below, as a guide. Use a light-duty zig-zag sewing machine, 5 to 8 stitches per inch, $\frac{1}{8}$ -inch-wide throw to sew the ends together. Use a medium duty, zig-zag sewing machine, 5 to 8 stitches per inch, $\frac{1}{8}$ -inch-wide throw to sew the net to the suspension line.

(C) Repair To Net When Defect Is Less Than 1-Inch From Suspension Line
(Only Repair Stitching Shown)

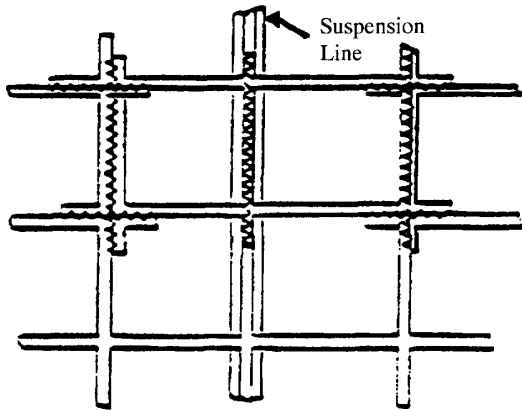

(D) Repair To Vertical Cords Attached To Top Cord

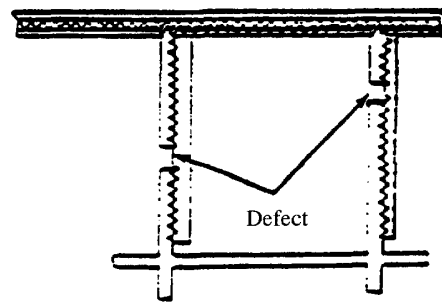

END OF WORK PACKAGE

UNIT MAINTENANCE
MC1-1C/MC1-1D TROOP BACK PARACHUTE ASSEMBLY
SUSPENSION LINE

THIS TASK COVERS:

- Repair
-

INITIAL SETUP:**Equipment Condition**

Unpacked. Laid flat on repair table.

Personnel Required

92R(10) Parachute Rigger

Tools

Knife (Item 13, WP 0042 00)
Knife, Hot Metal (Item 14, WP 0042 00)
Pot, Melting, Electric (Item 24, WP 0024 00)
Sewing Machine, Medium-Duty, Zig-Zag
(Table 1, WP 0012 00)
Shears (Item 28, WP 0042 00)

Materials/ Parts

Beeswax (Item 2, WP 0055 00)
Cord, Nylon, Type II (Item 14, WP 0055 00)
Thread, Nylon, Size E (Item 49/52, WP 0055 00)

References

Group No. 01, MAC (WP 0045 00)

REPAIR

Stitch and restitch, using a zig-zag pattern, 7 to 11 stitches per inch, with size E, nylon thread that is contrasting in color to the original material. Restitch over the original pattern.

END OF WORK PACKAGE

THIS PAGE INTENTIONALLY LEFT BLANK

UNIT MAINTENANCE
MC1-1C/MC1-1D TROOP BACK PARACHUTE ASSEMBLY
CONTROL LINE BRIDLE

THIS TASK COVERS:

- Repair
 - Replace
-

INITIAL SETUP:**Equipment Condition**

Control line bridle laid out on table.

Tools

Knife (Item 13, WP 0042 00)
Knife, Hot, Metal (Item 14, WP 0042 00)
Pot, Melting, Electric (Item 24, WP 0042 00)
Sewing Machine, Zig-Zag (Table 1, WP 0012 00)
Shears (Item 28, WP 0042 00)

Materials/ Parts

Beeswax (Item 2, WP 0055 00)
Cord, Nylon, Type II (Item 14, WP 0055 00)
Reefing Ring (Item 32, WP 0055 00)
Thread, Nylon (Item 49/52, WP 0055 00)

References

Group No. 01, MAC (WP 0045 00)

Personnel Required

92R(10) Parachute Rigger

REPAIR

Stitch and restitch with size E, nylon thread that is contrasting in color to the material. Restitch over the original pattern.

REPLACE

Replace a control line bridle as follows:

1. Place the canopy in proper layout on a repair surface; trace the control line bridle from one radial seam, through the control line reefing ring, to the opposite radial seam.
2. Make a mark at the lower end of the two stitch formations; secure the original control line bridle to the canopy.
3. Working through the canopy orifice ports, remove the original control line bridle by carefully cutting the stitching that secures the bridle to the canopy at two points. Ensure the canopy fabric is not damaged during the cutting process.
4. Cut a 6-foot length of type II, nylon cord, for use as a control line bridle, and wax the ends.
5. Make a mark at a point 6-inches from each end of the cord length.
6. Align the 6-inch mark on one end of the cord length, with one mark made in step 2., above.

- Secure the positioned 6-inch cord end with a 6-inch-long, $\frac{5}{32}$ -inch-wide, double-throw, zig-zag stitch formation.

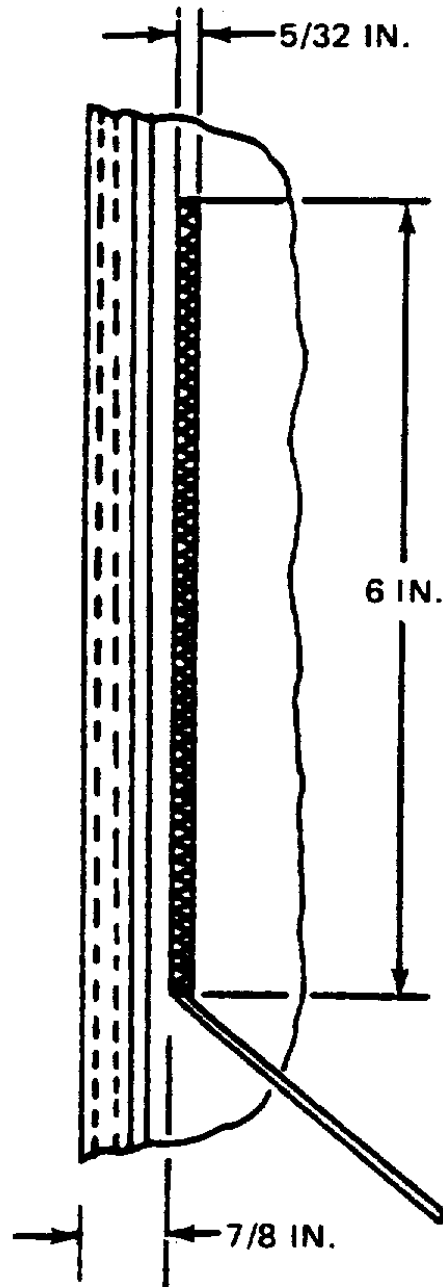

8. Pass the control line bridle free-end through the reefing ring attached at the top of the control line. Align the 6-inch mark on the bridle free-end, as outlined in step 6., above. Complete the control line bridle replacement by securing the bridle free-end, using the procedures in step 7., above.

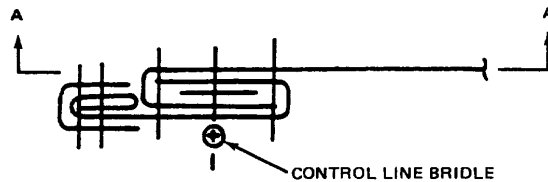
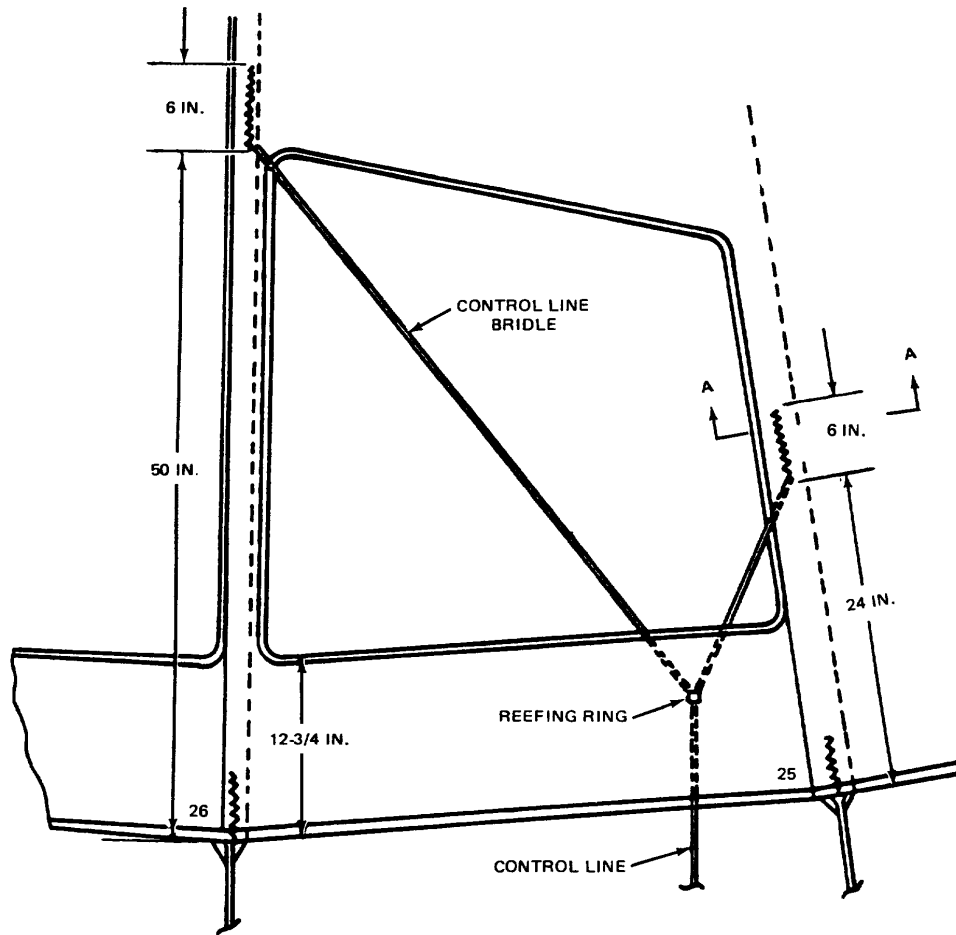

SECTION A-A

END OF WORK PACKAGE

THIS PAGE INTENTIONALLY LEFT BLANK

UNIT MAINTENANCE
MC1-1C/MC1-1D TROOP BACK PARACHUTE ASSEMBLY
CONTROL LINE

THIS TASK COVERS:

- Repair
 - Replace
-

INITIAL SETUP:**Equipment Condition**

Control line laid out on table.

Tools

Knife (Item 13, WP 0042 00)
 Knife, Hot, Metal (Item 14, WP 0042 00)
 Pot, Melting, Electric (Item 24, WP 0042 00)
 Sewing Machine, Zig-Zag (Table 1, WP 0012 00)
 Shears (Item 28, WP 0042 00)

Materials/ Parts

Beeswax (Item 2, WP 0055 00)
 Cord, Nylon, Type II (Item 14, WP 0055 00)
 Reefing Ring (Item 32, WP 0055 00)
 Thread, Nylon (Item 49/52, WP 0055 00)
 Tape, Masking, 1-Inch (Item 39, WP 0055 00)
 Dowel, Hardwood, $\frac{5}{8}$ -in. Diameter (Item 17, WP 0055 00)

Personnel Required

92R(10) Parachute Rigger

References

Group No. 01, MAC (WP 0045 00)

REPAIR

Stitch and restitch with size E, nylon thread that is contrasting in color to the material. Restitch over the original pattern.

REPLACE

Replace an unserviceable control line by fabricating as follows:

1. Place the canopy in proper layout on a repair surface and apply partial tension to the suspension lines.
2. Trace the applicable control line from the toggle to the control line bridle.
3. Remove the toggle from the control line bottom end.
4. Cut and remove the control line top end from the reefing ring through which the control line bridle passes.
5. Cut a 28½-foot length of type II, nylon cord, for use as a control line and wax the ends.
6. Make a mark at a point 4½-inches from one end of the cord length. Make a second mark at a point 1¼-inches above the first mark.
7. Pass the marked end of the cord length through the original control line reefing ring, located on the control line bridle, until the reefing ring is located between the two marks. Fold the cord length marked end back and align the two marks.

8. With the reefing ring position in the loop formed by the fold-back in the cord end, secure the control line to the reefing ring with a single row (4-inch-long, $\frac{3}{16}$ -inch-wide) double-throw, zig-zag stitch formation using 7 to 11 stitches per inch.

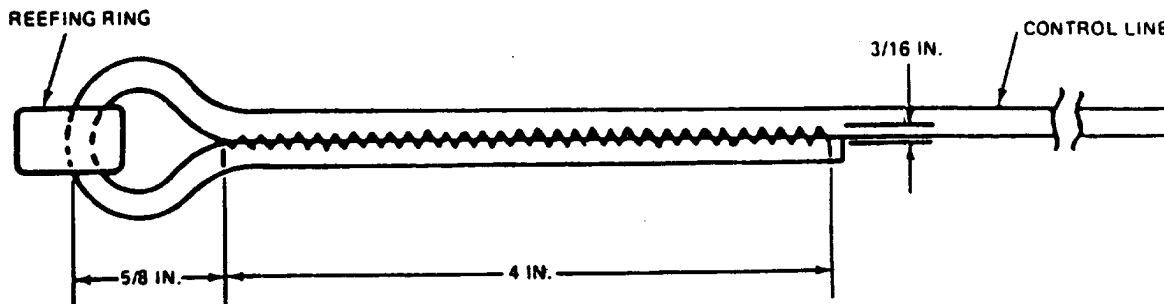

9. Trace each control line bridle and the attached control line from the point of attachment to the canopy to the free-end of the control line.
10. Pass the control line free-end from the top, through the channel guide ring (located on the inside of each rear riser), and further past the control line free-end, through a wood toggle. (Refer to the figure detailed below for toggle construction details, if required.)

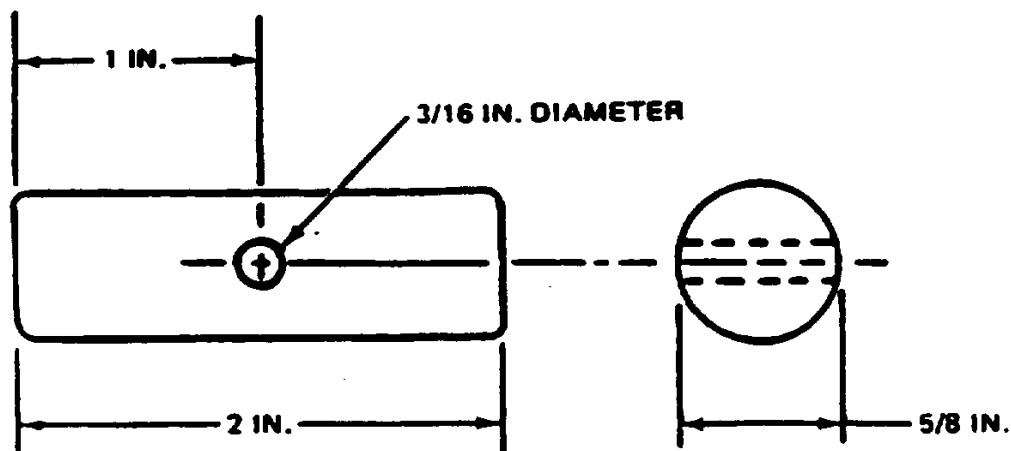

11. Position the toggle against the bottom of the guide ring and, while holding the toggle in position, pull the control line free-end taut until the control line tension equals that of the suspension lines. Move each toggle three inches from the channel guide ring. While holding each control line in position, place one inch wide masking tape on the control line just above the toggle, wrapping the tape around the riser once. Do not remove this tape.

12. Make two overhand knots in each control line against the bottom of each toggle. The remaining free end of each control line from the second overhand knot is to measure five inches. Then make the third overhand knot in the free end. Trim the control line free end at a point $\frac{1}{2}$ -inch below the third overhand knot.

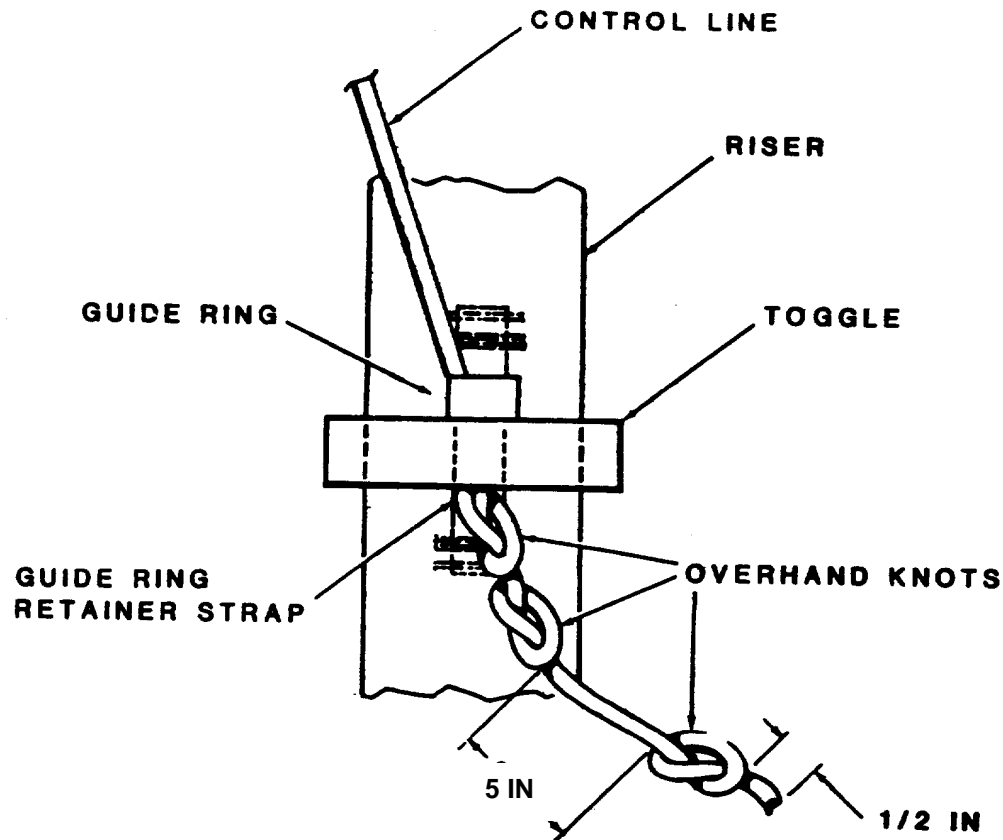

13. For parachutes with more than five jumps, position the control line toggles as follows:
- Undo the three overhand knots in each control line free end.
 - Again, position the toggle against the bottom of the guide ring and, while holding the toggle in position, pull both control line free-ends taut until the control line tension equals that of the suspension lines.
 - Secure the toggle by making two overhand knots against the bottom of the toggle. After the toggle is secured with the two overhand knots, check to make sure the toggle does not exert any pressure against the guide ring, on the guide ring retaining strap that is connected to the parachute riser.

- d. At a point 2-inches below the last overhand knot, make a third overhand knot in the control line free end. Trim the control line free end at a point $\frac{1}{2}$ -inch below the third overhand knot.

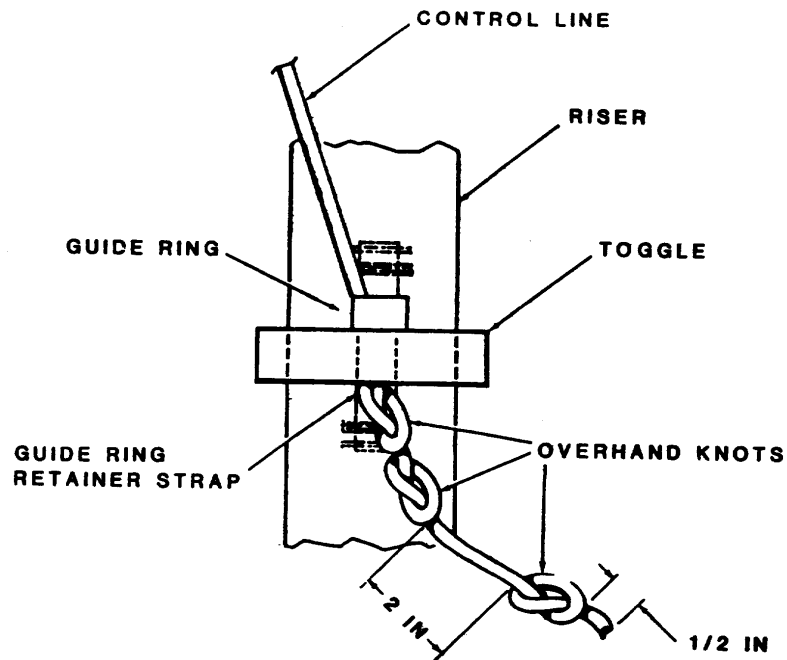

14. Annotation will be made in the note section of the parachute log record that the control line toggle adjustment procedure has been performed.

END OF WORK PACKAGE

UNIT MAINTENANCE
MC1-1C/MC1-1D TROOP BACK PARACHUTE ASSEMBLY
CONNECTOR LINK ASSEMBLY

THIS TASK COVERS:

- Repair
- Replace

INITIAL SETUP:**Equipment Condition**

Control links laid out on table..

Personnel Required

92R(10) Parachute Rigger

Tools

File (Item 8, WP 0042 00)
Mallet, Rawhide (Item 17, WP 0042 00)
Screwdriver, Flat-tip (Item 26, WP 0042 00)
Separator, Connector Link (Item 27, WP 0042 00)

Materials/ Parts

Cloth, Abrasive (Item 6, WP 0055 00)

References

Group No. 01, MAC (WP 0045 00)

NOTE

L-bar connector link assemblies are used on MC1-1C/MC1-1D personnel parachutes. Quick-fit link assemblies are not to be used on the MC1-1C/MC1-1D parachute.

REPAIR

Repair an L-bar connector link assembly as follows:

1. *Cleaning.* Remove burrs, rough spots, rust, or corrosion from a parachute connector link assembly by either filing with a metal file or by buffing with a crocus cloth.
2. *Replacing a locking screw.* Replace a damaged or missing locking screw on a parachute connector link with a serviceable item from stock.

REPLACE

A parachute connector link assembly, regardless of type, that is damaged beyond repair will be replaced with a serviceable L-bar parachute connector link assembly from stock. Use the following procedures:

1. Using a suitable sized, flat-tip (slotted-head) screwdriver, remove the two locking screws from the ends of a replacement L-bar parachute connector link assembly and disassemble the link.
2. Using a suitable sized, flat-tip (slotted-head) screwdriver, remove the two locking screws from the damaged, original parachute connector link assembly. Disassemble the link assembly, using a link separator, if necessary. If the connector link contains suspension lines, ensure the lines are not allowed to slide off the damaged link during the disassembly process.
3. As applicable, position an L-bar, of the replacement link assembly, adjacent to the disassembled original link assembly; slide the suspension lines from the damaged link onto the replacement link L-bar.

4. If required, pass the remaining L-bar of the replacement link through the attaching loop of the adjoining component.
5. Fit the replacement link L-bars together and ensure the L-bar leg is engaged by tapping the end of each L-bar with a rawhide mallet.
6. As applicable, trace the suspension lines from the connector link assembly to the canopy skirt to ensure the lines are properly installed and in the correct sequence.

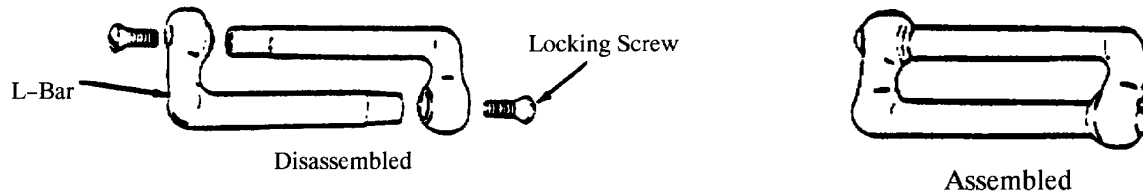

END OF WORK PACKAGE

UNIT MAINTENANCE
MC1-1C/MC1-1D TROOP BACK PARACHUTE ASSEMBLY
RISERS

THIS TASK COVERS:

- Repair
 - Replace
-

INITIAL SETUP:**Equipment Condition**

Unpacked.

Tools

Knife (Item 13, WP 0042 00)
 Knife, Hot Metal (Item 14, WP 0042 00)
 Separator, Connector Link (Item 27,
 WP 0042 00)
 Screwdriver, Flat-tip (Item 26, WP 0042 00)
 Sewing Machine, Medium-Duty (Table 1, WP
 0012 00)
 Shears (Item 28, WP 0042 00)

Personnel Required

92R(10) Parachute Rigger

Materials/ Parts

Reefing Ring, Control Line (Item 32,
 WP 0055 00)
 Tape, Adhesive, $\frac{1}{2}$ -Inch, Pressure Sensitive,
 Blue (Item 37, WP 0055 00)
 Tape, Nylon, Type III, $1\frac{1}{2}$ -inch-wide (Item 43,
 WP 0055 00)
 Thread, Nylon, Size E (Item 49/52, WP 0055 00)
 Webbing, Nylon, Type I, $\frac{9}{16}$ -inch wide (Item 62,
 WP 0055 00)

References

Group No. 02, MAC (WP 0046 00);WP 0003 00
 WP 0012 00, Tables 1 and 2

REPAIR

Repair a damaged riser assembly as follows:

1. *Repairing a guide ring and a guide ring-retaining strap.* Repair is limited to replace. Replace a damaged or missing guide ring and guide ring retaining strap as follows:
 - a. If applicable, remove the original guide ring, and guide ring-retaining strap, from the riser by cutting the stitching securing the strap to the riser. Ensure the riser webbing is not damaged during the cutting process.
 - b. If required, replace the guide ring (reefing ring) with a serviceable item from stock.
 - c. Cut a $4\frac{1}{2}$ -inch length of $\frac{9}{16}$ -inch-wide, type I, nylon webbing; sear the ends.
 - d. Fold the webbing and install a serviceable guide ring on the folded webbing according to the details illustrated on the next page.

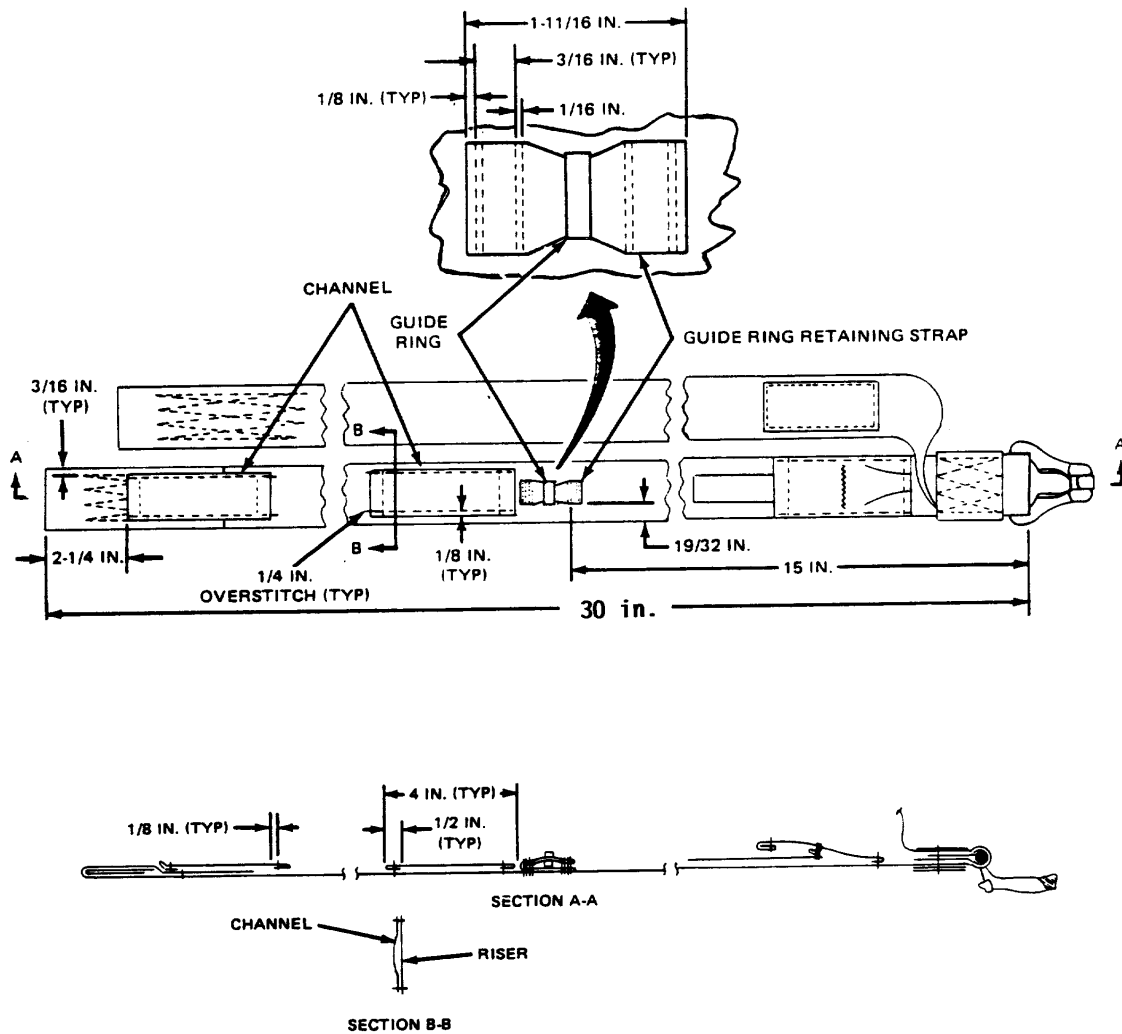

e. Secure the formed retaining strap with the guide ring, to the riser. Use a medium-duty sewing machine and size E nylon thread, and refer to the illustration above and Tables 1 and 2, WP 0012 00, as a reference.

2. *Replacing a control line channel.* Repair a damaged or missing control line channel by fabricating as follows:

- a. If applicable, remove an original control line channel from a riser by cutting the stitching securing the channel to the riser.
- b. Cut a 5-inch length of 1½-inch-wide, type III, nylon tape; sear the ends.
- c. Make a ½-inch-long fold-back on each end of the tape. Secure each fold-back by making a single row of stitching across the tape width at a point 1/8-inch back from the seared edged of the fold-back.

- d. Lock the stitching ends by $\frac{1}{2}$ -inch. Stitching will be made using a medium-duty sewing machine and size E, nylon thread (Tables 1 and 2, WP 0012 00).
- e. Position the stitched tape lengthwise on the riser in the original channel location or according to the details illustrated above, as applicable.
- f. Form the control line channel by securing the tape to the riser with a single row of stitching made $\frac{1}{8}$ -inch along each long edge of the tape. Overstitch each end of the tape by $\frac{1}{4}$ -inch. The stitching will be made using the specifics in Table 2, WP 0012 00.

REPLACE

Replace an unserviceable riser assembly as follows:

1. Remove the old risers by removing the screws and disassembling the link assemblies.
2. Obtain a serviceable riser assembly from stock.
3. When replacing a riser assembly, make certain the risers are not twisted and that, when the male canopy release fitting is facing down, the suspension lines are in proper sequence and location on the connector links.
4. Check the toggle attachment and trace the bottom end of the control line as illustrated below.

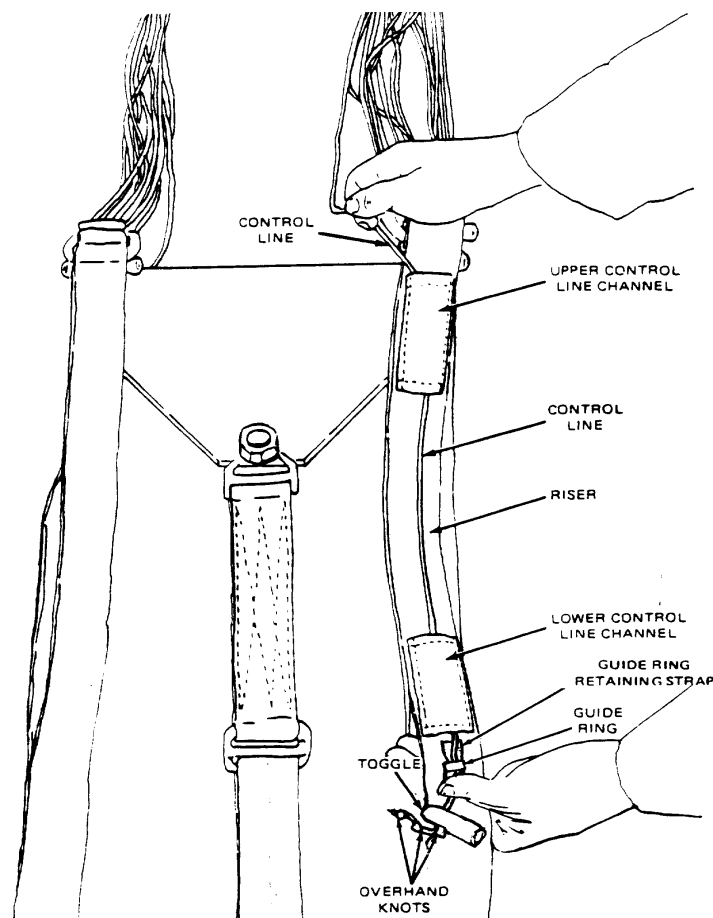

5. Replace the log record book in accordance with WP 0003 00.
6. Replace MC1-1C/MC1-1D identification markings by wrapping two turns, ½-inch blue, pressure sensitive adhesive tape around each riser assembly, centered on the confluence wrap.

END OF WORK PACKAGE

UNIT MAINTENANCE
MC1-1C/MC1-1D TROOP BACK PARACHUTE ASSEMBLY
DEPLOYMENT BAG

THIS TASK COVERS:

- Repair
- Replace

INITIAL SETUP:

Equipment Condition

Deployment bag clean with defects recorded.

Tools

- Knife (Item 13, WP 0042 00)
- Knife, Hot Metal (Item 14, WP 0042 00)
- Pot, Melting, Electric (Item 24, WP 0042 00)
- Sewing Machine, Light-Duty (Table 1, WP 0012 00)
- Sewing Machine, Medium-Duty (Table 1, WP 0012 00)
- Sewing Machine, Very Heavy-Duty (Table 1, WP 0012 00)
- Shears (Item 28, WP 0042 00)

Materials/ Parts

- Beeswax (Item 2, WP 0055 00)
- Cloth, Cotton, Sateen 8.2-oz. (Item 7, WP 0055 00)
- Cord, Nylon, Type II (Item 14, WP 0055 00)
- Thread, Nylon, Size E (Item 49/52, WP 0055 00)
- Thread, Nylon, Size 3 (Item 50/53, WP 0055 00)
- Thread, Nylon, Size 6 (Item 54, WP 0055 00)
- Webbing, Cotton, Type II (Item 58, WP 0055 00)
- Webbing, Nylon, Type I (Item 62, WP 0055 00)
- Webbing, Nylon, Type VIII (Item 65, WP 0055 00)
- Wire, Steel, 0.080 Diameter (Item 69, WP 0055 00)

Personnel Required

92R(10) Parachute Rigger

References

Group No. 03, MAC (WP 0047 00)
 WP 0012 00 and WP 0014 00

REPAIR

1. *General.* Two types of deployment bags are used with the MC1-1C/MC1-1D parachute: deployment bag with static line attached, standard, (A) and deployment bag without static line attached, USL (B).

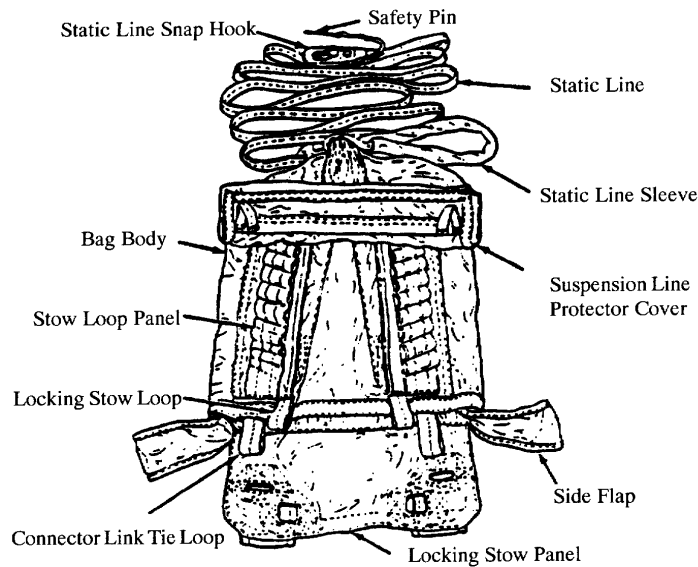

(A) Standard Deployment Bag

NOTE

The Navy is authorized to use deployment bag P/N 56D6276-4.

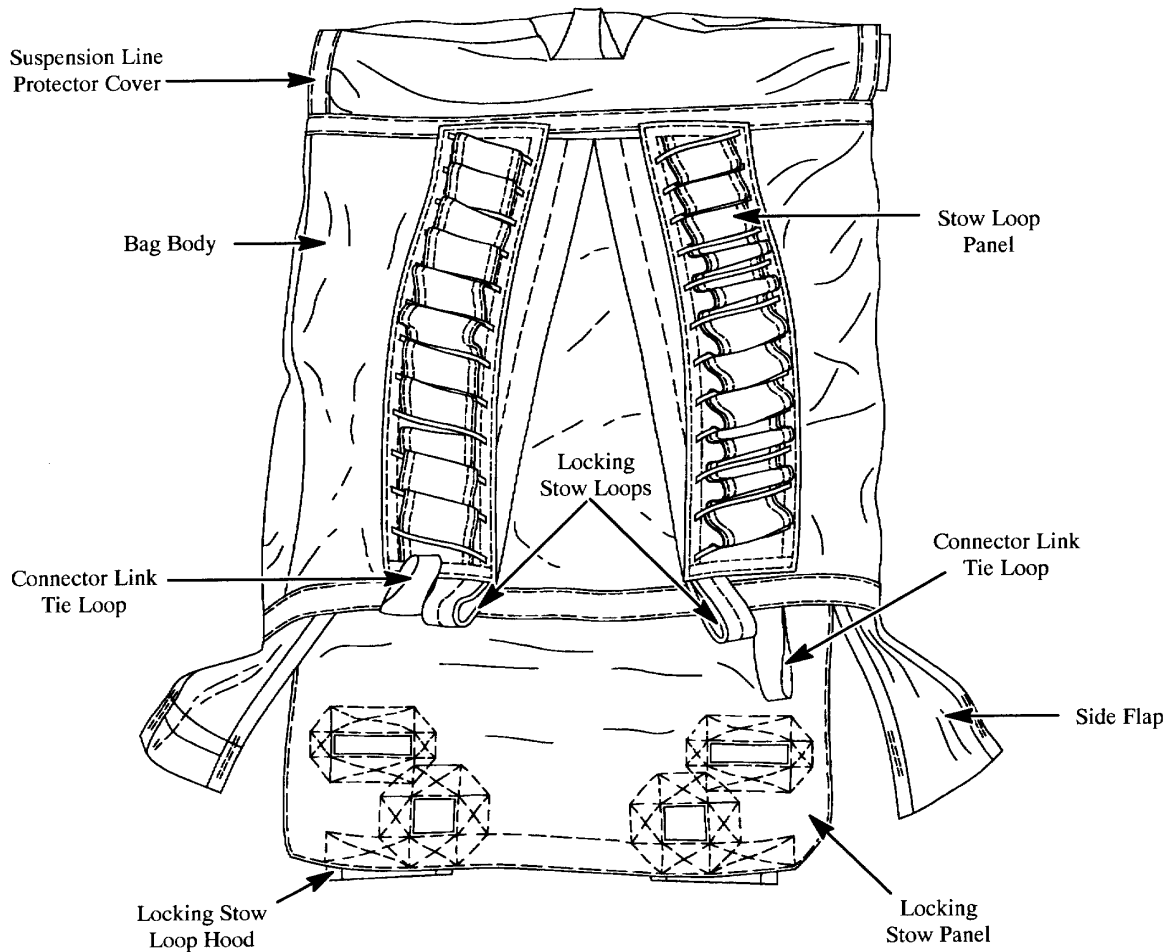

(B) Universal Static Line Deployment Bag

2. *Stitching.* Stitch and restitch with nylon thread, size E, that matches the color of the original stitching, when possible. Lock all straight stitching by backstitching at least $\frac{1}{2}$ -inch. Restitch directly over the original stitching; follow the original stitch pattern as closely as possible.
3. *Restencilling.* If necessary, restencil the bag number on the suspension line protector cover in accordance with WP 0014 00.
4. *Suspension line stow loop.* Repair stow loops as follows:

- a. *Permissible damage.* Two stow loops per panel may be torn, if the tear does not exceed $\frac{1}{2}$ the width of the loop, and the torn loops are not adjoining. Bags with tie closure may have closing loops torn up to $\frac{1}{2}$ the width.

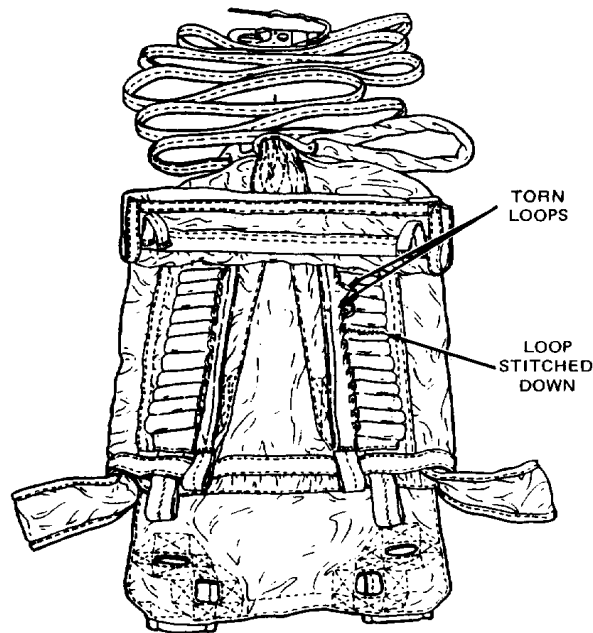

- b. *Restitching.* Proceed as follows:

- (1) Stow loops that are torn more than halfway through may be stitched down (making them unusable), provided a minimum of ten stow loops per stow panel remain. Use a medium-duty sewing machine with size 3, nylon thread to stitch 7 to 11 stitches per inch.
- (2) If fifty percent of stitching is loose or broken on one rolled stow, restitch the stow loop to the stow loop panel. If stitching in more than one adjacent rolled stow is broken more than $\frac{3}{4}$ of an inch in either stow, then restitch all stow loops on that side. Use a medium-duty sewing machine, size 3, nylon thread, and 7 to 11 stitches per inch.

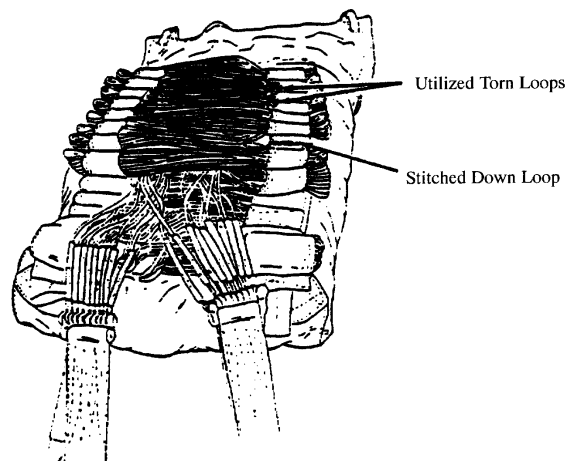

Suspension Lines Stowed
Utilizing Torn Stow Loops

5. *Darning.* Darning is a sewing procedure used to repair limited size holes, rips, and tears in assorted airdrop items constructed from textile material. A darning repair may be made either by hand or sewing machine, depending upon the method preferred and the availability of equipment. Refer to WP 0012 00, and use the following guidelines.

NOTE

A darning machine should be used to darn small holes and tears where fabric is missing.

- a. *Darning small holes or tears.* Darn small holes or tears in the main panel, reinforcement panel, side flaps, paddle pocket, locking stow panel, suspension line protector cover, and locking stow loop hood if the holes or tears do not exceed $\frac{3}{4}$ -inch in length or diameter. Use size E, nylon thread, and 7 to 11 stitches per inch.
- b. *Darning previously patched material.* Darning of previously patched material can be performed provided the darning size limitations prescribed in step a., above, are not exceeded.
- c. *Machine darning.* Proceed as follows:
 - (1) Using an authorized marking aid of contrasting color, mark a square around the undamaged area and ensure the marking is at least $\frac{1}{4}$ -inch back from each edge of the damaged area.
 - (2) Darn the damaged area by sewing the material in a back-and-forth manner.
 - (3) Turn the material and stitch back and forth across the stitching made in step 2., above, until the hole or tear is completely darned.

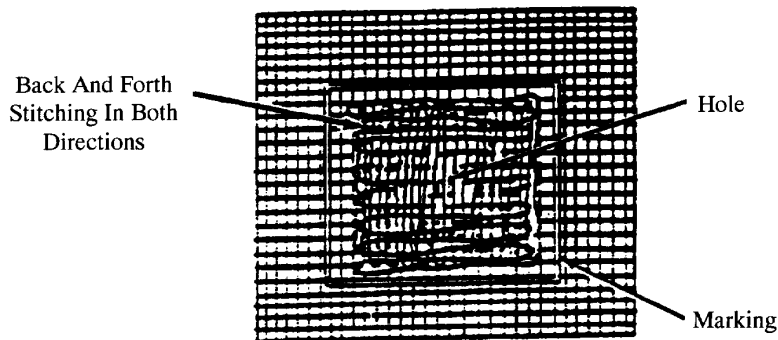

- (4) If applicable, restencil informational data, serial number(s), or identification marks in accordance with WP 0014 00.
6. *Patching.* Patch holes, in the suspension line protector cover, that exceed $\frac{3}{4}$ -inch in length or diameter. Proceed as follows:

- a. Place the repairable item on a repair table, smooth the fabric around the damaged area, and secure the item to the table with pushpins. Do not pin the damaged area.
- b. Using an authorized marking aid of contrasting color, mark a square or rectangle around the area to be patched.
- c. Cut the damaged area of fabric along the lines made in step 2., above. Further cut the fabric diagonally at each corner to allow a ½-inch fold-back in the raw edges.
- d. Make a ½-inch fold-back on each raw edge. Pin and baste each fold-back to complete the prepared hole.
- e. Using the same type material as in the original construction (8.2oz., cotton, sateen cloth) mark and cut a patch 2½-inches wider and longer than the inside measurements of the prepared hole.
- f. Center the patch material over the prepared. Pin the patch material in position.
- g. Make a ½-inch fold on each edge of the patch material and baste the patch to the prepared area.
- h. Remove the pushpins securing the item to the repair table; secure the patch by stitching. Use a light-duty sewing machine, size E, nylon thread, and 7 to 11 stitches per inch.

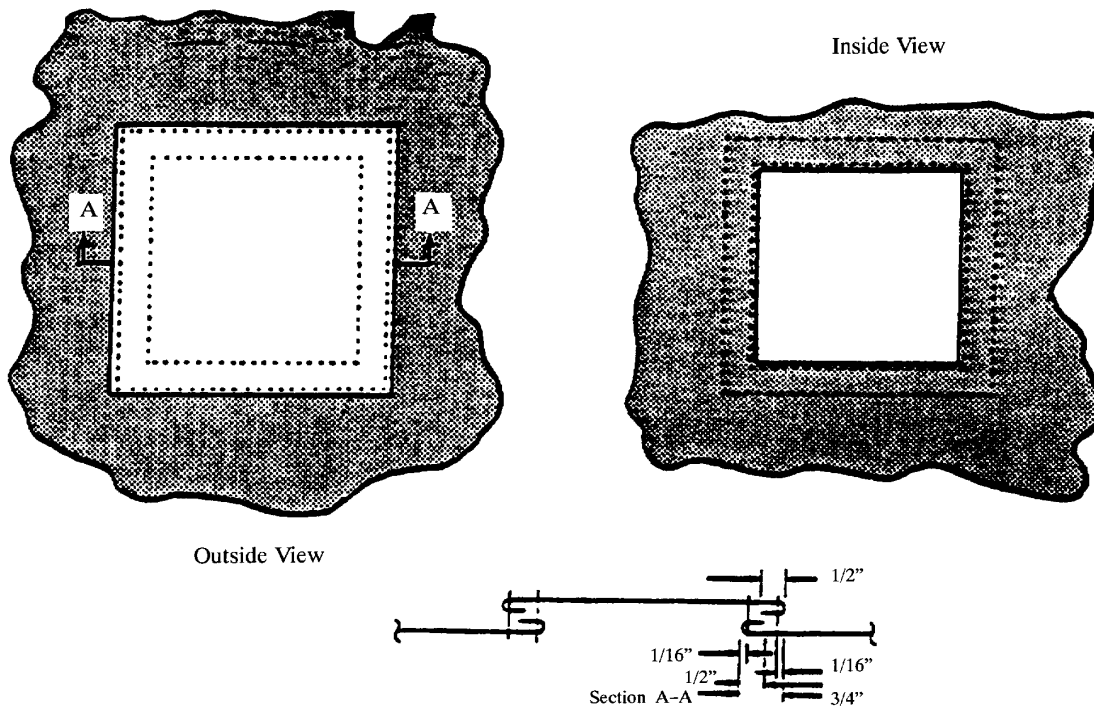

- i. Turn the item over and make a second row of stitching around the prepared hole; use a light-duty sewing machine, size E, nylon thread, and 7 to 11 stitches per inch.

7. *Reinforcing webbing.* Repair webbing as follows:

NOTE

Reinforcing webbing may be spliced one time.

- a. Cut a piece of type II, cotton webbing, long enough to extend 2-inches on each side of the damaged area. Dip the ends of the webbing in wax.

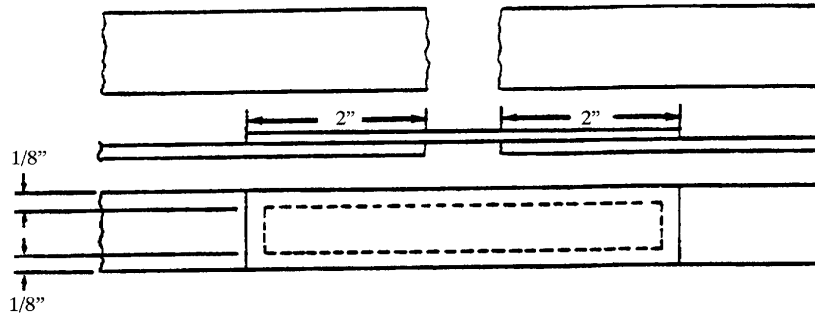

- b. Sew the webbing in place with a box-stitch formation; use a light-duty sewing machine, size E, nylon thread, and 7 to 11 stitches per inch.
- c. Outside stitching should be $\frac{1}{8}$ -inch in from the edge of the webbing. Lock stitches 1-inch.

8. *Locking stow loop hood.* Repair hood as follows:

- a. Cut the stitching and remove the damaged hood.
- b. Cut a $5\frac{7}{8}$ - by $2\frac{3}{4}$ -inch piece of 8.2-ounce cotton, sateen cloth; turn-under the $2\frac{3}{4}$ -inch edges $\frac{1}{4}$ -inch.

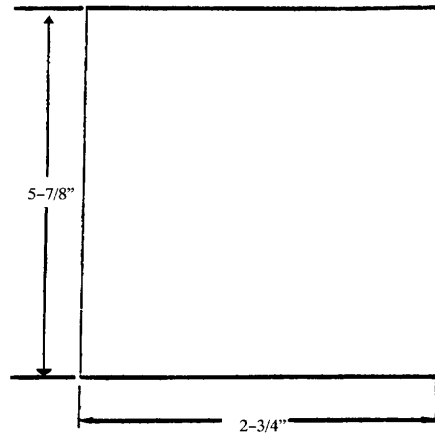

- c. Bind the $5\frac{7}{8}$ -inch edges with $\frac{3}{4}$ -inch, type III, cotton tape; turn-under ends of the tape $\frac{1}{2}$ -inch. Using a light-duty sewing machine, size E, nylon thread, and 7 to 11 stitches per inch; stitch the binding tape with two rows of stitches.

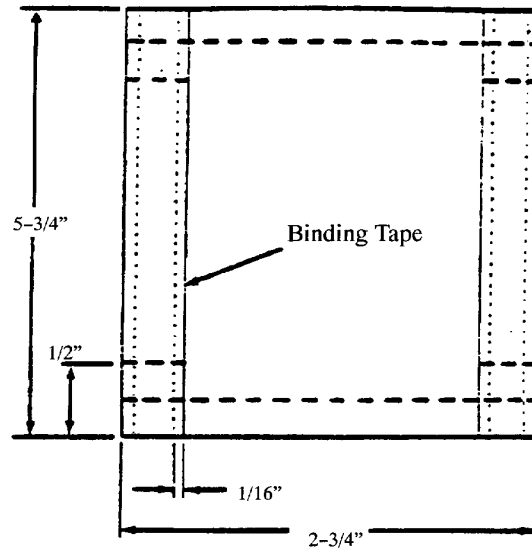

- d. Position the prepared locking stow loop hooked in the same place as the one removed. Stitch the hood in place using a light-duty sewing machine, size E, nylon thread, 7 to 11 stitches per inch in two box-X formations. The finished hood should not exceed 3-inches in width.

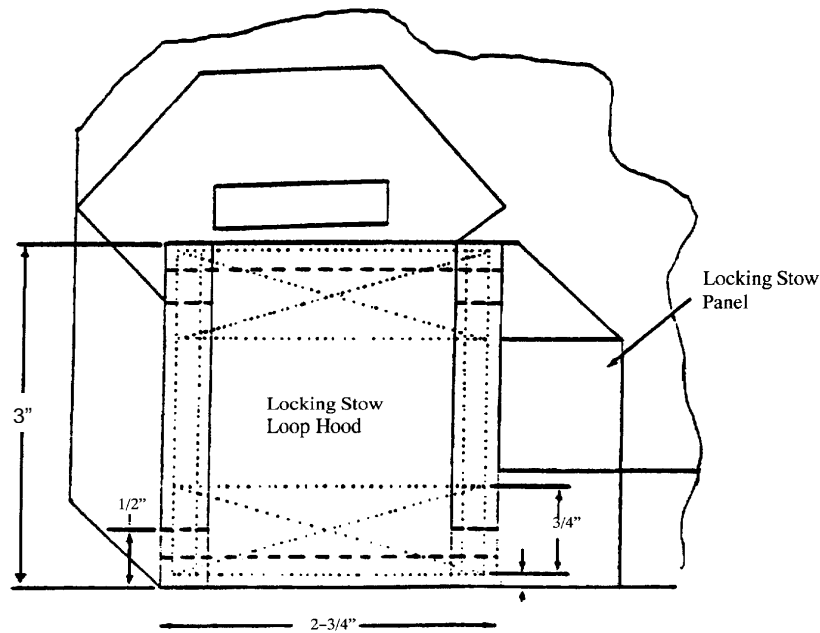

9. *Suspension line protector cover tie-down loop.* Repair the tie-down loops that are burned, frayed or torn over one-half of the loop, as follows:
 - a. Cut stitching, and remove damaged loop.
 - b. Cut a 6-inch length of $\frac{9}{16}$ -inch, type I, nylon webbing; wax ends of webbing.
 - c. Position the type I webbing in the same place the damaged material was removed. Align the two ends of the type I webbing, with the top of the webbing reinforcement.

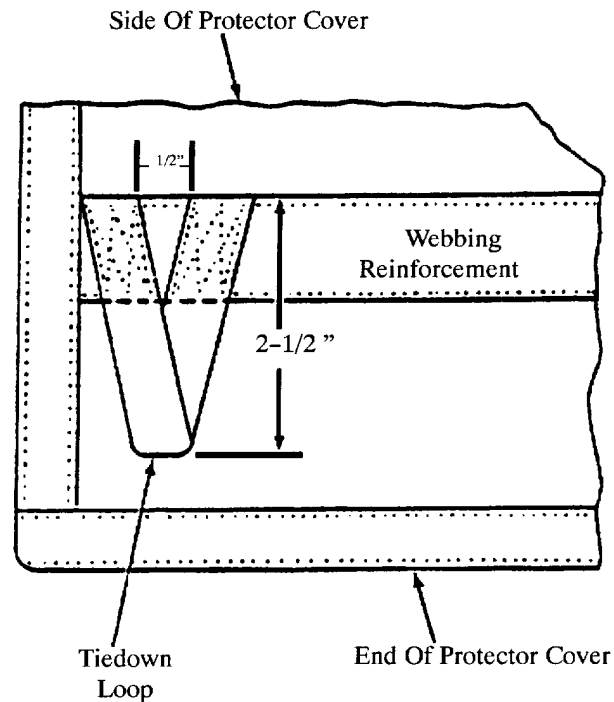

- d. Sew the loop in place on the underside of the protector cover with a 3-point WW stitch formation on each end of the webbing; stay on the webbing reinforcement. Use a light-duty sewing machine, size E, nylon thread, and 7 to 11 stitches per inch.
10. *Standard 15-foot Static line assembly.* Repair or replace a static line assembly as follows:

NOTE

The only repair permissible on the standard 15-foot static line is the replacement of the safety pin and the lanyard.

a. *Repair.* Proceed as follows:

- (1) Remove damaged lanyard or safety pin by cutting lanyard or untying knots securing the lanyard to the static line.
- (2) Cut a 5-inch length of 0.080-inch diameter corrosion resistant steel wire and form a $3\frac{1}{8}$ -inch safety pin.

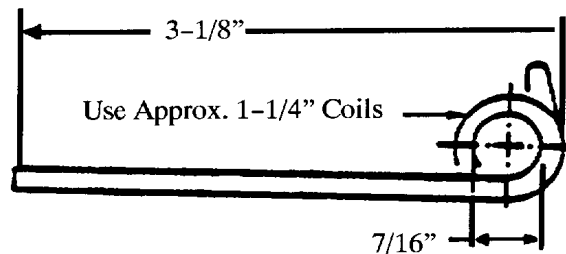

- (3) Remove the core cords from a 20-inch length of type II (or type III), nylon cord. Tie an overhand knot in each end and sear the ends. Fold the cord in half and attach to the safety pin with a girth-hitch.

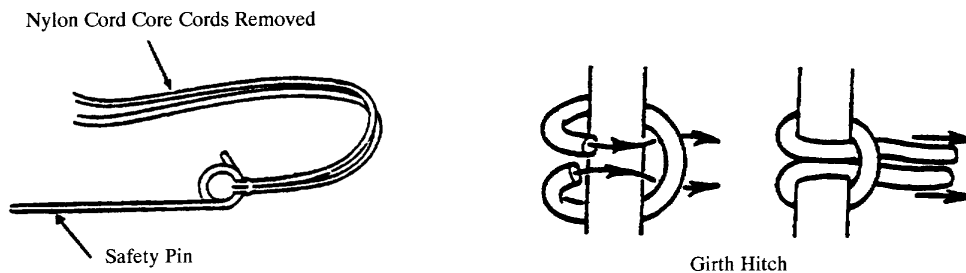

- (4) Tie an overhand knot in the cord no closer than 5-inches from the safety pin. Run one end of the cord through the static line loop, where the snap hook is attached, and secure on top of the static line with a surgeon's knot and a locking knot.

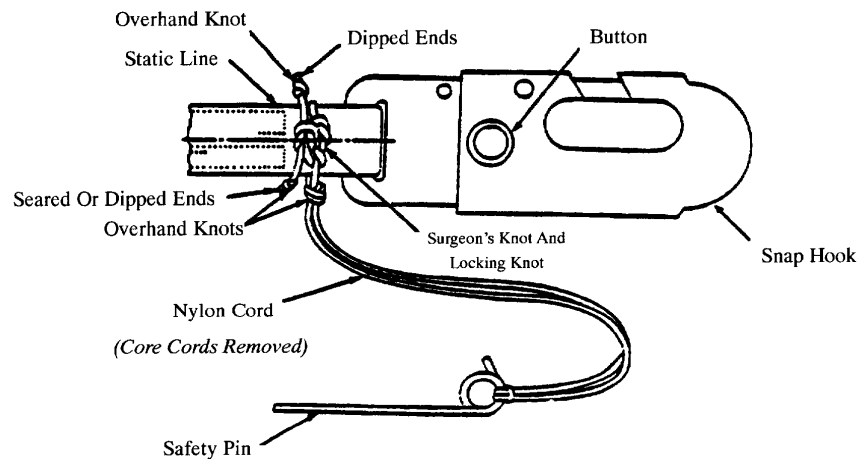

b. *Replace.* A standard 15-foot static line assembly that is damaged beyond repair must be replaced as follows:

- (1) Remove the damaged static line from the deployment bag.
- (2) Position the deployment bag, with the stow loop facing up, and pass the buffer end of the new line clockwise through the deployment bag reinforcement loop. Be sure the folded edge of the static line is facing inward.

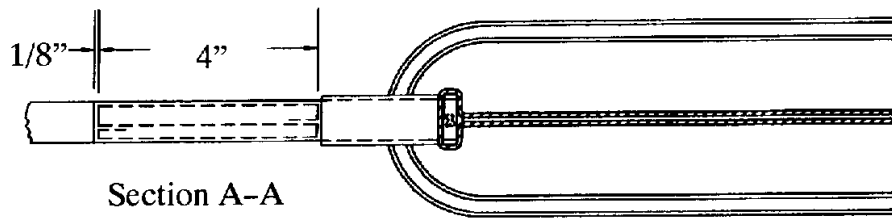
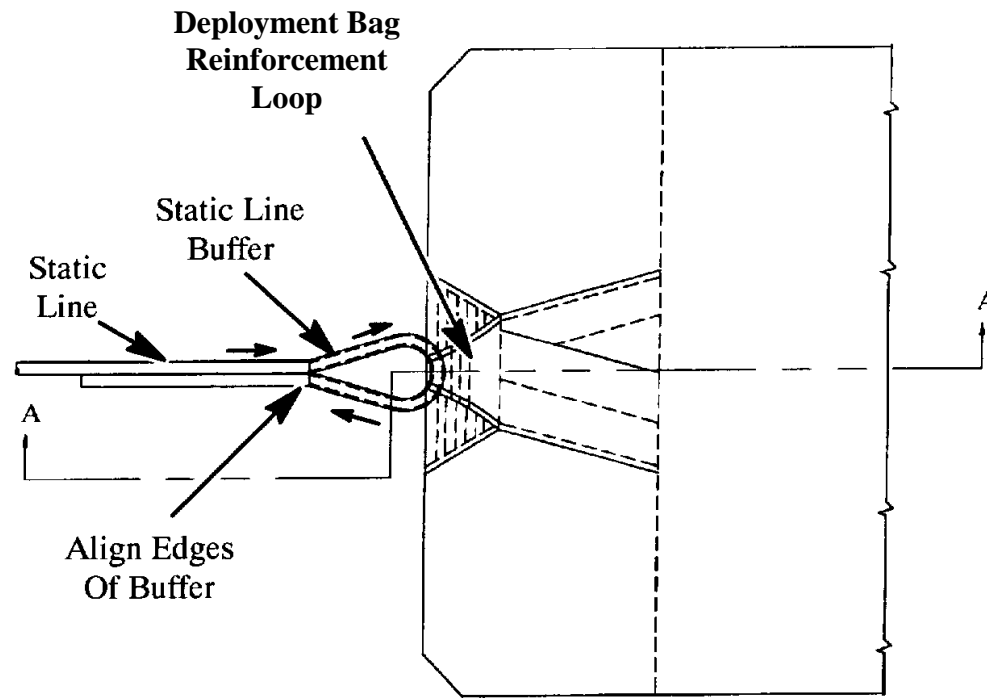

- (3) Align the two ends of the buffer and stitch the static line in place, using a heavy-duty sewing machine, size 6, nylon cord, 5 to 8 stitches per inch, and a static line stitch formation 4-inches long.

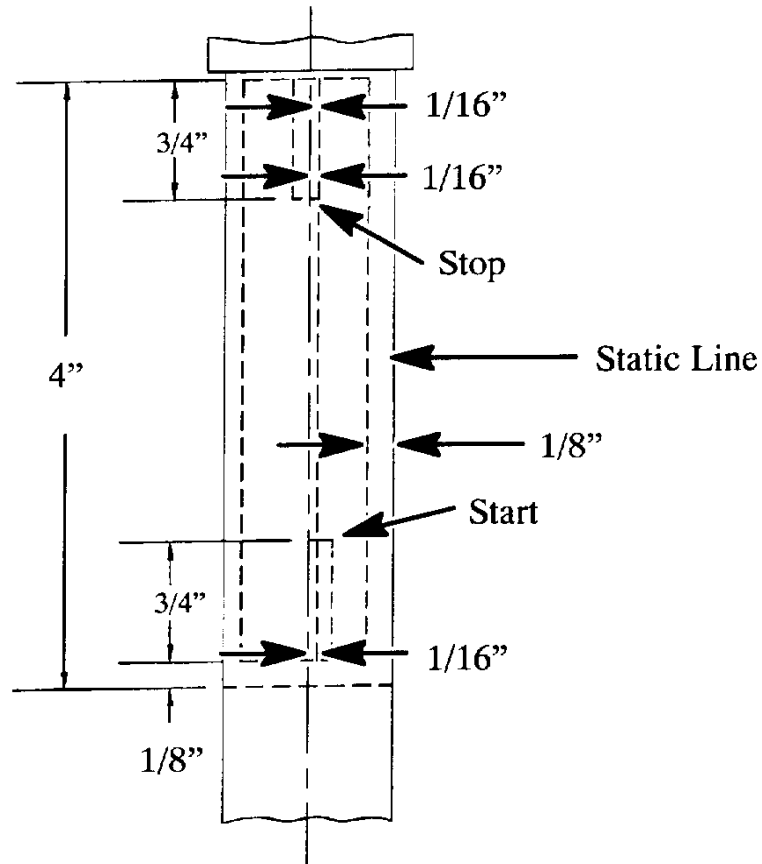

- (4) Attach a serviceable snap hook to the opposite end of the new line; make sure the fold is toward the side opposite the snap hook button.

NOTE

The folded edge of the static line will be facing outward when passing the static line through the snap hook.

- (5) Stitch the static line in place with a 4-inch static line stitch formation; use a heavy-duty sewing machine, size 6, nylon thread, and 5 to 8 stitches per inch.

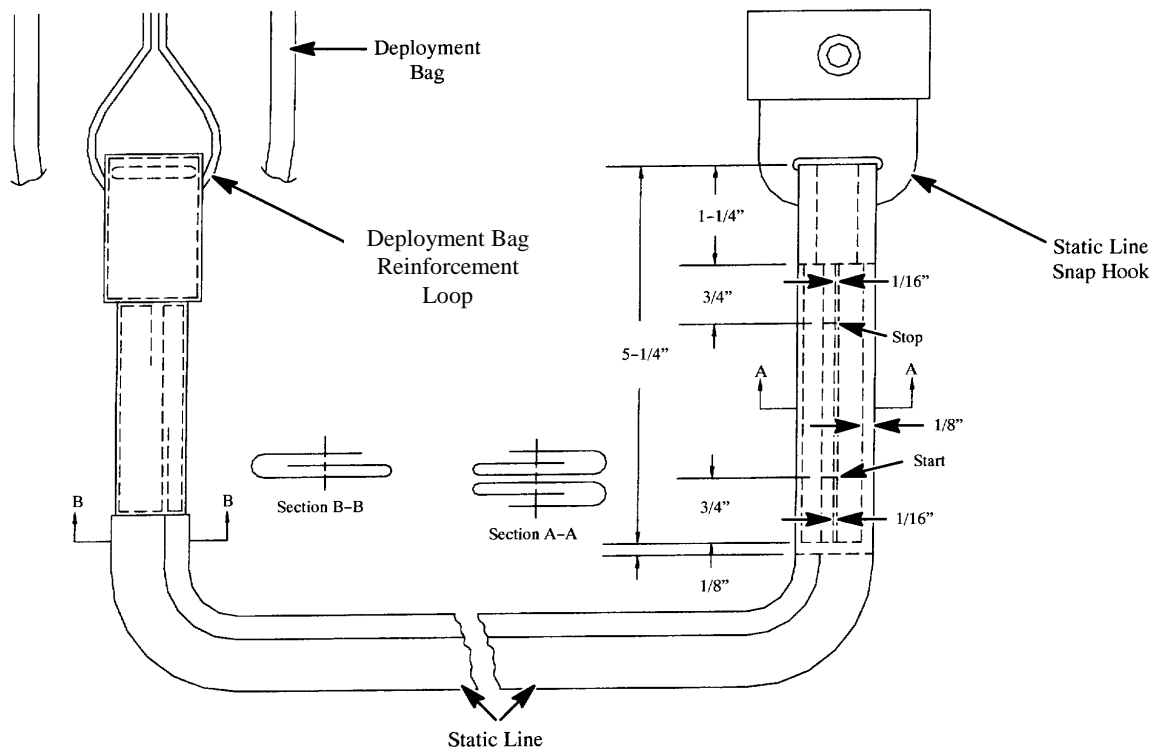

NOTE

The finished length of static line will be between 14-feet, 5 $\frac{3}{4}$ -inches and 14-feet, 9 $\frac{3}{4}$ -inches.

- (6) Fabricate and attach a new safety pin and lanyard in accordance with instructions listed in the REPAIR procedure, above.
- (7) Remove an unserviceable deployment bag and replace it with a serviceable one from stock.

11. Standard Static line extension.

- a. *Repair.* Repair the static line extension safety pin and lanyard as follows:

- (1) Remove damaged lanyard or safety pin by cutting lanyard or untying knots securing the lanyard to the static line.
- (2) Cut a 5-inch length of 0.080-inch diameter corrosion resistant steel wire and construct a new safety pin as previously shown in this WP.

(3) To prepare a new lanyard, cut a 20-inch length of type II (or type III) nylon cord. Remove the core cord, tie an overhand knot at each end, and sear both ends as described in WP 0011 00. Secure the cord to the safety pin and the static line snap hook, as shown previously in this WP.

- b. *Replace.* Remove the 5-foot-long static line extension from the 15-foot static line. Replace the damaged safety pin or the lanyard, as described in the repair procedures detailed above. If the extension is unserviceable because of frays, cuts, worn areas or other defects in the fabric that cannot be repaired by restitching, replace the extension with a serviceable item from stock.
- c. *Install.* Install the 5-foot extension onto the static line by attaching the ring, of the extension, to the snap hook of the 15-foot static line. Install and bend the safety pin. Slide the permanently attached cover, on the extension, over the snap hook of the 15-foot static line. Tie and tape in place with 2-inch masking tape.

12. Universal Static Line.

- a. *Repair.* There is no repair authorized on the USL or the USL snap hook.
- b. Remove the unserviceable portion of the USL or snap hook and replace it with a serviceable one from stock.

REPLACE

Remove an unserviceable deployment bag and replace it with a serviceable item from stock.

END OF WORK PACKAGE

THIS PAGE INTENTIONALLY LEFT BLANK

UNIT MAINTENANCE
MC1-1C/MC1-1D TROOP BACK PARACHUTE ASSEMBLY
HARNES ASSEMBLY

THIS TASK COVERS:

- Repair
 - Replace
-

INITIAL SETUP:**Equipment Condition**

Harness cleaned, and inspected with defects recorded.

Tools

Knife (Item 13, WP 0042 00)
 Sewing Machine, Light-Duty (Table 1, WP 0012 00)
 Sewing Machine, Medium-Duty (Table 1, WP 0012 00)
 Sewing Machine, Heavy-Duty (Table 1, WP 0012 00)
 Shears (Item 28, WP 0042 00)
 Tool Kit, Canopy Release (Item 31, WP 0042 00)
 Canopy Release Repair Kit (Item 3, WP 0042 00)
 Hammer, Ball Peen (Item 9, WP 0042 00)
 Tester, Spring Scale (Item 30, WP 0042 00)
 Pliers, Needle Nose (Item 23, WP 0042 00)
 Brush, Artist's (Item 2, WP 0042 00)
 Pot, Melting, Electric (Item 25, WP 0042 00)

Personnel Required

92R(10) Parachute Rigger

Materials/ Parts

Cloth, Duck, Nylon, Type III (Item 8, WP 0055 00)
 Felt, Type I, ³/₁₆-inch-thick (Item 20, WP 0055 00)
 Rubber, Cellular, ¹/₂-inch-thick (Item 33, WP 0055 00)
 Tape, Lacing, Tying (Item 38, WP 0055 00)
 Tape, Nylon, Type III, 1-inch-wide (Item 46, WP 0055 00)
 Thread, Nylon, Size E (Item 49/52, WP 0055 00)
 Thread, Nylon, Size 6 (Item 54, WP 0055 00)
 Webbing, Nylon, Type I, ⁹/₁₆-inches-wide (Item 62, WP 0055 00)
 Webbing, Nylon, Type III (Item 63, WP 0055 00)
 Webbing, Nylon, Type XIII (Item 67, WP 0055 00)
 Webbing, Elastic, 1-inch-wide (Item 56, WP 0055 00)
 Paint, Enamel, Flat, Yellow (Item 26, WP 0055 00)
 Paint, Enamel, Flat, Red (Item 71, WP 0055 00)
 Beeswax, Technical, 1-LB (Item 2, WP 0055 00)
 Wax, Paraffin, 1-LB (Item 55, WP 0055 00)

References

Group No. 04, MAC (WP 0048 00)
 WP 0014 00

REPAIR

The following repairs may be made to the harness assembly:

1. *Hand tacking.* Hand tack loose or broken tacking according to the original construction.
2. *Restencilling.* Restencil the harness as necessary, according to the instruction in WP 0014 00.
3. *Repainting canopy release.* Replace the chipped paint on the female fitting of the canopy release with red enamel paint.
4. *Restitching.* Restitch with thread that matches the size and color of the original stitching. Lock all straight stitching by back stitching at least ¹/₂-inch. Restitch directly over the original stitching; follow the original stitch pattern as closely as possible.

REPLACE

Replace components of the harness assembly in accordance with the following procedures:

1. *Elastic retainer webbing.* Replace as follows:
 - a. Cut the damaged retainer and remove from the harness.

- b. Cut a length of type I, elastic webbing, 4½-inches-long; dip the ends of the webbing ¼-inch into the melting pot.

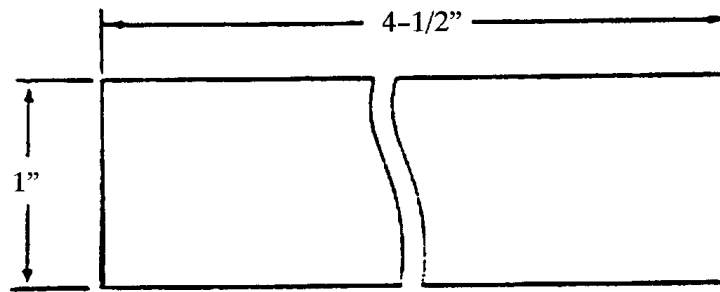

- c. Fold the webbing; align the ends and sew across the webbing ¼-inch from the aligned ends. Use a light-duty sewing machine, size E nylon thread, 7 to 11 stitches per inch.

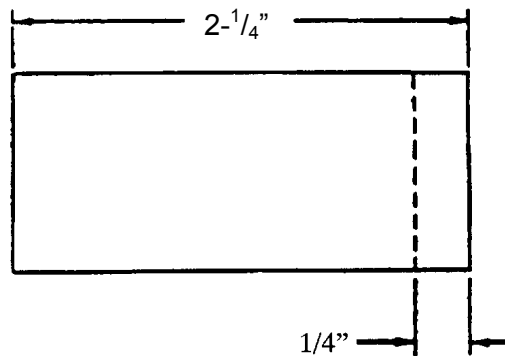

- d. Fold both ends over along the row of stitching; stitch through the ends and one layer of the loop 1/16-inch from the webbing ends. Use a light-duty sewing machine, size E nylon thread, and 7 to 11 stitches per inch.

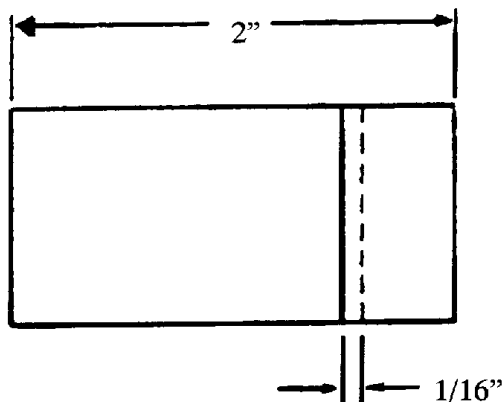

- e. Turn the loop inside-out and slide into position on the appropriate strap.

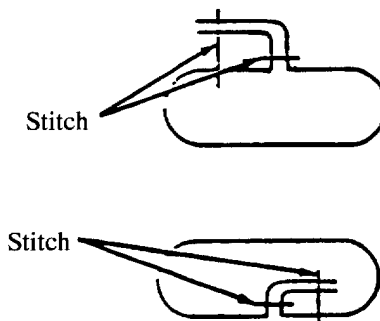

2. *Horizontal back-strap.* Replace as follows:

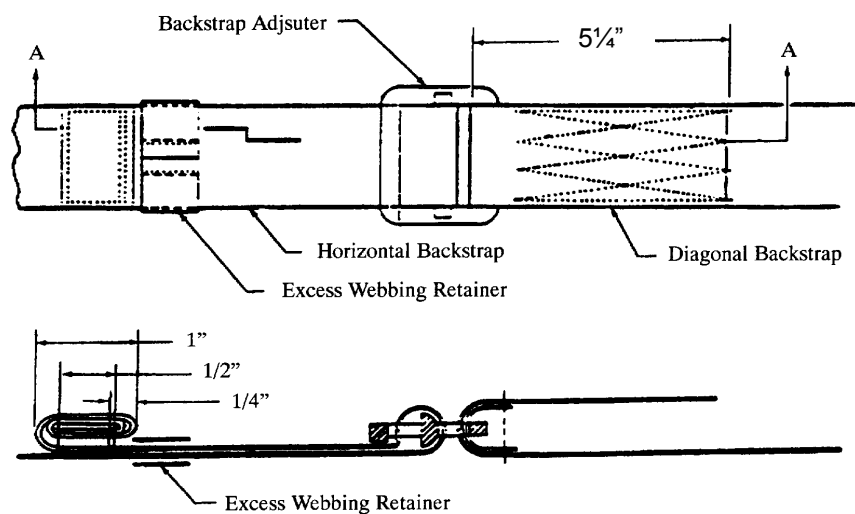

- Remove the damaged strap from the harness assembly.
- Cut an 84-inch length of type XIII nylon webbing; sear the ends.
- Slip an elastic retainer webbing over each end of the strap.
- Pass one end of the webbing through one strap adjuster, through the back-strap loops, and through the other strap adjuster.
- Roll each webbing end to form five plies. Use a heavy-duty sewing machine, size 6 nylon thread and 5 to 8 stitches per inch, to sew a box formation on the rolled webbing.

- f. Restencil, on the horizontal back-strap, the data that was on the removed horizontal back-strap: the date of harness manufacture, the date placed into service, or any other pertinent data.
3. *Canopy release pad.* Replace as follows:
- a. Cut the tacking and remove the unserviceable canopy release pad.
 - b. Cut a piece of type III, nylon duck cloth, 8½-inches-long and 5³/₈-inches-wide.

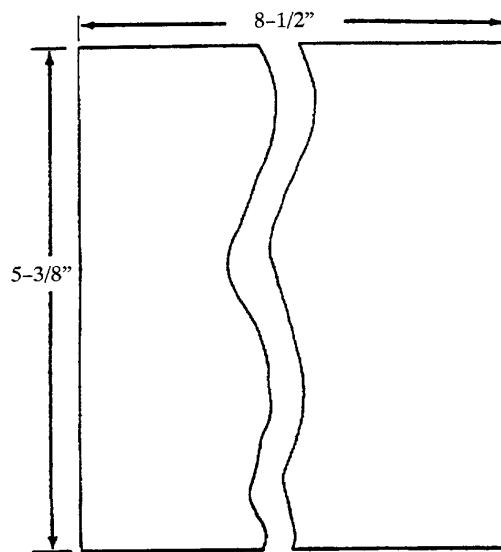

- c. Fold the cloth in half; align the 5³/₈-inch side, and stitch ½-inch from the edge on the 5³/₈-inch side, and one of the 4¼-inch sides. Use a light-duty sewing machine, size E nylon thread, and 7 to 11 stitches per inch.

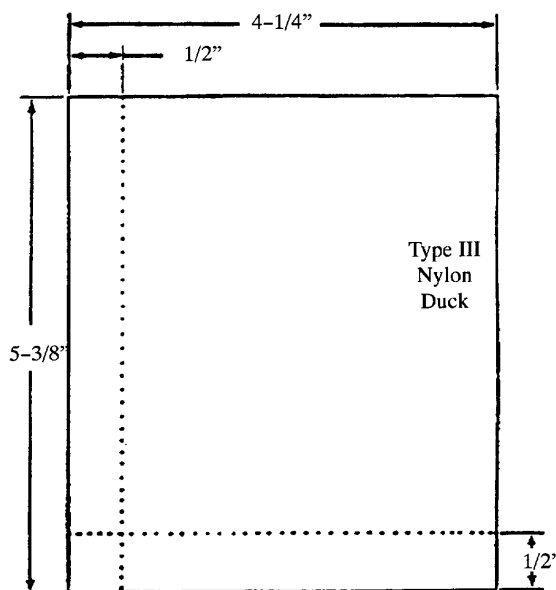

- d. Turn the sleeve inside-out.
- e. Cut a $4\frac{7}{8}$ - by $3\frac{3}{4}$ -inch piece of $\frac{1}{2}$ -inch thick cellular rubber; insert it in the nylon duck sleeve.

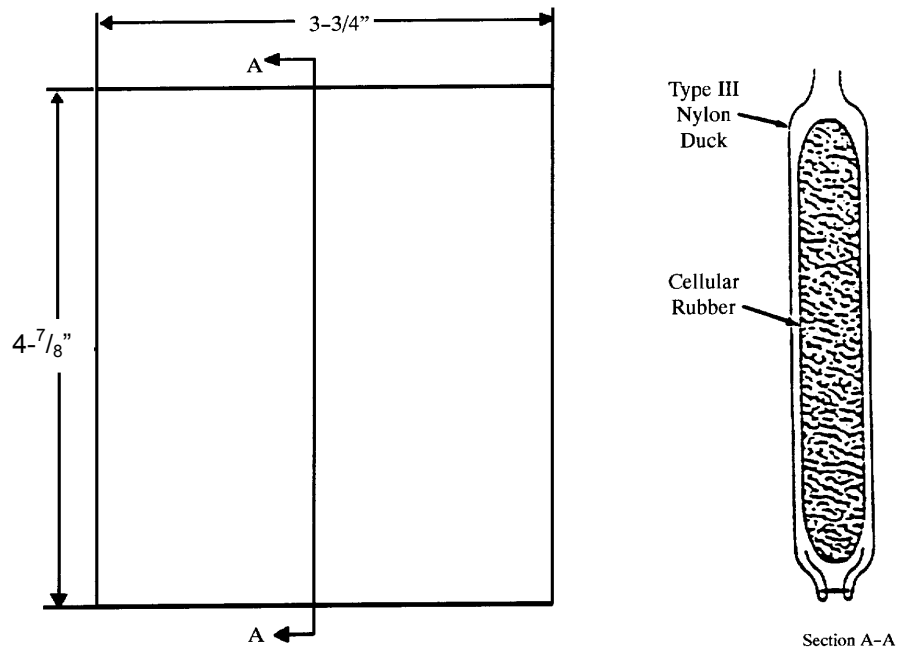

- f. Tuck in the raw edges, at the ends of the sleeve, $\frac{1}{2}$ -inch; stitch across each end of the sleeve $\frac{1}{8}$ -inch from the edge. Use a light-duty sewing machine, size E nylon thread, and 7 to 11 stitches per inch.

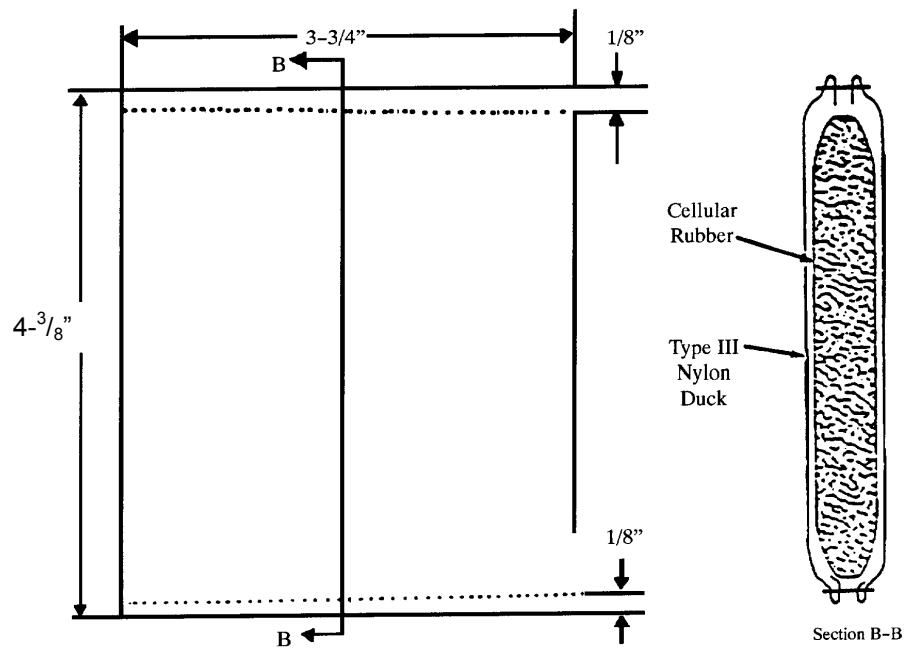

- g. Cut a 6 $\frac{3}{4}$ -inch length of $\frac{9}{16}$ -inch type I, nylon webbing; sear the ends.
- h. Center the webbing across the pad $\frac{3}{4}$ -inch from one end; stitch in place with a single-X box-stitch formation, with a double row of stitching at both ends. Use a light-duty sewing machine, size E nylon thread, and 7 to 11 stitches per inch.

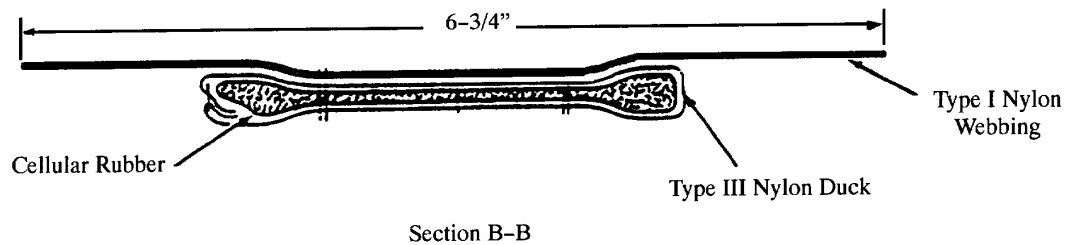
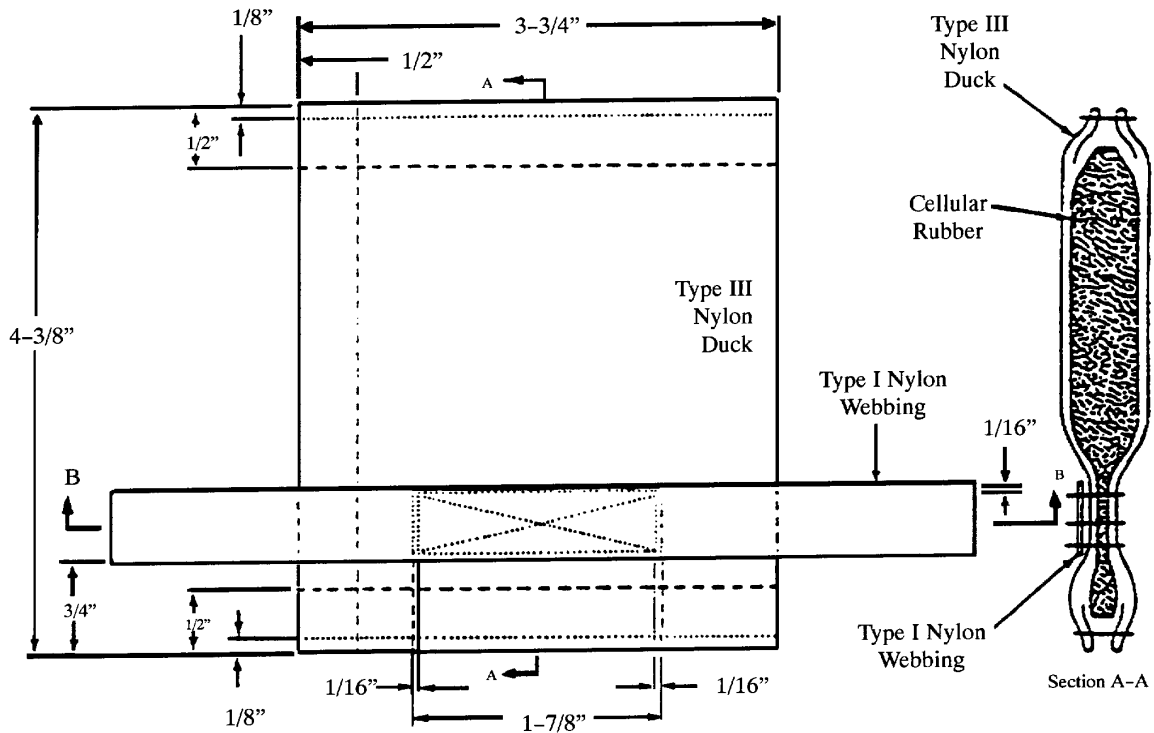

- i. Position the pad under the canopy release as shown.

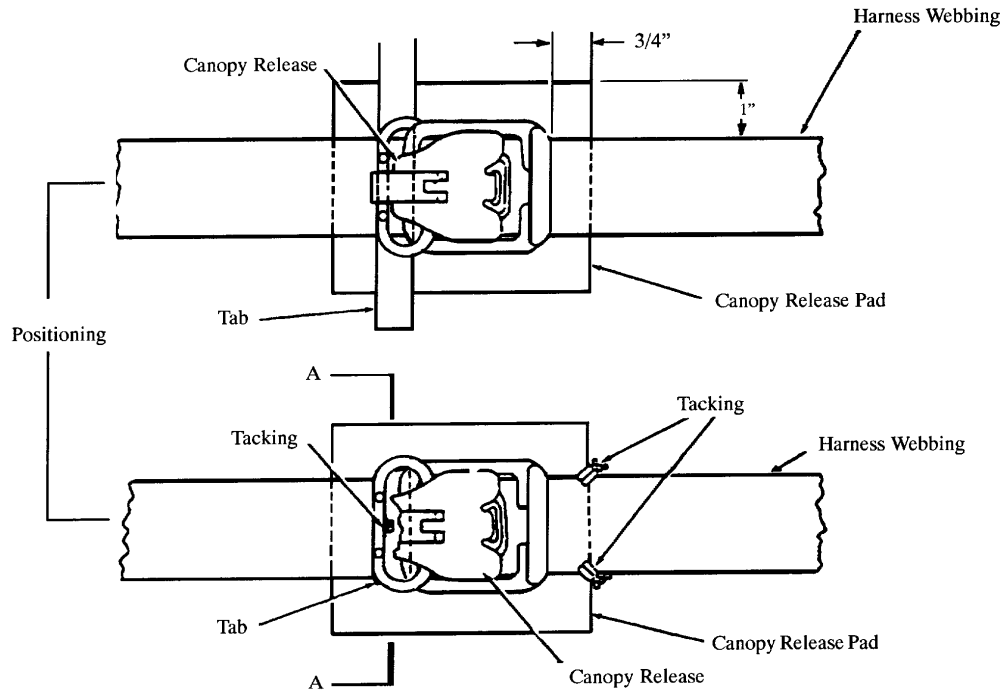

- j. Fold the tab around the harness webbing; hand tack the ends of the tab together with two-turns of doubled and waxed tape, lacing and tying.

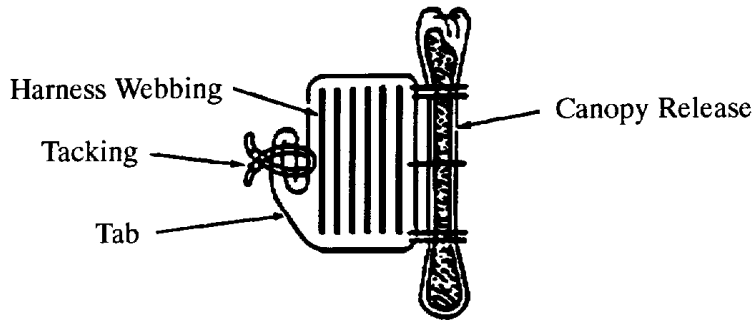

- k. Tie the ends of the lacing with a surgeon's knot and locking knot.

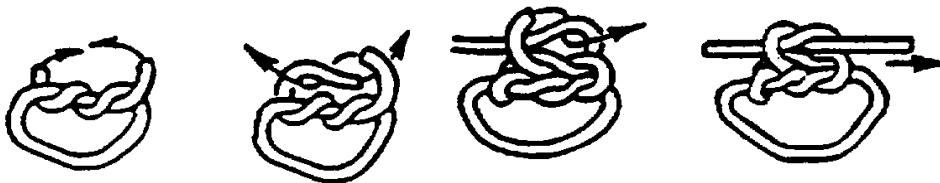

- I. Hand tack the opposite end of the pad to the harness webbing, in two places, with two-turns of doubled and waxed tape, lacing and tying.

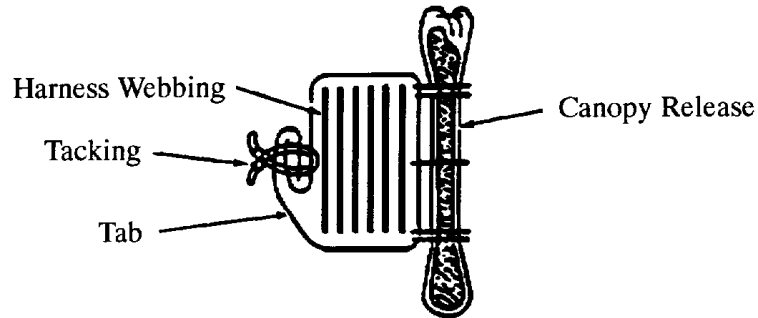

- m. Tie the ends of the lacing with a surgeon's knot and a locking knot.

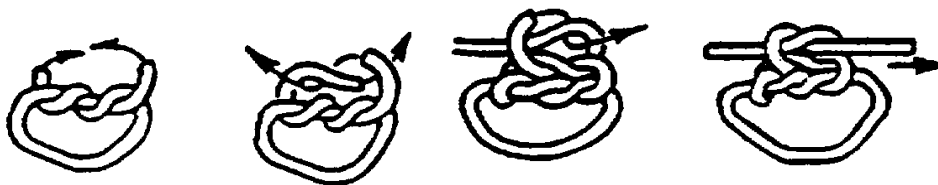

4. *Ejector snap pad.* Replace as follows:

- a. Cut the tacking and remove the damaged ejector snap pad.
- b. Cut a piece of type I, $\frac{3}{16}$ -inch-thick felt, 6-inches-long and 4-inches-wide; round all the corners on a $\frac{1}{4}$ -inch radius.

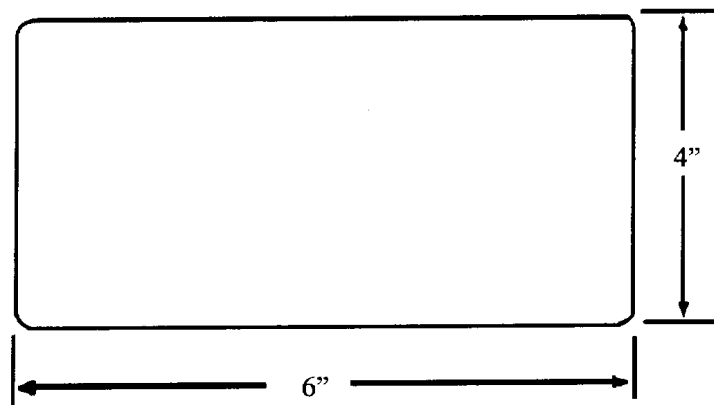

- c. Cut two pieces of olive green, type III, nylon cloth, 6-inches-long and 4-inches-wide. Round all the corners on a $\frac{1}{4}$ -inch radius.

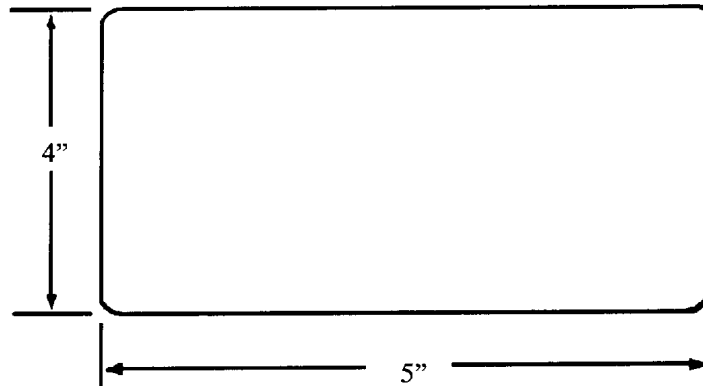

Type III Nylon Cloth

- d. Cut a piece of type III, 1-inch-wide, olive drab (OD) nylon tape, 21-inches-long. Sear both ends.
- e. Place the piece of felt between the two pieces of nylon cloth so that all the edges are even. Make a temporary hand tack at the center of the pad, 1-inch in from each end.

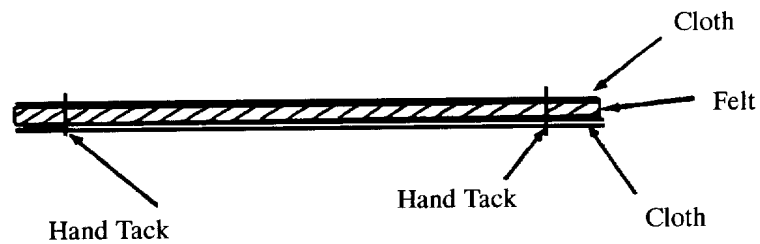
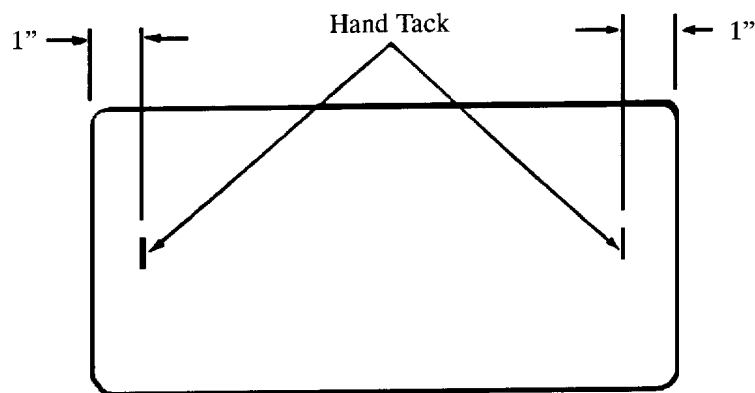

- f. Beginning at the center of one end, bind the replacement pad with the length of tape cut in step d., above. Sew the tape to the pad with two rows of stitching, using OD, size E, nylon thread, and 7 to 11 stitches per inch. Sew one row $\frac{1}{8}$ -inch in from the outer edge of the pad, and one row $\frac{3}{32}$ -inches in from the inside edge of the tape. The running end of the tape will overlap approximately 1-inch.

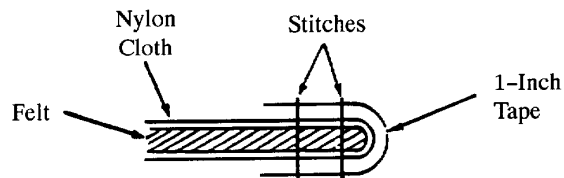
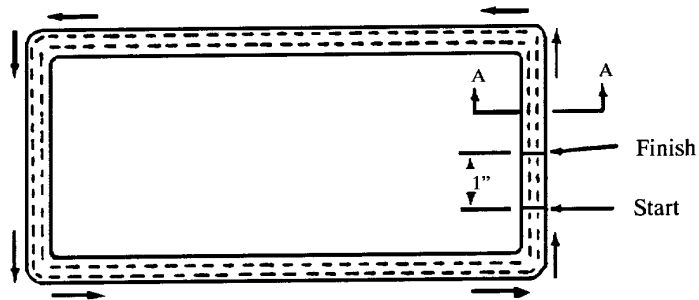

Section A-A

- g. Tack the replacement pad to the snap pad in two places, with two turns of doubled and waxed, tape, lacing and tying. Secure the ties on the inside of the pad with a surgeon's knot and a locking knot. Trim the lacing to 1-inch.

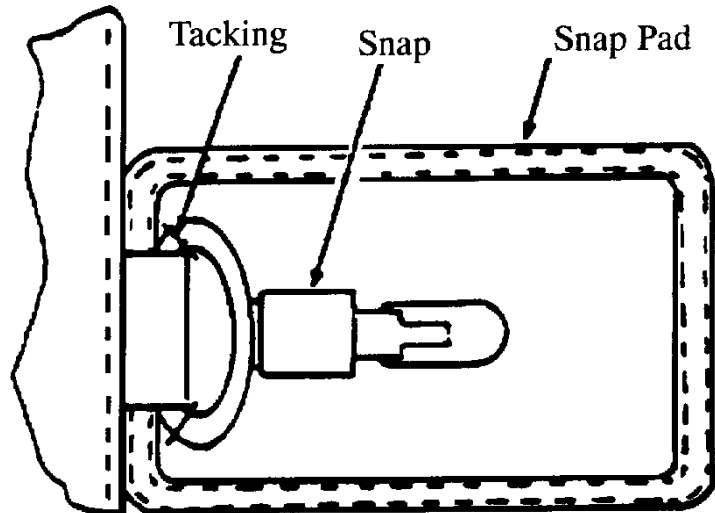

5. *Canopy release actuator, slide, assembly pin and lever assemblies.* Replace as follows:

NOTE

Tool kit, Capewell or equal, will be used to disassemble the release and install the replacement parts. Fasten to the edge of work surface with screws furnished.

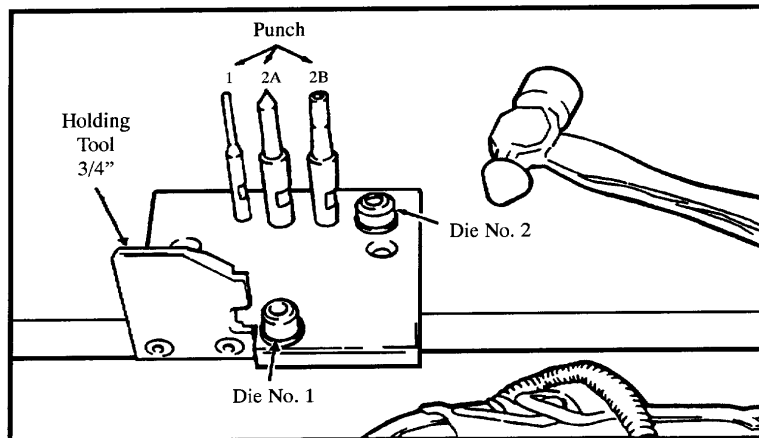

- a. Install the female fitting on the holding tool and secure by closing the actuator and lever assembly. Ensure the head of the assembly pin is seated in the No. 1 die fitting.

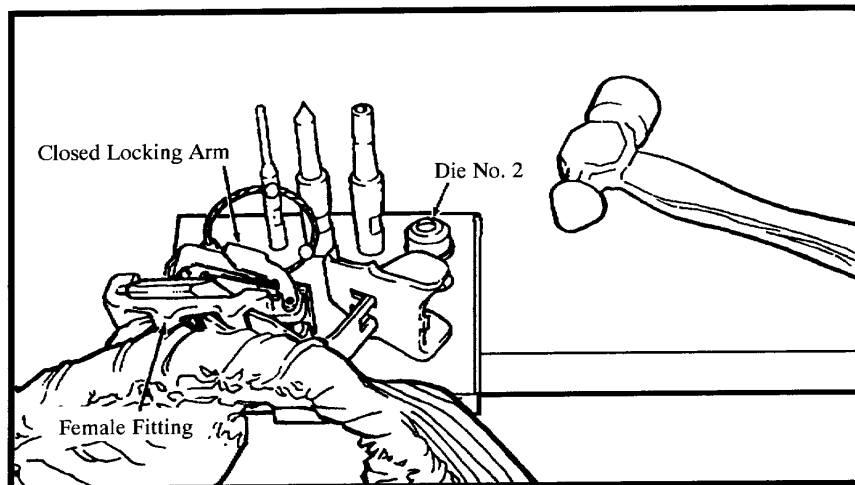

- b. Center the No. 1 disassembly punch on the rolled end of the assembly pin. Strike several blows with an 8- to 12-ounce hammer to break off the riveted head of the pin. Drive out the assembly pin.

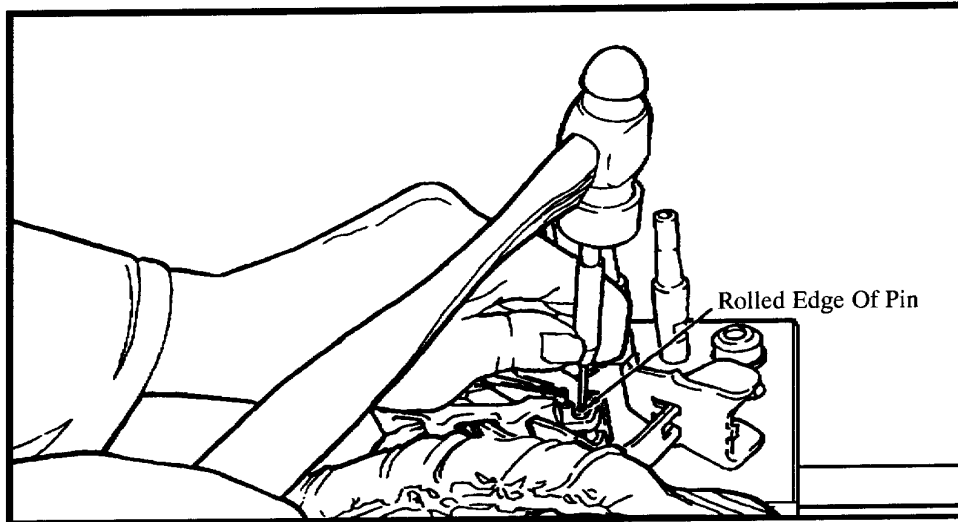

- c. Keeping all components intact, remove female fitting from holder and place harness on a packing table or other suitable surface with canopy release assembly facing up.
- d. Remove assembly pin and safety clip (cover).
- e. Retract slide and remove the actuator and lever assembly from the female fitting ensuring the slide lip is placed as shown.

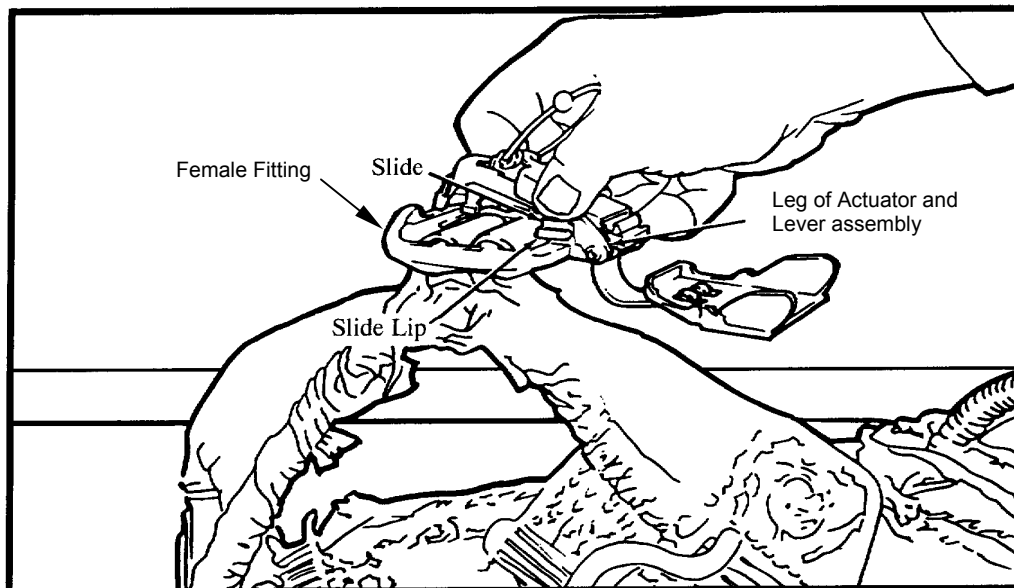

- f. Remove the slide.

6. Assemble as follows:

- a. If the actuator and the lever are not assembled, insert the triangular tongue of the actuator into the slot in the top of the lever.

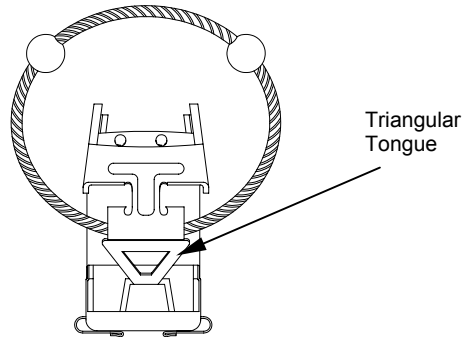

- b. Position the triangular hole over both bent ears of the lever by moving the triangle forward. Holes of the actuator legs will fall in approximate alignment with the lever.

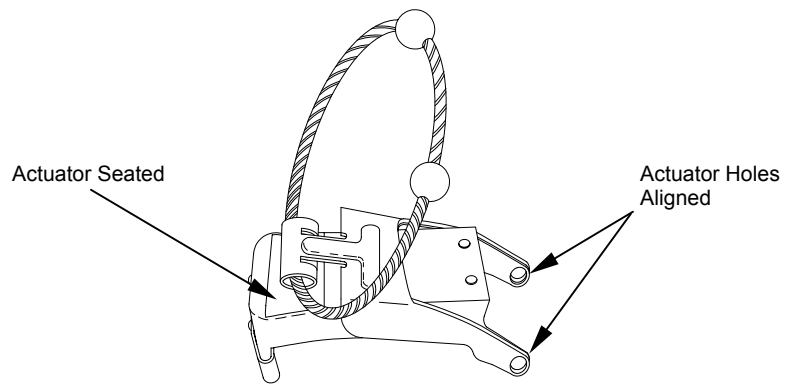

- c. Reposition new slide on the female fitting.

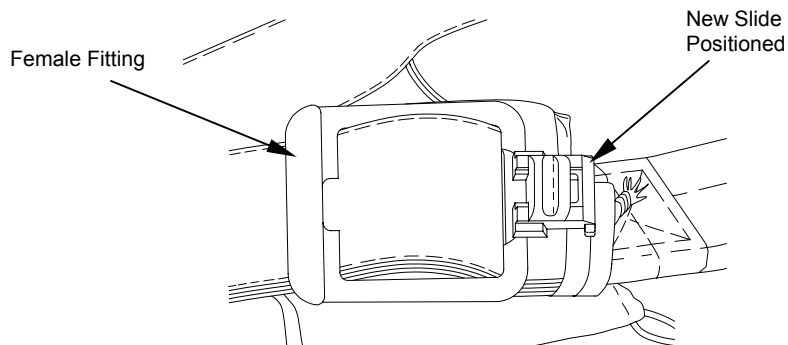

NOTE

The slide must be retracted slightly to permit the legs of the lever to straddle slide forward of the slide ears.

- d. Position the assembled actuator and lever assembly on the female fitting and align the assembly pinholes with the female fitting assembly holes.
- e. Insert the assembly pin through one leg of the actuator and lever pinholes. The assembly pin is inserted so the pinhead is in the down position when the assembly is mounted on the holding tool.
- f. Position the safety clip (cover) engaging hinge between the shoulder on the underside of the female fitting. Push the assembly pin through the hinge and the opposite leg holes. All parts are now engaged and pivoting on the assembly.
- g. Replace die No.1 with die No. 2; re-engage the female fitting onto the holder.
- h. Insert the washer on the assembly pin.
- i. Using punch 2A, flare pin end by applying light taps with a hammer.
- j. Using punch 2B, roll the end of the pin by applying light taps with a hammer.

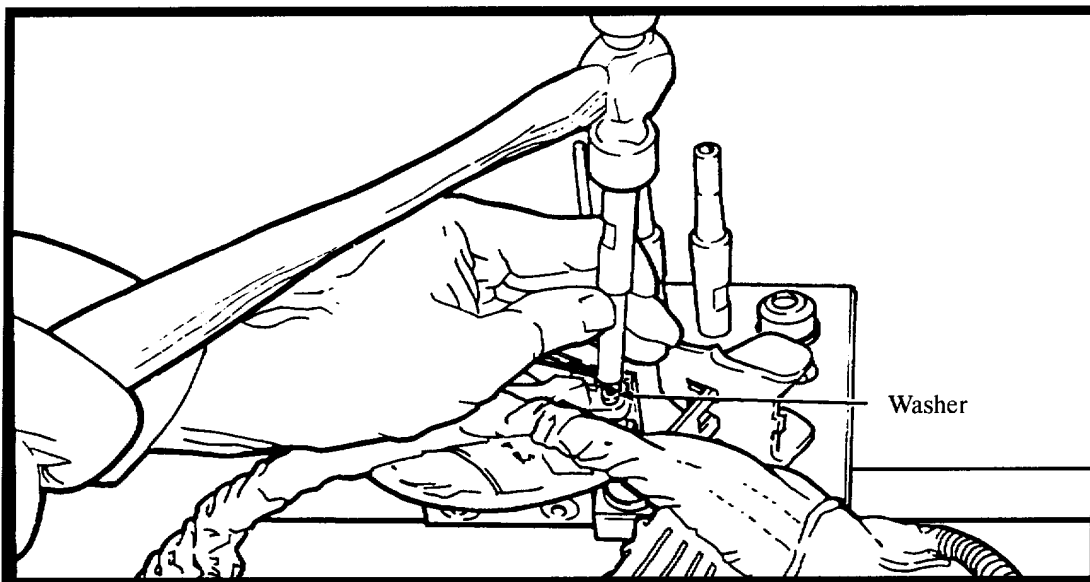

- k. Remove the assembly from the holding tool and check to assure the lever rotates freely.

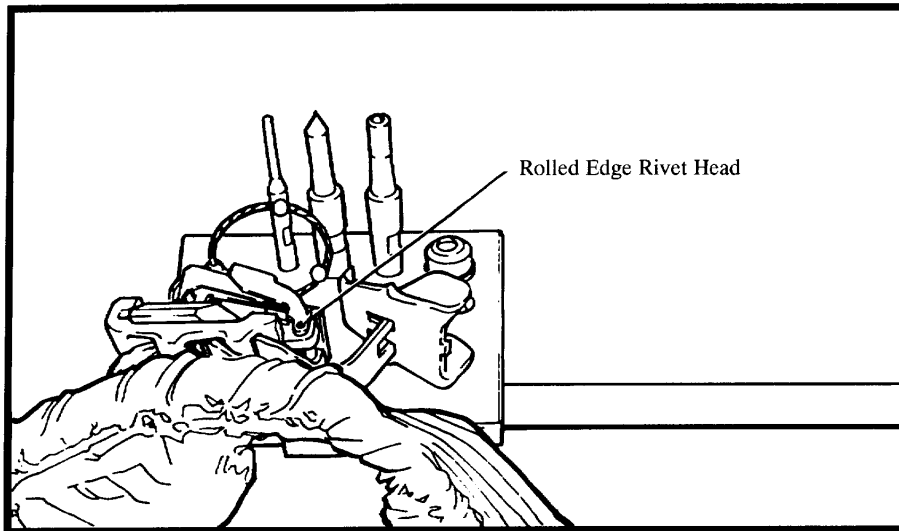

7. *Canopy release cable loop repair.* Repair as follows:

NOTE

A maximum of six strands may be broken and removed.

- a. Using small needle nose pliers, unwind the broken wire strand off the cord, to the point where it meets the swaging, by twisting and turning the wire strand until it breaks off.
- b. Repeat this procedure with the other end of the wire strand where it meets the latch assembly.
- c. Using a small paintbrush, mark the cable at a point next to the latch assembly with yellow paint.

NOTE

Once a cable is marked as repaired, it will no longer be eligible for further repairs and must be replaced.

END OF WORK PACKAGE

THIS PAGE INTENTIONALLY LEFT BLANK

UNIT MAINTENANCE
MC1-1C/MC1-1D TROOP BACK PARACHUTE ASSEMBLY
PACK TRAY

THIS TASK COVERS:

- Repair
 - Replace
-

INITIAL SETUP:**Equipment Condition**

Pack tray cleaned with all defects recorded.

Tools

Anvil, Chuck Fastener (Item 1, WP 0042 00)
 Chuck (Item 4, WP 0042 00)
 Cutter, Double-Bow, ½-inch (Item 5, WP 0042 00)
 Cutter, Single-Bow (Item 6, WP 0042 00)
 Die (Item 7, WP 0042 00)
 Holder, Die, Fastener (Item 10, WP 0042 00)
 Knife, Hot Metal (Item 14, WP 0042 00)
 Knife (Item 13, WP 0042 00)
 Lead, Pig, 5-lbs. (Item 15, WP 0042 00)
 Mallet, Rawhide (Item 17, WP 0042 00)
 Press, Hand Operated (Item 25, WP 0042 00)
 Pot, Melting (Item 24, WP 0042 00)
 Sewing Machine, Darning (Table 1, WP 0012 00)
 Sewing Machine, Light-Duty (Table 1, WP 0012 00)
 Sewing Machine, Medium-Duty (Table 1, WP 0012 00)
 Sewing Machine, Heavy-Duty (Table 1, WP 0012 00)
 Sewing Machine, Zig-Zag (Table 1, WP 0012 00)
 Shears (Item 28, WP 0042 00)

Personnel Required

92R(10) Parachute Rigger

Materials/ Parts

Beeswax (Item 2, WP 0055 00)
 Cloth, Duck, Nylon Type III (Item 8, WP 0055 00)
 Fastener:
 Cap (Item 5, WP 0055 00)
 Post (Item 30, WP 0055 00)
 Socket (Item 34, WP 0055 00)
 Stud (Item 36, WP 0055 00)
 Tape, Lacing and Tying (Item 38, WP 0055 00)
 Tape, Nylon Type III, ¾-inch (Item 44, WP 0055 00)
 Tape, Nylon, Type III, 1¼-inch (Item 45, WP 0055 00)
 Thread, Nylon, Size E (Item 49/52, WP 0055 00)
 Thread, Nylon, Size 3 (Item 50/53, WP 0055 00)
 Wax, Paraffin (Item 55, WP 0055 00)
 Webbing, Elastic, Cotton (Item 56, WP 0055 00)
 Webbing, Nylon, Type IV (Item 70, WP 0055 00)
 Webbing, Nylon, Type VI (Item 64, WP 0055 00)
 Webbing, Nylon, Type VIII (Item 65, WP 0055 00)
 Webbing, Nylon, Type XVII (Item 68, WP 0055 00)

References

Group No. 05, MAC (WP 0049 00)
 WP 0012 00 and WP 0042 00

REPAIR

Minor repairs to the pack tray of the MC1-1C/MC1-1D parachute consist of darning small holes (or tears), and splicing edge binding.

1. *Darning.* There is no limit to the number of times the pack tray may be darned. Darn small holes or tears that do not exceed ¾-inch in length or diameter; adapt procedure for darning from WP 0012 00.
2. *Splicing edge binding.* Splice as follows:
 - a. Cut a piece of type III nylon tape, long enough to extend 1-inch beyond each end of the damage.

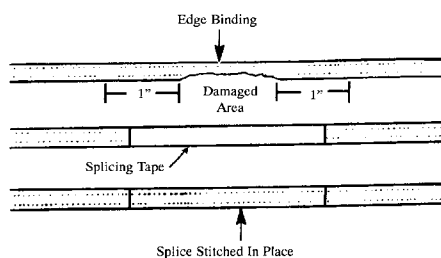

- b. Fold-under each end ¼-inch; center the binding over the damaged area, and stitch into place using a medium-duty sewing machine, size E nylon thread, and 7 to 11 stitches per inch. Overstitch the ends of the splice at least ½-inch.

REPLACE

Replace the components of the pack tray as follows:

1. *Pack tray.* Remove the unserviceable pack tray and replace it with a new one from stock, as follows:
 - a. Unsnap the diagonal and horizontal back-strap retainers and remove the pack tray.
 - b. Place the harness on the new pack tray. Place the diagonal and horizontal back-strap retainers over the back-strap; snap the retainers.

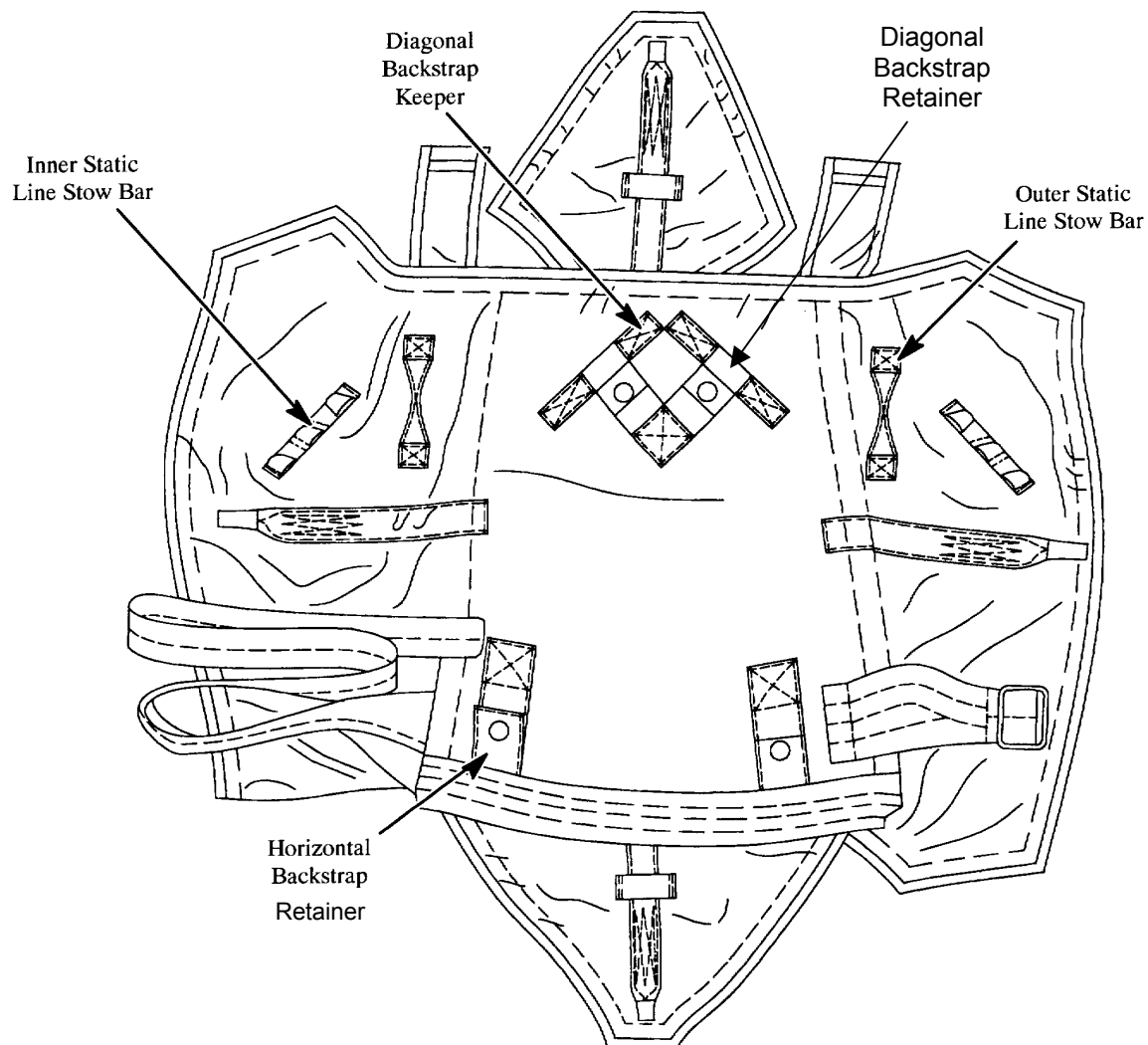

2. *Back-strap keepers*. Replace as follows:

- a. Cut the stitching; remove the damaged horizontal back-strap keeper and loose threads.
- b. Cut an 11½-inch length of type XVII nylon webbing for the horizontal back-strap keeper.
- c. Position the new horizontal back-strap keeper 1³/₈-inches above the binding tape; align both edges even with the stitches on each side.

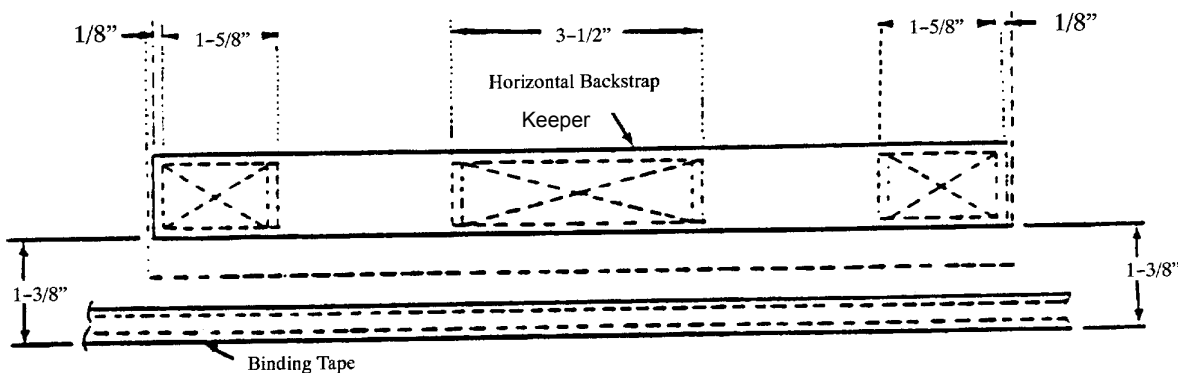

- d. Sew the horizontal back-strap keeper in place using a heavy-duty sewing machine, size 3 nylon thread, and 5 to 8 stitches per inch, with two 1⁵/₈-inch and one 3½-inch box-X-stitch formation, with a double row on each end.
- e. Cut the stitching; remove the damaged diagonal back-strap keeper and the loose threads.
- f. Cut a 6-inch length of type XVIII nylon webbing for each diagonal back-strap keeper to be replaced.
- g. Position the diagonal back-strap keeper, as shown below, and sew in place. Use a heavy-duty sewing machine, size 3 nylon thread and 5 to 8 stitches per inch, with a 1⁵/₈-inch box-X-stitch formation.

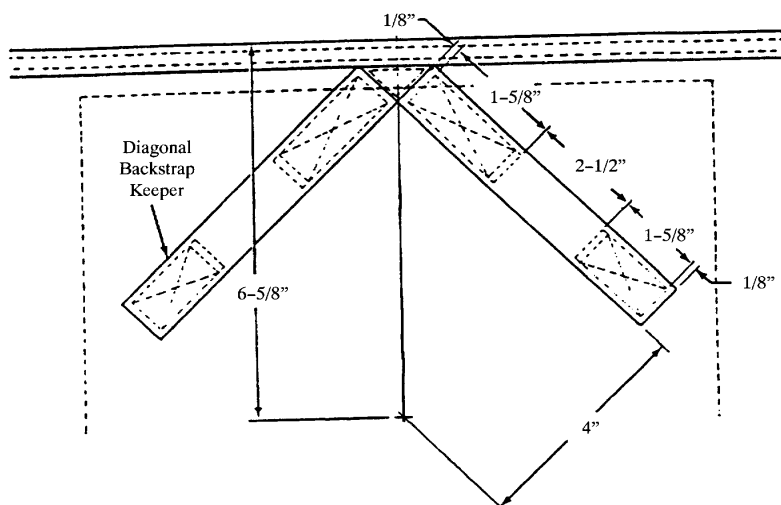

3. *Back-strap retainers.* Replace as follows:

- a. Cut the stitching; remove the damaged keeper and the loose threads.
- b. Cut an 8 ¼-inch length of type VI nylon webbing; sear the ends of the webbing.

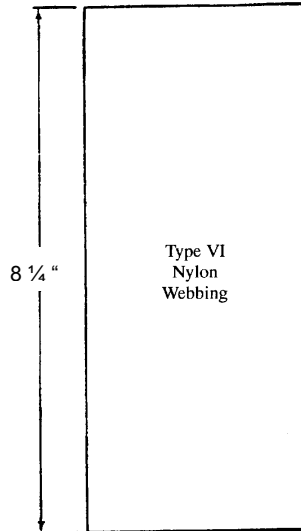

- c. Fold-under one end, 1-inch; sew with a box-X-stitch formation. Use a heavy-duty sewing machine, size 3 nylon thread, and 5 to 8 stitches per inch.
- d. Measure 2¾-inches from the seared end of the webbing, and place a 1¾-inch square piece of type III nylon duck on the opposite side of the webbing from the folded end.

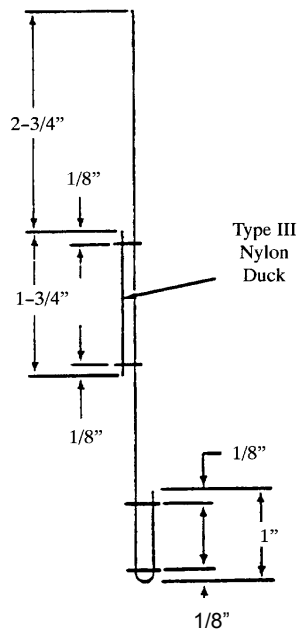

- e. Sew the duck in place; use a heavy-duty sewing machine, size 3 nylon thread, and 5 to 8 stitches per inch.
- f. Install a socket assembly in the center of the folded end, and a stud assembly in the center of the reinforcement duck, as shown below. Use the following installation procedures:

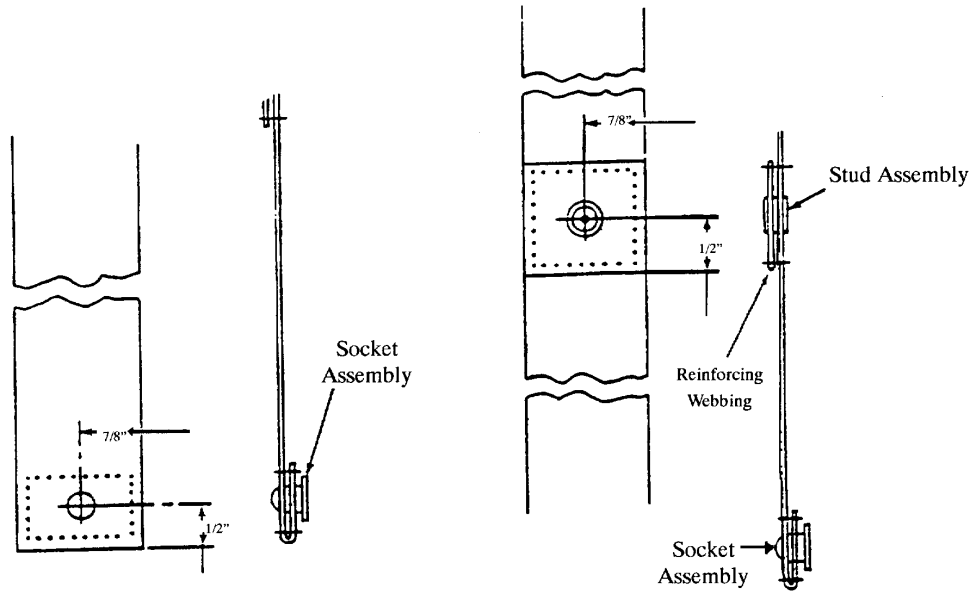

- (1) Cut the fabric for the socket and stud assemblies; use a mallet and lead cutter block, and an appropriate sized double- or single-bow cutter.

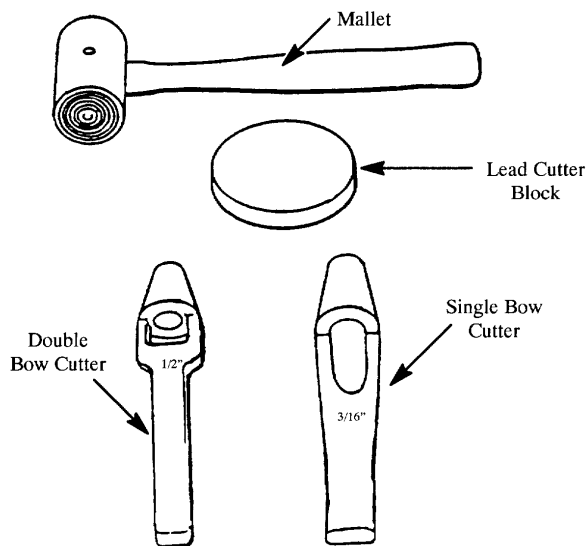

- (2) Installation of a snap fastener may be performed by three different methods. The most common method is the hand-held method that requires the use of a leather or other non-steel impact device; a holder to hold the appropriate sized chuck; and an anvil, which is used to contain a compatible sized die.

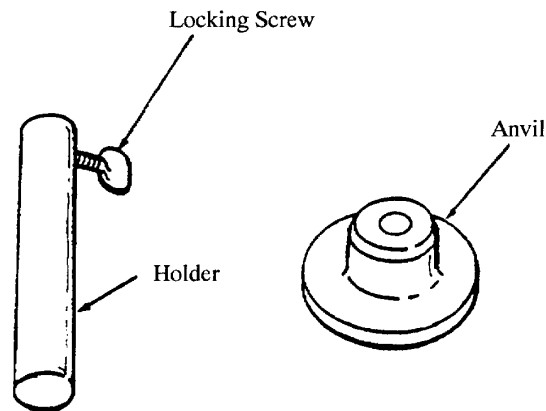

Tools Used With Hand-Held Method

- (3) A second method of installing a snap fastener assembly is by use of the hand-operated press. The hand-operated press is a lever-type device that can accommodate an appropriate sized chuck and die. When installed in the hand-operated press, the chuck and die are individually secured in position by a threaded screw that is tightened using a suitable sized key (Allen-type hexagon wrench) or a flat-tip (common-head) screwdriver, as applicable. The third method of snap fastener installation is by use of the foot-operated press which, except for the means of operation, functions similar to the hand-operated press.

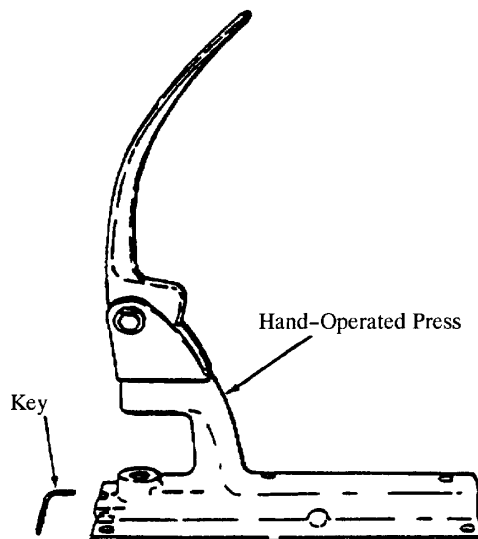

Hand-Operated Press With Key

- (4) Using the specifics in WP0042 00 (the MAC), ascertain the size die and chuck required for installing the fastener cap and socket, or stud and post, as applicable.
- (5) Place the selected chuck in the open end of the holder and secure the chuck in place; use the locking screw located on the one side of the holder. Place the appropriate die into the anvil.
- (6) Fit the socket or stud, as applicable, on the chuck lower end. Place the cap or post, as applicable, on the die with the barrel facing up.

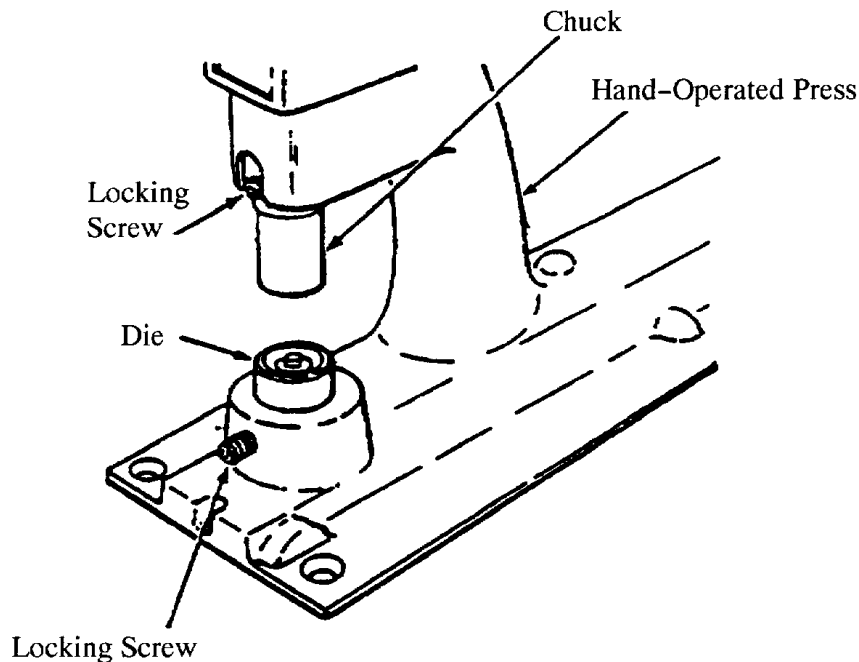

- (7) Position the material over the barrel of the cap or post. Ensure that the fastener socket or stud will be located on the proper side of the material for subsequent fastener engagement.
- (8) Place the socket or stud, on the barrel of the cap or post. With an applied strike from a mallet, clinch the two snap fastener components to the material.
- (9) Remove the clinched snap fastener components from the chuck and die set; check the seating of the joined components. If the applicable components are not properly seated, repeat the procedure from step (8), above.
- (10) Check the engagement of the installed snap fastener components with the opposite mating components; ensure the open and closed snapping process is accomplished without hindrance. If the snap engaging process cannot be accomplished without difficulty, replace the opposite mating snap fastener components using the procedures in steps (4) through (9), above.
- (11) As required, remove the chuck and die from the applicable snap fastener tools by reversing the procedure in step (5), above.

- (12) Installation of the snap fastener assemblies, by hand- or foot-operated press, can be accomplished using the procedures above, except the chuck and die will be secured within the applicable press assembly, using the available locking screws.

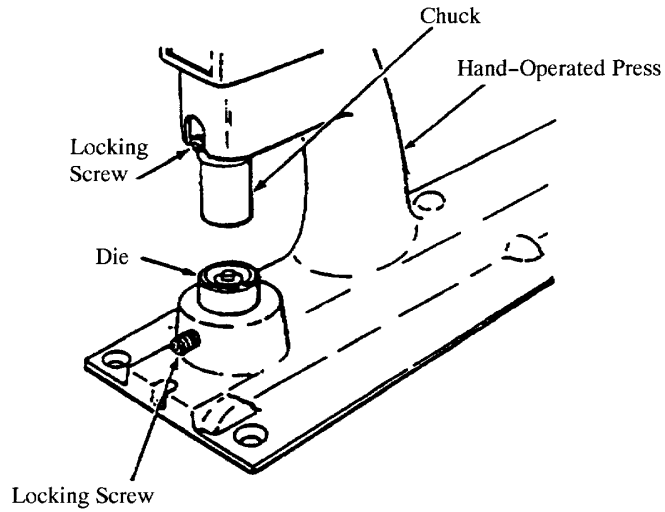

(A) Chuck And Die Installed In Hand-Operated Press

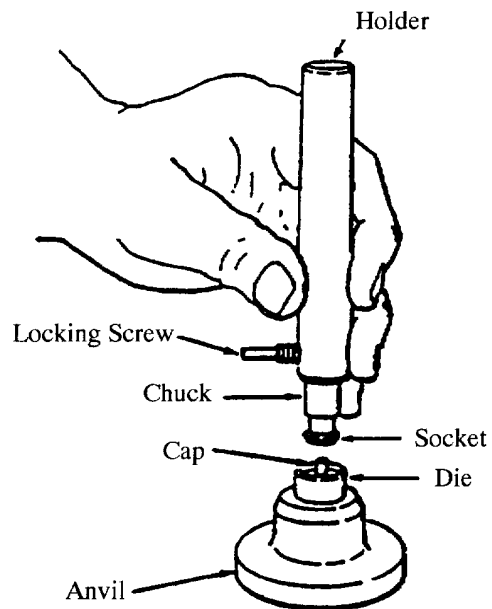

(B) Hand-Held Tools With Snap Fastener Components Prepared For Use

- g. Position the new diagonal back-strap retainers as shown in A and B, below; sew in place using a heavy-duty sewing machine, size 3 nylon thread, 5 to 8 stitches per inch, and a box-X-stitch formation.

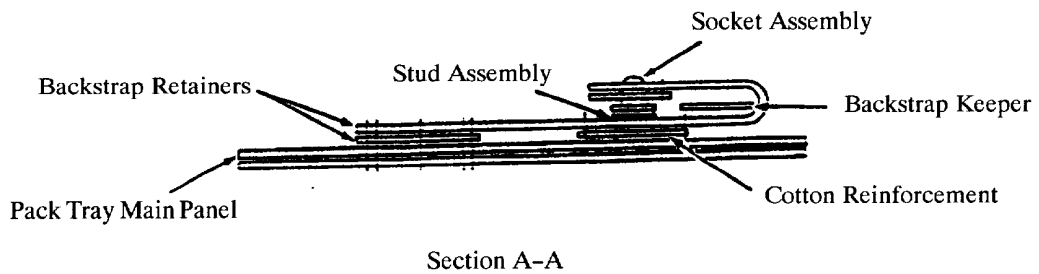
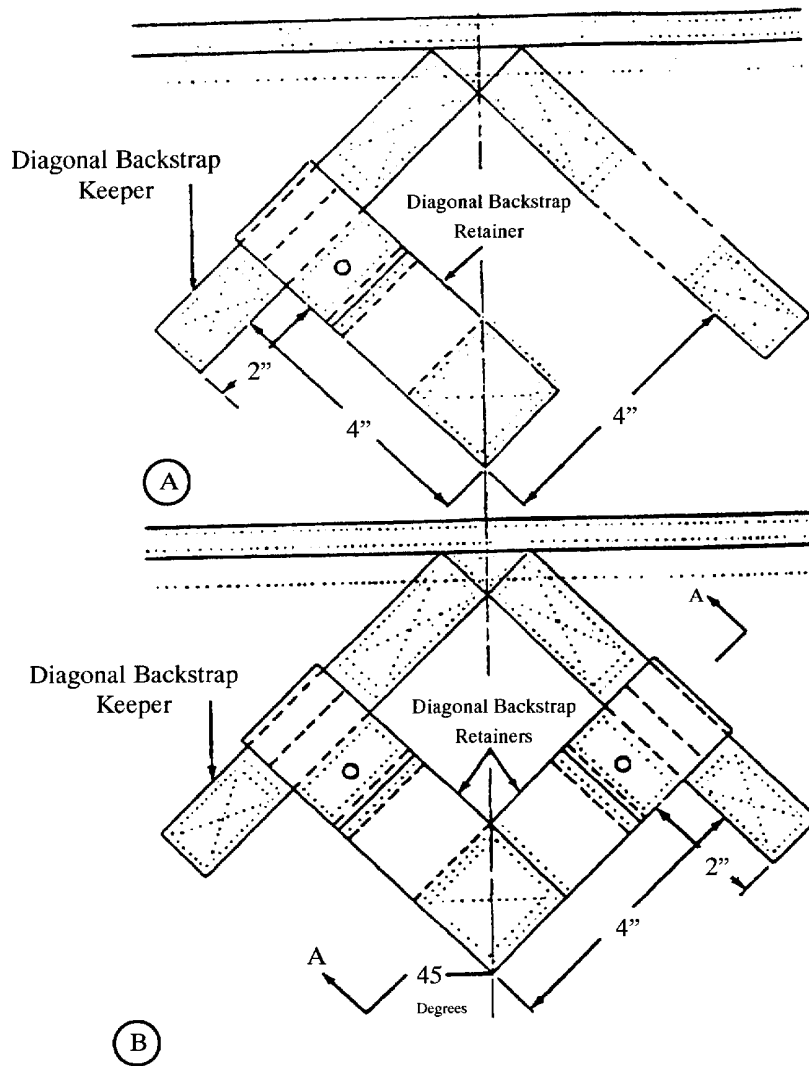

- h. Position a new horizontal back-strap retainer as shown in the illustration detailed below. Sew the retainer in place using a heavy-duty sewing machine, size 3, nylon thread, 5 to 8 stitches per inch, and a box-X-stitch formation.

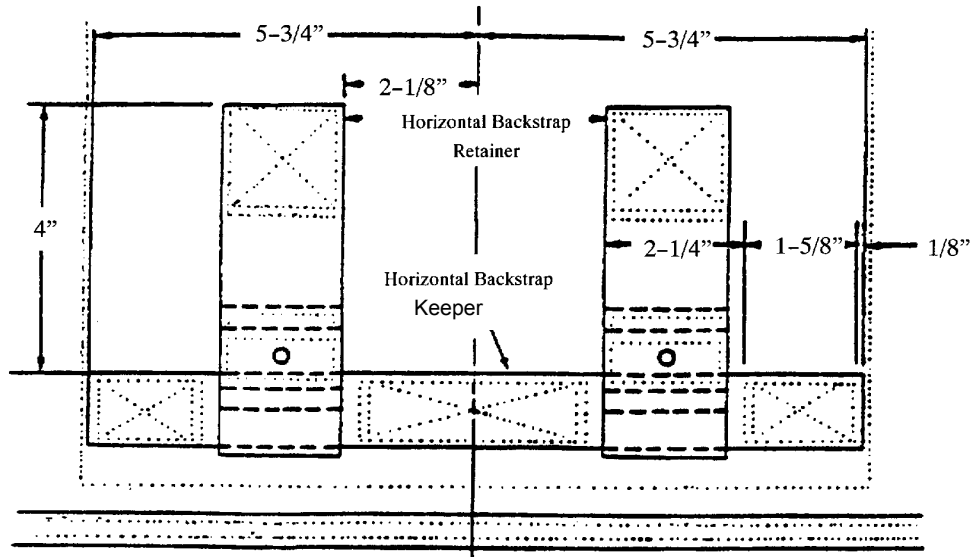

4. *Pack closing loop.* Replace as follows:

- a. Cut the damaged loop at the first row of stitching securing the loop to the pack tray.

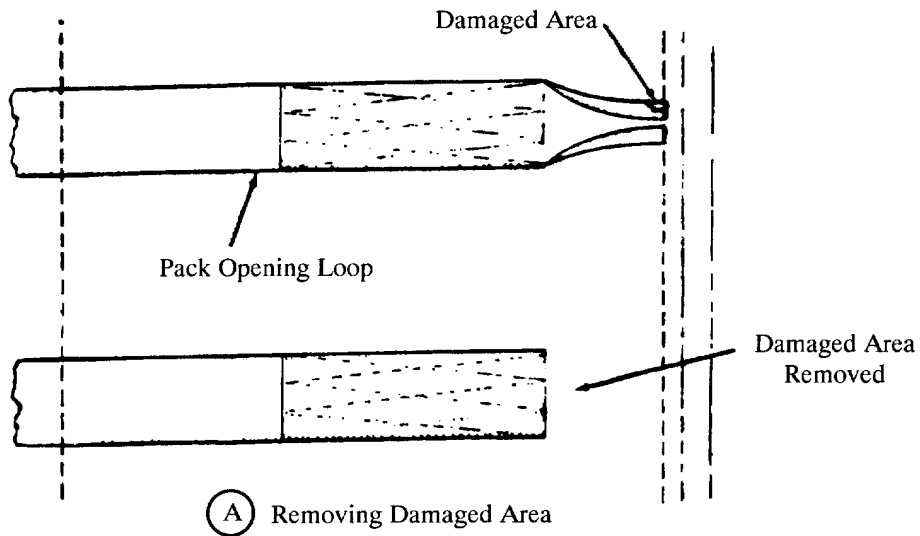

- b. Cut a 12-inch length of 1¼-inch-wide, type III nylon tape; sear the ends.
- c. Measure and mark 4-inches from each end. Fold the tape between the two marks to the center of the webbing and sew in place. Use a light-duty sewing machine, size E nylon thread, and 7 to 11 stitches per inch.

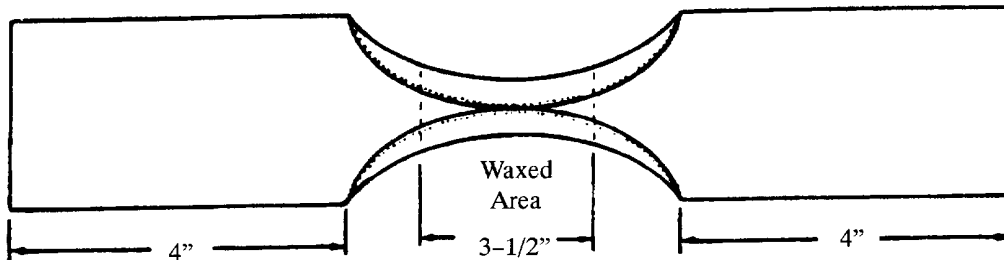

(B) Details For Forming And Waxing Loop

- d. Fold tape in the center and dip in a mixture of 50% beeswax and 50% paraffin wax for a distance of 1¾-inches.
- e. Fold the tape in the center. Place on top of the original stitch formation of the opening loop. Sew in place using a light-duty sewing machine, size E nylon thread, 7 to 11 stitches per inch, and a 4-inch point WW formation.

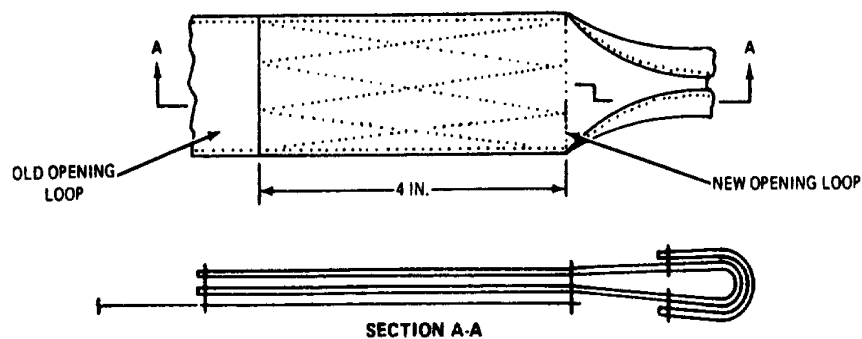

(C) Details For Stitching Loop To Pack Tray

5. *Inside retainer band keeper.* Replace as follows:
 - a. Cut the stitching and remove the damaged keeper from the side flap panel.

- b. Cut an 8-inch length of 1¼-inch-wide, type III nylon tape; sear the ends.

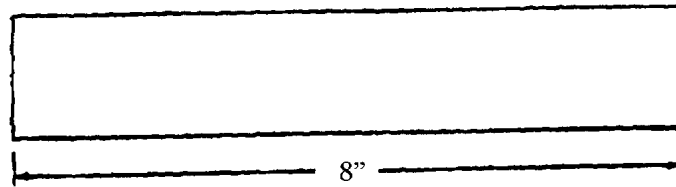

- c. Mark the tape 2-inches from each end. Fold the tape between the two 2-inch marks, to the center of the tape. Stitch each side using a light-duty sewing machine, size E nylon thread, and 7 to 11 stitches per inch.

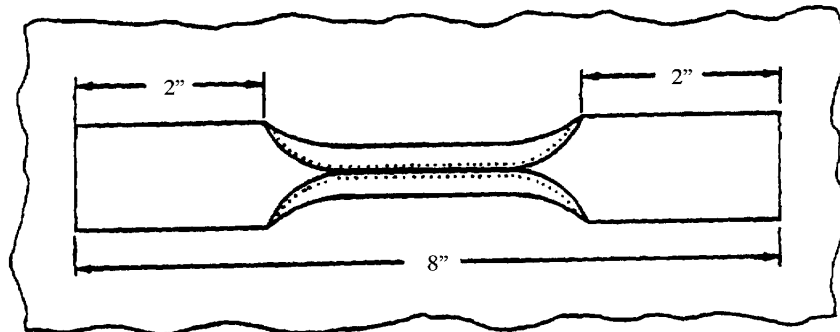

- d. Place the tape, with the folded edges up and the ends turned-under 1-inch, in the exact spot from which the damaged keeper was removed. Stitch in place with a single-X box-stitch formation, with a double row of stitching at the inside edges. Use a light-duty sewing machine, size E nylon thread, and 7 to 11 stitches per inch.

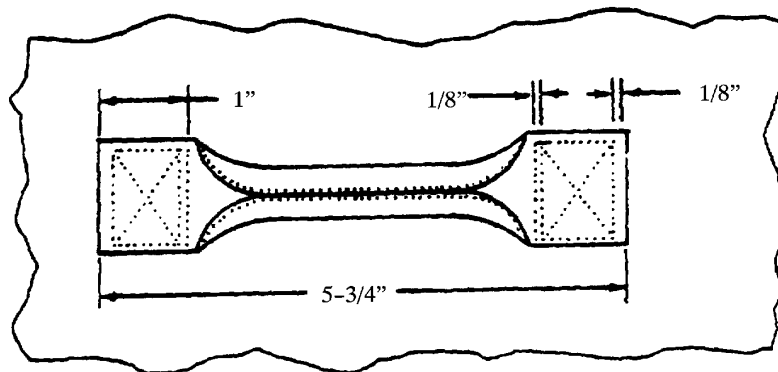

6. *Outside retainer band keeper.* Replace as follows:
- Cut the stitching and remove the damaged keeper from the side flap panel.
 - Cut a 7-inch length of type IV nylon webbing, 1-inch-wide; sear the ends.
 - Mark the webbing $\frac{1}{2}$ -inch and $\frac{11}{16}$ -inch from each end. Mark the webbing $1\frac{7}{8}$ -inches from each $\frac{11}{16}$ -inch mark.
 - Fold-under the webbing at the $\frac{1}{2}$ -inch mark and place in the exact location the damaged keeper was removed. Stitch in place with three straight rows of stitching. Use a light-duty sewing machine, size E nylon thread, and 7 to 11 stitches per inch.

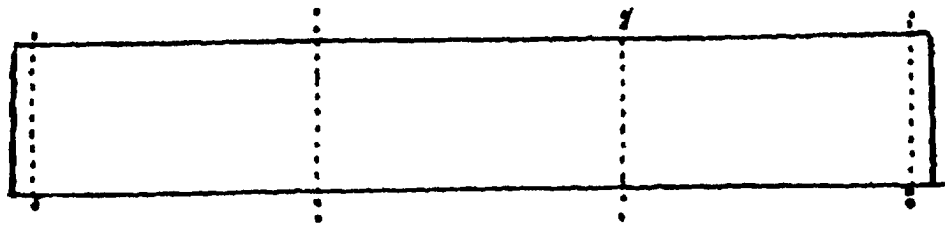

7. *Static Line Slack Retainer.* Replace as follows:
- Cut the stitching of the damaged retainer without cutting the pack body.
 - Cut a $3\frac{1}{4}$ -inch length of class I, cotton elastic webbing.

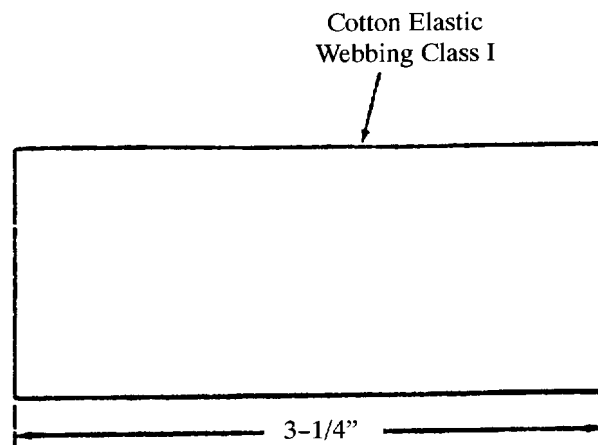

- Fold-under the ends $\frac{1}{2}$ -inch.
- Position the new retainer in the exact spot from which the damaged retainer was removed.

- e. Stitch in place with two rows of zig-zag stitching; follow the original construction. Use a zig-zag sewing machine, size E, nylon thread, and 7 to 11 stitches per inch. Overstitch the ends $\frac{1}{4}$ -inch.

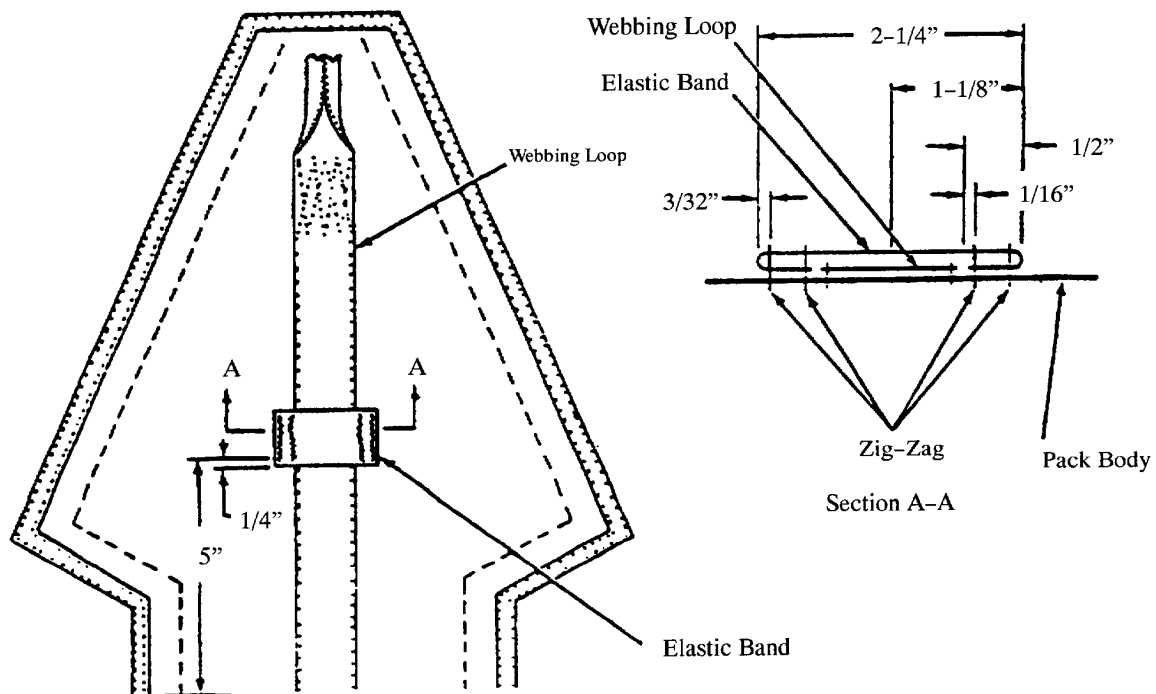

8. *Waistband*. Replace as follows:

NOTE

All unserviceable waistbands will be replaced with nylon waistbands from cannibalization.

- a. Cut the stitching that secures the waistband to the pack tray. Remove the loose threads. Ensure the pack tray material is not damaged during the cutting process.
- b. Turn-under the wide end of the replacement waistband $\frac{5}{8}$ -inch.
- c. Position the waistband on the outside of the pack in the exact spot from which the damaged waistband was removed.

- d. Sew the waistband using a heavy-duty sewing machine, size 3 nylon thread, and 5 to 8 stitches per inch; follow the details of the original construction.

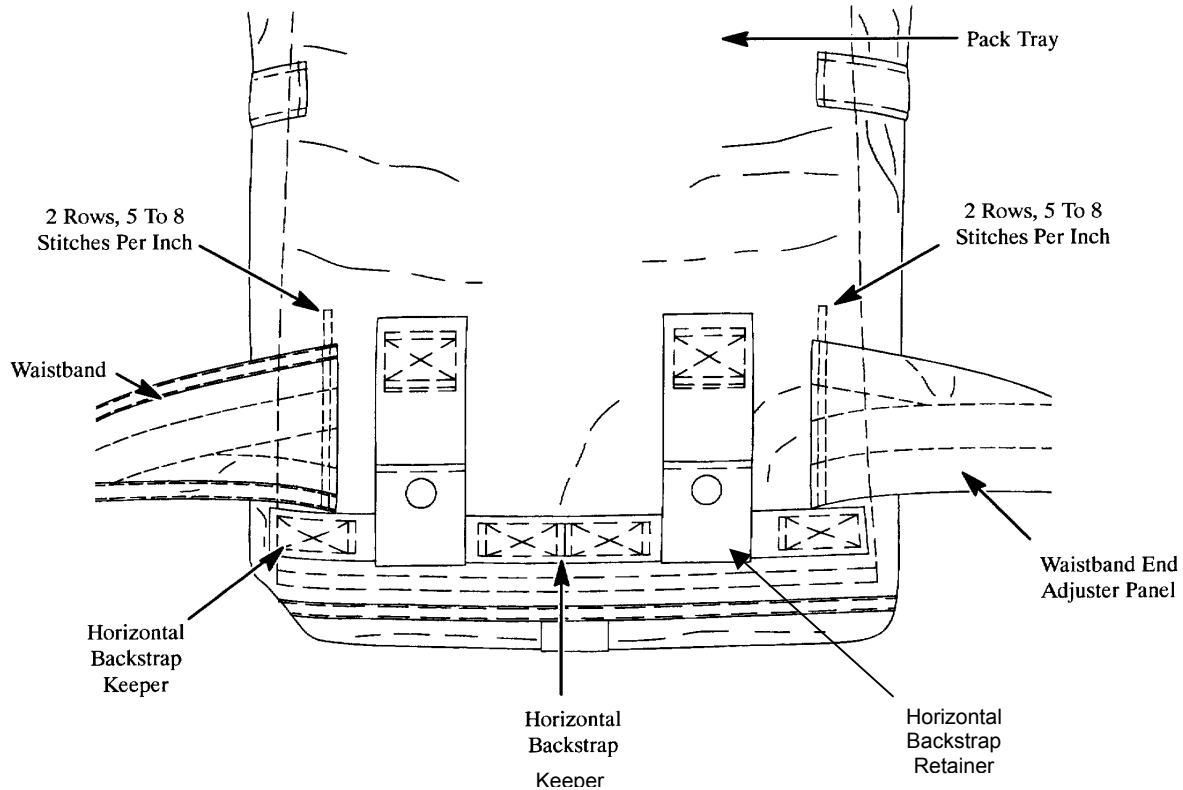

9. *Waistband adjuster panel.* Replace a damaged waistband adjuster panel by fabricating as follows:
- Cut the stitching that secures the original adjuster panel to the pack tray and remove the unserviceable panel; remove the cut stitching. Ensure the pack tray material is not damaged during the cutting process.
 - If the metal adapter on the original adjuster panel is serviceable, cut the panel webbing and remove the adapter for further use. If the adapter is not considered serviceable, replace with a serviceable item from stock.
 - Cut a 16 $\frac{1}{4}$ -inch length and a 5-inch length of 1 $\frac{23}{32}$ -inch-wide, type VIII, green nylon webbing; sear the ends of both lengths.

- d. Pass the 16¼-inch length of webbing around the center bar of a serviceable adapter; align the webbing ends. This length of material shall constitute the adjuster panel webbing.

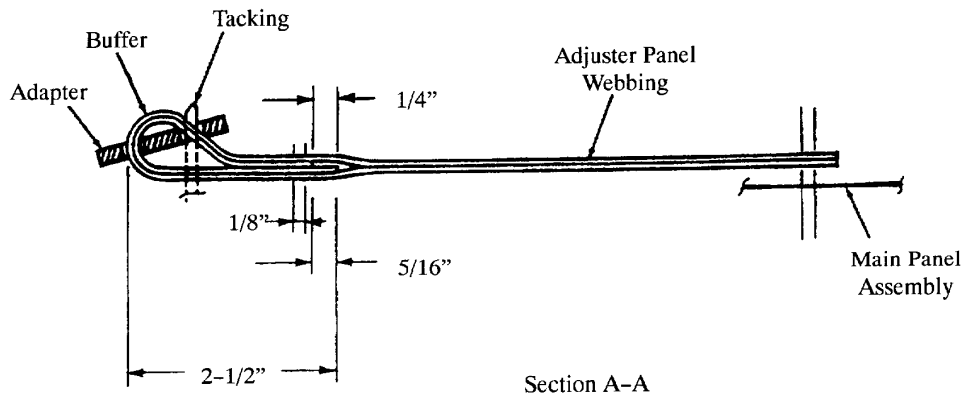
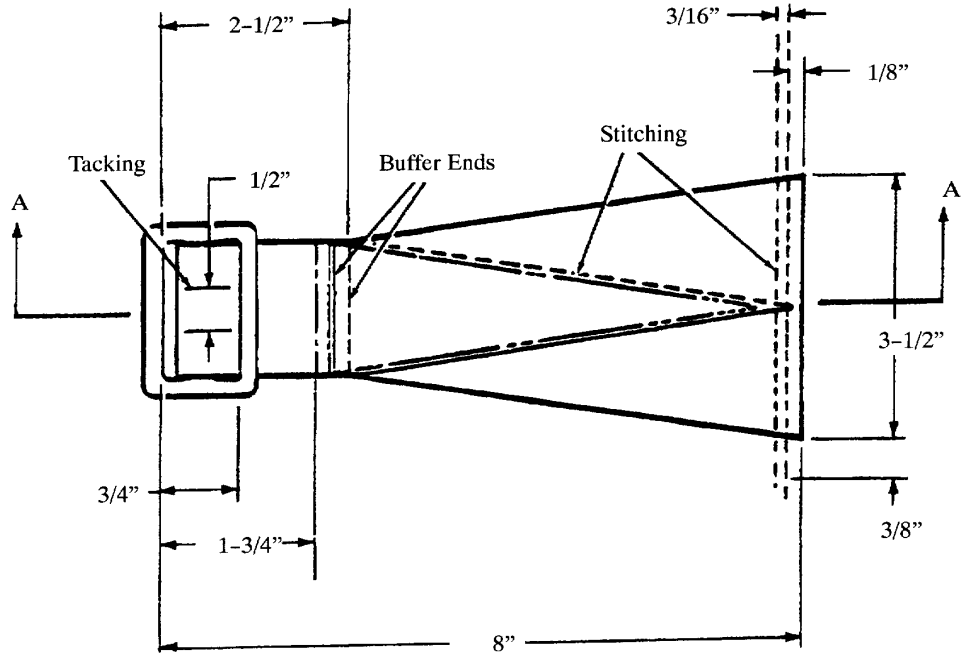

- e. Insert the 5-inch webbing length under the 16¼-inch webbing length, and pass the webbing length around the adapter center bar to form a buffer. Extend the bottom end of the buffer webbing ¼-inch beyond the top end.
- f. Hand-tack the buffer tightly to the adjuster panel webbing with two-turns of doubled tape, lacing and tying. Secure the tacking thread ends, on the bottom side of the adjuster panel webbing, with a square knot. Trim the tacking thread ends to ¼-inch.

- g. Beginning at a point 1 3/4-inches back from where the panel webbing passes around the adapter center bar, spread the webbing loose ends to form a 3 1/2-inch width, as shown in the illustration below. Secure the formed panel webbing by stitching; use a light-duty sewing machine, size E nylon thread, and 7 to 11 stitches per inch.

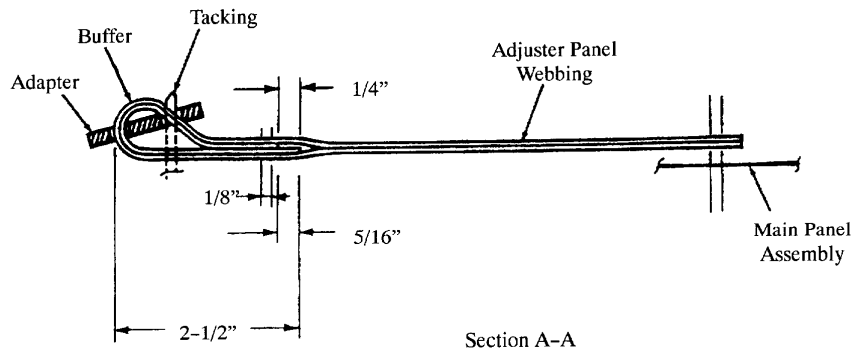
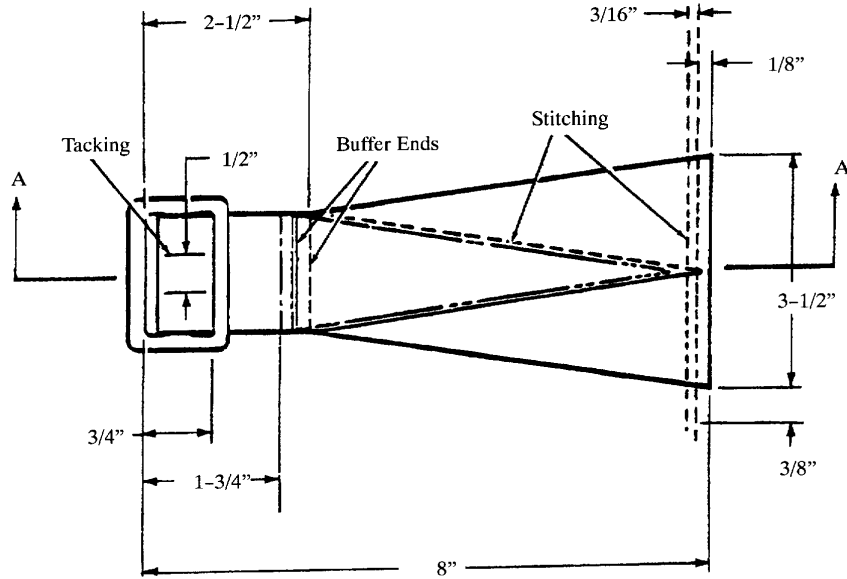

- h. Position the fabricated adjuster panel in the original location on the pack tray; secure the panel to the pack tray main panel using a heavy-duty sewing machine, size 3 nylon thread, and 5 to 8 stitches per inch.

10. *Waistband extension.* Refer to TM 10-1670-299-20&P.

END OF WORK PACKAGE

THIS PAGE INTENTIONALLY LEFT BLANK

CHAPTER 4

**DIRECT SUPPORT MAINTENANCE INSTRUCTIONS
FOR
MC1-1C TROOP BACK PARACHUTE ASSEMBLY
MC1-1D TROOP BACK PARACHUTE ASSEMBLY**

THIS PAGE INTENTIONALLY LEFT BLANK

DIRECT SUPPORT MAINTENANCE
MC1-1C/MC1-1D TROOP BACK PARACHUTE ASSEMBLY
SEWING PROCEDURES

THIS TASK COVERS:

- Basting and Temporary Tacking
 - Stitching and Restitching
 - Zig-Zag Sewing
-

INITIAL SETUP:**Equipment Condition**

Unpacked. Canopy with defects recorded.
Clean.

Personnel Required

92R(10) Parachute Rigger

Tools

Specified in paragraph applicable to the item being repaired.

Materials/ Parts

Specified in paragraph applicable to the item being repaired.

References

WP 0014 00

NOTE

Sewing requirements will vary according to the type of item being repaired and the type of repair being made. The type of sewing machine, type of thread, the stitch range, and the stitch pattern (if applicable) required to accomplish a sewing procedure will be specified in the paragraph applicable to the item being repaired. All original stitching that is cut during the performance of a sewing procedure will be removed from the applicable item. Immediately after the accomplishment of a machine sewing procedure, trim thread ends to a point as close as possible to the material that has been sewn.

BASTING AND TEMPORARY TACKING

Basting and temporary tacking are hand-sewing methods used to temporarily hold layers of cloth fabric together while a repair is being performed. The following is a list of procedures that apply to basting and temporary tacking actions:

1. Basting and temporary tacking should be made using thread that is of a contrasting color to the material being worked.
2. Basting and temporary tacking will be performed using a single strand of size A, nylon thread, or ticket No. 24/4 cotton thread.
3. When basting, do not tie knots at any point in the thread length. Also, the sewing should be made with two stitches per inch.
4. Immediately upon completion of a repair, remove previously made basting or temporary tacking.

STITCHING AND RESTITCHING

Perform stitching and restitching as follows, refer to Tables 1 and 2.

1. *Parachute canopy assemblies.* The stitching and restitching made on parachute canopies should be accomplished with thread that is contrasting in color to the fabric being restitched. If contrasting color thread is not available, thread of matching color may be used, providing all other specifications are met. Straight stitching and restitching on parachute canopy assemblies should be locked by at least 2-inches at each end of a stitch row, when possible. Zig-Zag stitching does not require locking; however, zig-zag restitching should extend at least ¼-inch into undamaged stitching at each end, when possible. When restitching parachute canopy assemblies, stitch directly over the original stitching and follow the original stitch pattern as closely as possible.

Table 1. Sewing Machine Code Symbols.

| CODE SYMBOL | SEWING MACHINE |
|-------------|--|
| LD | SEWING MACHINE, INDUSTRIAL: General Sewing; 301 Stitch; Light Duty; NSN 350-01-177-8590. |
| MD ZZ | SEWING MACHINE, INDUSTRIAL: Zig-Zag; 308 Stitch; Medium Duty; NSN 3530-01-181-1421. |
| LD ZZ | SEWING MACHINE, INDUSTRIAL: Zig-Zag; 308 Stitch; Light Duty; NSN 3530-01-181-1420. |
| HD | SEWING MACHINE, INDUSTRIAL: General Sewing; 301 Stitch; Heavy Duty; NSN 3530-01-177-8588. |
| MD | SEWING MACHINE, INDUSTRIAL: General Sewing; 301 Stitch; Medium Duty; NSN 3530-01-177-8591. |
| DN | SEWING MACHINE, INDUSTRIAL: Darning; Lock Stitch; NSN 3530-01-177-8589. |
| LHD | SEWING MACHINE, INDUSTRIAL: 301 Stitch; Light-Heavy Duty; NSN 3530-01-186-3079. |
| ND | SEWING MACHINE, INDUSTRIAL: 301 Stitch; Double-Needle; NSN 3530-01-182-2873. |

Table 2. Stitching and Restitching Specifications.

| COMPONENT | RECOMMENDED SEWING MACHINE (CODE SYMBOL) | STITCHES PER INCH | THREAD SIZE |
|-----------------|--|-------------------|-------------|
| Gore Section | DN LD ZZ | 7 to 11 Darn | A or E E |
| Suspension Line | MD ZZ | 7 to 11 | E |
| Vent Line | MD ZZ | 7 to 11 | E |
| Radial Tape | LD ZZ | 7 to 11 | E |

2. *Other parachute items.* Stitching and restitching on other parachute items constructed from cloth, canvas, and webbing should be accomplished with thread that matches the color of the original stitching, when possible. All straight stitching should be locked by backstitching at least $\frac{1}{2}$ -inch. Restitching should be locked by overstitching each end of the stitch formation by $\frac{1}{2}$ -inch. Zig-zag stitching does not require locking; however, zig-zag restitching should extend at least $\frac{1}{4}$ -inch into undamaged stitching at each end, when possible. Restitching should be made directly over the original stitching; follow the original stitch pattern as closely as possible.

ZIG-ZAG SEWING

(Refer to Tables 1 and 2). Components of the MC1-1C/MC1-1D, except parachute canopy, that have sustained cut or tear damage, may be repaired by zig-zag sewing, provided the applicable damaged area does not have any material missing and the cut or tear is straight or L-shaped. Should the damaged area be irregular shaped or have material missing, the repair will be achieved by either darning or patching, as required. A zig-zag sewing repair will be accomplished using a zig-zag sewing machine, with the following procedures:

1. Set the sewing machine to the maximum stitch width.
2. Beginning at a point $\frac{1}{4}$ -inch beyond one end of the cut or tear, stitch lengthwise along the damaged area to a point $\frac{1}{4}$ -inch beyond the opposite end of the cut or tear.



3. The cited stitching procedure will also apply to an L-shaped cut or tear.

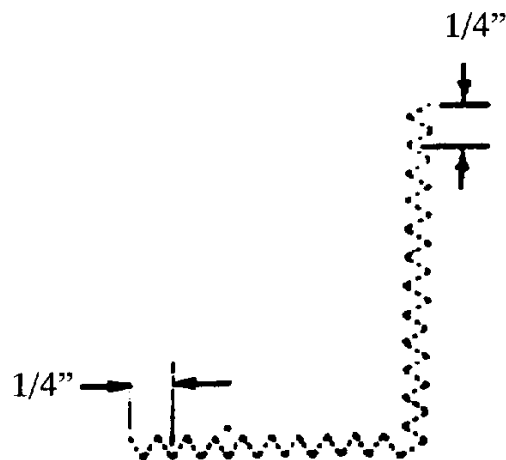

4. If applicable, restencil informational data or identification marks as prescribed in WP 0014 00.

END OF WORK PACKAGE

DIRECT SUPPORT MAINTENANCE
MC1-1C/MC1-1D TROOP BACK PARACHUTE ASSEMBLY
SEARING AND WAXING

THIS TASK COVERS:

- Searing
- Waxing

INITIAL SETUP:**Tools**

Pot, Melting, Electric (Item 24, WP 0042 00)
Knife, Hot, Metal (Item 14, WP 0042 00)

Personnel Required

92R(10) Parachute Rigger

Materials/Parts

Beeswax (Item 2, WP 0055 00)
Wax, Paraffin (Item 55, WP 0055 00)

Equipment Condition

Unpacked.

NOTE

Cotton tape, webbing, or cord will not be seared.

NOTE

Fabric materials such as cord, tape, and webbing, that are cut for use in the maintenance of the MC1-1C/MC1-1D parachute, will normally be heat-seared or dipped in a melted wax mixture, as applicable, to prevent the material from fraying or unraveling. However, in some instances, the preparation of the material may not be necessary and will be specified accordingly.

SEARING

The cut ends of nylon tape, webbing and cord lengths may be prepared by heat-searing, which is performed by pressing the raw end of the material against a hot metal surface (knife) until the nylon has melted sufficiently. Avoid forming a sharp edge or lumped effect on the melted end.

WAXING

The fraying or unraveling of cotton or nylon tape, webbing, and cord length ends may be prevented by dipping ½-inch of the raw end of the material into a thoroughly melted mixture of half beeswax and half paraffin in an electric melting pot. The wax temperature should be substantial enough to ensure the wax completely penetrates the material, rather than just coating the exterior fabric.

END OF WORK PACKAGE

THIS PAGE INTENTIONALLY LEFT BLANK

DIRECT SUPPORT MAINTENANCE
MC1-1C/MC1-1D TROOP BACK PARACHUTE ASSEMBLY
MARKING AND RESTENCILLING

THIS TASK COVERS:

- Marking
- Restencilling
- Remarking and Restencilling

INITIAL SETUP:**Materials/Parts**

Brush, Stenciling (Item 4, WP 0055 00)
Ink, Marking (Item 22, WP 0055 00)
Marker, Felt Tip, Black (Item 25, WP 0055 00)
Pen, Ball Point (Item 28, WP 0055 00)
Stencil Board, Oiled (Item 35, WP 0055 00)

Personnel Required

92R(10) Parachute Rigger

Equipment Condition

Laid out on packing table or other suitable area.

NOTE

Stenciling should be used whenever possible. A ballpoint pen or felt tip marker should be used only where stenciling is not possible, or when stenciling devices are not available. Any type ballpoint pen using black or blue ink may be used for marking on labels only.

Original stenciled data or marking that becomes faded, illegible, obliterated, or removed as a result of performing a repair procedure, will be remarked with a ballpoint pen, felt tip marker, or restenciled. All marking or restencilling will be done on, or as near as possible to, the original location and should conform to the original lettering type and size.

MARKING

Using marking devices, such as a ballpoint pen or felt tip marker, mark on, or as near as possible to, the original location and conform to the original lettering type and size.

RESTENCILING

Proceed as follows:

1. Cut oiled stencil board to match the original lettering type and size of data to be restenciled.
2. Place cut stencil board over, or as near as possible to, the original marking to be restenciled.
3. Place an additional sheet of stencil board beneath the area to be restenciled to prevent the marking ink from penetrating to other areas.
4. Hold the stencil board in place and, using the stenciling brush filled with parachute marking ink, restencil the original marking.

REMARKING AND RESTENCILING

Remark/restencil the original stenciled data/markings that become faded, illegible, obliterated, or that have been removed as a result of performing a repair procedure. Ensure all marking/restencilling is on, or as near as possible to, the original location, and conforms to the original lettering type and size.

END OF WORK PACKAGE

DIRECT SUPPORT MAINTENANCE
MC1-1C/MC1-1D TROOP BACK PARACHUTE ASSEMBLY
VENT LINES

THIS TASK COVERS:

- Repair
 - Replace
-

INITIAL SETUP:**Equipment Condition**

Unpacked. Canopy in proper layout.

Personnel Required

92R(10) Parachute Rigger

Tools

Knife (Item 13, WP 0042 00)
Knife, Hot Metal (Item 14, WP 0042 00)
Sewing Machine, Zig-Zag (Table 1, WP 0012 00)
Shears (Item 28, WP 0042 00)
Pot, Melting, (Item 24, WP 0042 00)

Materials/ Parts

Wax, Paraffin (Item 55, WP 0055 00)
Cord, Nylon, Type II (Item 14, WP 0055 00)
Thread, Nylon, Size E, Natural (Item 49/52,
WP 0055 00)

References

Group No. 01, MAC (WP 0045 00)

REPAIR

Repair vent lines requiring restitching, as follows:

1. Use a zig-zag sewing machine to restitch any loose or broken stitches.
2. Restitch over the original stitch pattern using nylon thread, size E. Overstitch ½-inch to lock stitches.

REPLACE

Replace missing or damaged vent lines as follows:

1. Place canopy in proper layout on the table and trace the damaged vent line across the apex, from upper lateral band.
2. Remove damaged vent line by cutting stitching that holds the line to the canopy at both sides of the apex.
3. Cut a 27-inch length of type II, nylon cord. Sear or dip ends of cord.

4. Position one end of the new vent line in the exact location formerly occupied by the end of the old line.

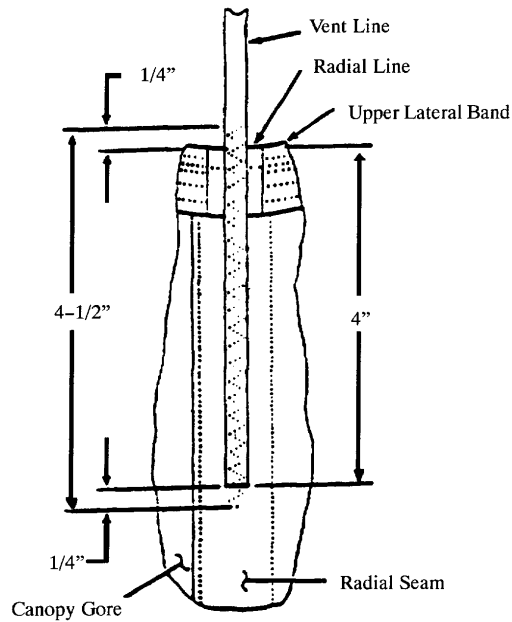

NOTE

Measuring from the outside edge of the upper lateral band, the vent line should extend 4-inches into the radial seam.

5. Using a zig-zag sewing machine and nylon thread, size E, stitch the new line in place. Begin stitching on the line 1/4-inch above the upper edge of the upper lateral band; sew to 1/4-inch beyond the end of the line, 7 to 11 stitches per inch and 1/8-inch wide.
6. Pass the remaining end of the line under the other vent lines, and through the bridle loop, as required.
7. Position and sew the remaining end of the line to the opposite side of the canopy, as detailed in steps 4. and 5., above.

END OF WORK PACKAGE

DIRECT SUPPORT MAINTENANCE
MC1-1C/MC1-1D TROOP BACK PARACHUTE ASSEMBLY
GORE SECTIONS

THIS TASK COVERS:

- Replace

INITIAL SETUP:**Tools**

Knife (Item 13, WP 0042 00)
Needle, Basting (Item 18, WP 0042 00)
Sewing Machine, Light-Duty (Table 1, WP 0012 00)
Sewing Machine, Darning (Table 1, WP 0012 00)
Shears (Item 28, WP 0042 00)

Materials/Parts

Brush, Stenciling (Item 4, WP 0055 00)
Cloth, Parachute Mending (Item 11, WP 0055 00)
Cloth, Parachute, Nylon, 1.1-oz. (Item 12/13, WP 0055 00)
Thread, Cotton (Item 48, WP 0055 00)
Thread, Nylon, Size A (Item 51, WP 0055 00)
Thread, Nylon, Size E (Item 49/52, WP 0055 00)
Stencil Board, Oiled (Item 35, WP 0055 00)
Pushpins (Local Purchase)

Personnel Required

92R(10) Parachute Rigger

Equipment Condition

Parachute canopy laid out on table.

References

Group No. 01, MAC (WP 0045 00)

REPLACE

When replacing gore sections, use F-111 pattern, nylon cloth of same color as that being replaced. If the same color cloth is not available, another color may be used. When replacing section 1 of gore 1, restencil the gore number and information data block on the replacement section. For other gores, stencil gore numbers as necessary.

NOTE

Mending cloth will be used for patching only.

1. *Section 3 or 4.* Replace as follows (see illustrations on next page):

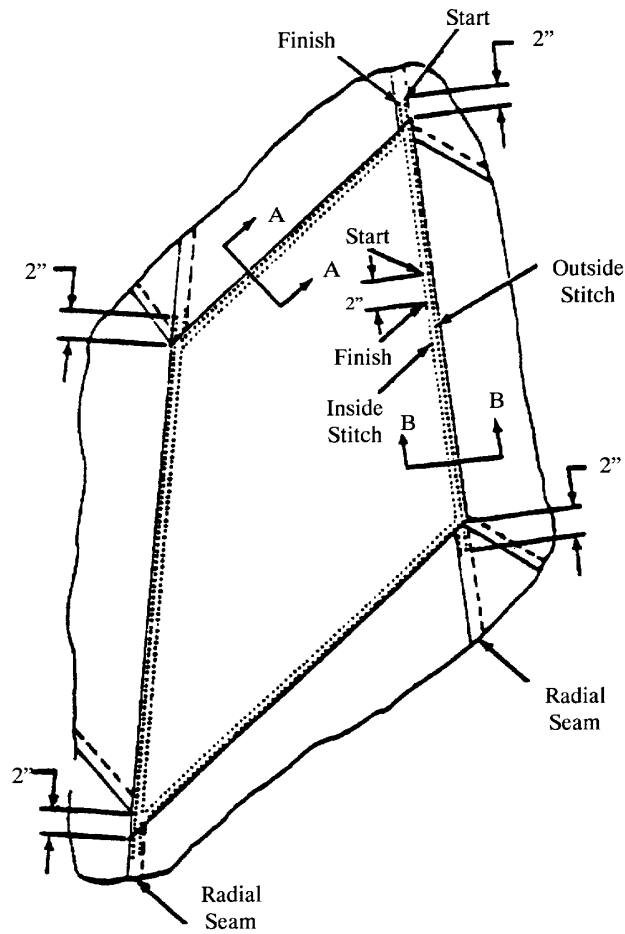

Gore Section 3 or 4

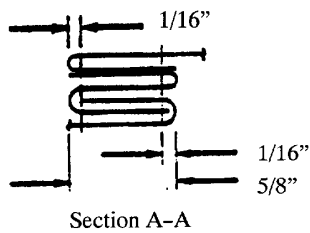

Section A-A

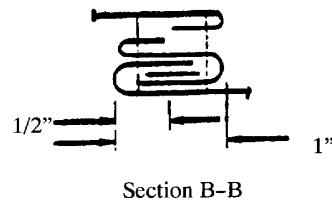

Section B-B

- a. Invert the canopy and center the damaged section on the work table.
- b. Smooth the area around the damaged section; ensure that the radial and diagonal seams are straight. Place the pins through radial and diagonal seams as far above and below the damaged sections, as necessary.
- c. Remove damaged section by cutting fabric 1/2-inch from all seams, except at a skirt and upper or lower lateral band where sections can be cut out flush with the lateral band.

- d. Fold back raw edges of trimmed seams 1/2-inch and baste to the seam with ticket No. A, nylon thread, or ticket No. 24/4 cotton thread.
 - e. Bias-cut a piece of appropriate nylon parachute cloth for the new section; allow at least 3-inches of extra fabric on each raw edge.
 - f. Position the new fabric so that the selvedge edges lie parallel to, and overlap, diagonal seams.
 - g. Turn-under the edges along the diagonal seams 1/2-inch so that the turned edges are aligned with the outside edges of the diagonal seams. Secure to the table with pushpins.
 - h. Turn-under the edges along the radial seam so the folded edges are aligned with the center of the radial seams. Measure 1-inch from the outside of the radial seam as a guide and cut off the excess material. Turn-under edges along radial seam so the folded edge is aligned with the outside edge of the radial seam.
 - i. Baste all edges and remove the pushpins.
 - j. Using a light-duty sewing machine and size E, nylon thread, sew a row of stitches, 7 to 11 stitches per inch, around the outside edge of the new section, as shown above.
 - k. Turn the canopy right side out. Using a light duty sewing machine, and size E, nylon thread, sew a row of stitches, 7 to 11 stitches per inch, around the inside edge of the new section.
 - l. Remove all basting and make certain radial tape moves freely in the channel.
2. *Section 1 or 2.* Replace as follows (see illustrations below and next page):

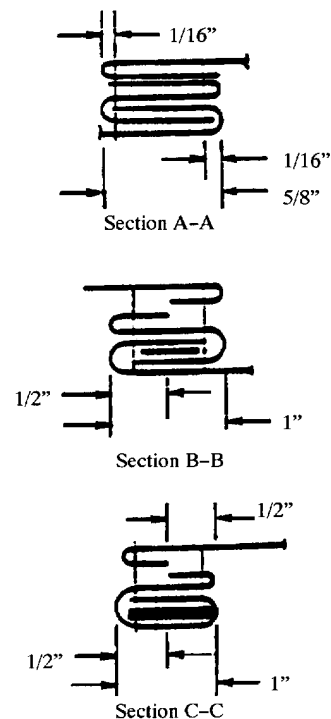
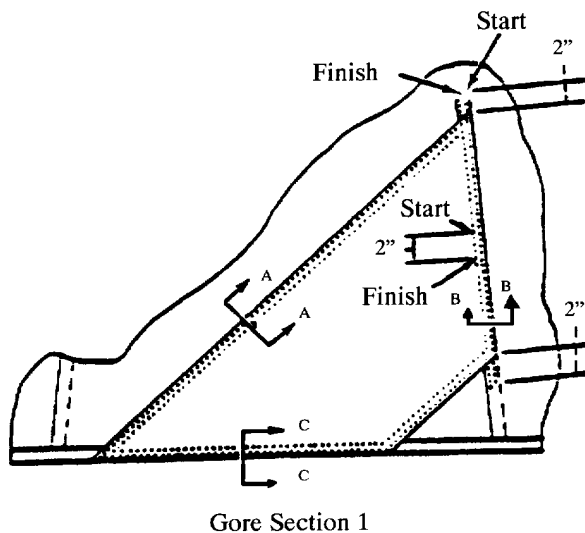

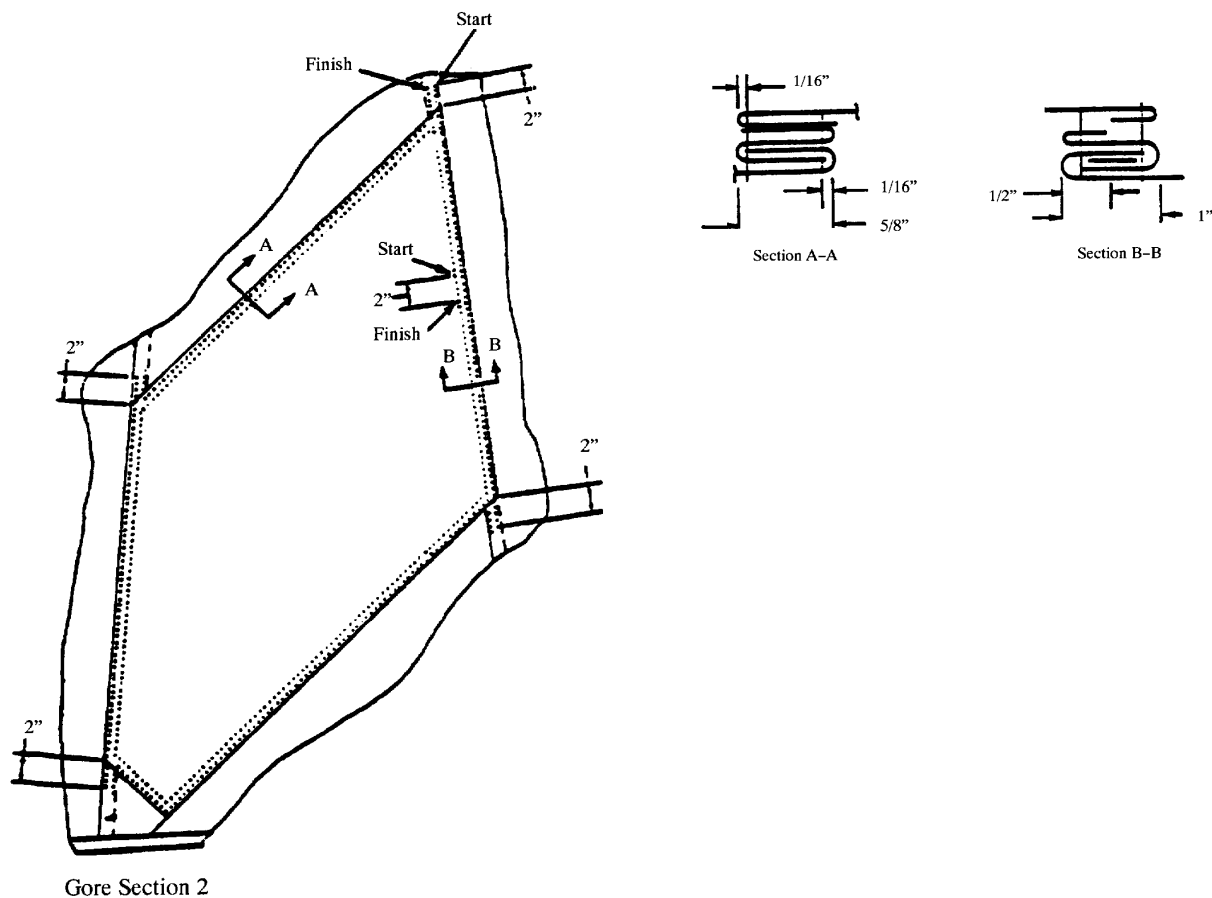

- a. Invert the canopy and center the damaged section on the worktable.
- b. Smooth the area around the damaged section; ensure that the radial and diagonal seams are straight. Place pins through the radial and diagonal seams, as far above and below the damaged sections as necessary.
- c. Remove the damaged section by cutting the fabric $\frac{1}{2}$ -inch from all seams, except at the lower lateral band, where the section can be cut out flush with the lateral band.
- d. If the damage does not extend into the corner bounded by the radial seam and the lower lateral band, cut the fabric diagonally across the corner, leaving the corner intact. Leave enough fabric at the corner so that when the new section is installed it will not overlap the pocket band or V-tab. Adapt the procedures in step 1., above, to complete the section replacement.
- e. If the damage extends into the corner bounded by the radial seam and lower lateral band, cut and remove the stitching that holds the V-tab and pocket band (if present). Adapt procedures in step 1., above, to replace the section. Then sew the V-tab and pocket band in place.
- f. Fold back the raw edges of the trimmed seams $\frac{1}{2}$ -inch and baste to the seam with size A, nylon thread, or ticket No. 24/4 cotton thread.

- g. Bias-cut a piece of appropriate nylon parachute cloth for new section, allowing at least 3-inches of extra fabric on each raw edge. Position new fabric so that the selvedge edges lie parallel to, and overlap, the diagonal seams.
 - h. Turn-under the edges along the diagonal seams ½-inch so that the turned edges are aligned with the outside edges of the diagonal seams. Secure to the table with pushpins.
 - i. Turn-under the edges along the radial seam so the folded edges are aligned with the center of the radial seams. Measure 1-inch from the outside edge of the radial seams as a guide and cut off the excess material. Turn-under the edges along the radial seam so the folded edge is aligned with the outside edge of the radial seam.
 - j. Baste all edges and remove the pushpins.
 - k. Using a light-duty sewing machine and size E, nylon thread, sew a row of stitches, 7 to 11 stitches per inch, around the outside edge of the new section.
 - l. Turn the canopy right-side-out. Using a light-duty sewing machine and size E, nylon thread, sew a row of stitches, 7 to 11 stitches per inch, around the inside edge of the new section.
 - m. Remove all basting; make certain the radial tape moves freely in the channel.
3. *Section 5.* Replace as follows (see illustrations A and B below and next page):

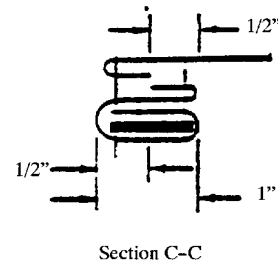
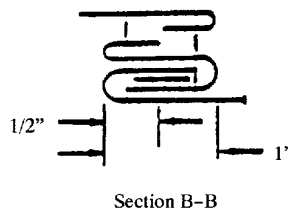
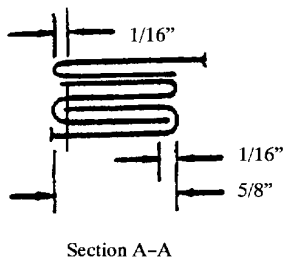
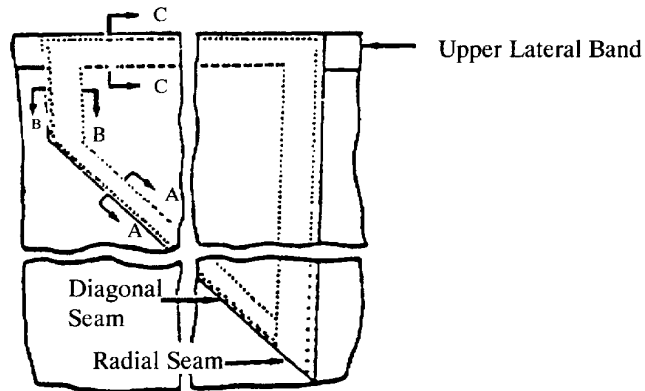

(A) Inside View

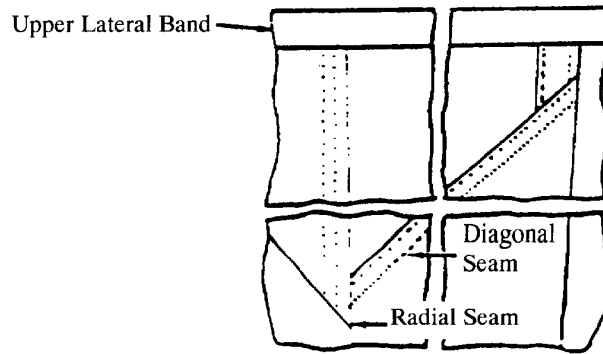

(B) Outside View

- a. Invert the canopy and center the damaged section on the worktable.
- b. Smooth the area around the damaged section; ensure that the radial and diagonal seams are straight. Place the pins through the radial and diagonal seams as far above and below the damaged sections as necessary.
- c. Remove the damaged section by cutting fabric $\frac{1}{2}$ -inch from all the seams except at a skirt and upper or lower lateral band, where the section can be cut out flush with the lateral band.
- d. Fold back the raw edges of the trimmed seams $\frac{1}{2}$ -inch and baste to the seam with size A, nylon thread, or ticket No. 24/4, cotton thread.
- e. Bias-cut a piece of appropriate nylon parachute cloth for the new section; allow at least 3-inches of extra fabric on each raw edge.
- f. Position the new fabric so that the selvedge edges lie parallel to, and overlap, the diagonal seams.
- g. Turn-under the edges along the radial seams $\frac{1}{2}$ -inch so that the turned edges are aligned with the outside edges of the diagonal seams. Secure to the table with pushpins.
- h. Turn-under the edges along the radial seam so the folded edges are aligned with the center of the radial seams. Measure 1-inch from the outside of the radial seam as a guide and cut off the excess material. Turn-under the edges along the radial seam so the folded edge is aligned with the outside edge of the radial seam.
- i. Baste all edges and remove the pushpins.
- j. Using a light-duty sewing machine and size E, nylon thread, sew a row of stitches, 7 to 11 stitches per inch, around the outside edge of the new section.
- k. Turn the canopy right-side-out. Using a light-duty sewing machine and size E, nylon thread, sew a row of stitches, 7 to 11 stitches per inch, around the inside edge of the new section.
- l. Remove all basting and make certain the radial tape moves freely in the channel.

END OF WORK PACKAGE

DIRECT SUPPORT MAINTENANCE
MC1-1C/MC1-1D TROOP BACK PARACHUTE ASSEMBLY
RADIAL TAPE

THIS TASK COVERS:

- Replace

INITIAL SETUP:**Tools**

Needle, Tacking (Item 19, WP 0042 00)
Sewing Machine, Zig-Zag (Table 1, WP 0012 00)
Shears (Item 28, WP 0042 00)

Personnel Required

92R(10) Parachute Rigger

Equipment Condition

Parachute canopy laid out on table.

Materials/Parts

Webbing, Nylon, Type I (Item 62, WP 0055 00)
Thread, Nylon, Size E (Item 49/52, WP 0055 00)

REPLACE

1. Place canopy in proper layout on repair table or repair surface; apply partial tension to suspension lines.
2. Trace damaged radial tape from the canopy skirt, through the radial seam channel, to the canopy apex.
3. Cut the stitching that holds the vent line and the radial tape to the upper lateral band and radial seam; lay next to the end of the vent line.
4. Cut the stitching that holds the suspension line and radial tape to the lower lateral band and the radial seam; lay it next to the end of the suspension line. Do not remove the damaged radial tape at this time.
5. Tack the end of the new radial tape to the end of the damaged radial tape at the upper lateral band.
6. Grasp the end of the damaged radial tape, at the lower lateral band, and pull the old tape through the radial seam channel until the new tape appears at the lower lateral band. Relieve the tension from the suspension lines.
7. Cut the old tape from the new tape at the tacking. Hand tack the ends of the new radial tape in place, at the upper and lower lateral bands, after taking appropriate measurement of the adjacent tape.
8. Cut the ends of the new tape at the outside edges of the upper and lower lateral bands. Reposition the ends of the vent line and suspension line; sew in place according to the original construction.

END OF WORK PACKAGE

THIS PAGE INTENTIONALLY LEFT BLANK

DIRECT SUPPORT MAINTENANCE
MC1-1C/MC1-1D TROOP BACK PARACHUTE ASSEMBLY
SUSPENSION LINE

THIS TASK COVERS:

- Replace
-

INITIAL SETUP:**Equipment Condition**

Unpacked. Canopy in proper layout.

Personnel Required

92R(10) Parachute Rigger

Tools

Knife (Item 13, WP 0042 00)
 Knife, Hot Metal (Item 14, WP 0042 00)
 Pot, Melting, Electric (Item 24, WP 0042 00)
 Sewing Machine, Medium-Duty, Zig-Zag
 (Table 1, WP 0012 00)
 Shears (Item 28, WP 0042 00)

Materials/ Parts

Beeswax (Item 2, WP 0055 00)
 Cord, Nylon, Type II (Item 14, WP 0055 00)
 Thread, Nylon, Size E (Item 49/52, WP 0055 00)

References

Group No. 01, MAC (WP 0045 00)

REPLACE

Replace a suspension line as follows:

1. Place the canopy in proper layout on the repair table or repair surface, and apply partial tension to the suspension lines.
2. Trace the damaged suspension line, from canopy skirt to link assembly.
3. Cut the stitching that holds the line to the canopy skirt and the V-tab. Do not remove the V-tab unless it is damaged. Cut the stitching that holds the line to the connector link; remove the line.
4. Cut a sufficient length of type II, nylon cord to allow sewing through the V-tab, and tying and sewing at the connector link. Sear or dip one end of the cord in wax.
5. Pass the seared end of the new cord up through the V-tab. Position the seared end in the exact location formerly occupied by the old line; sew in place according to details shown in the illustration below. Use a zig-zag sewing machine, size E nylon thread, and 7 to 11 stitches per inch. Start sewing $\frac{1}{4}$ -inch below the V-tab.

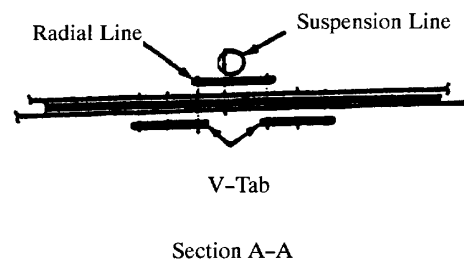
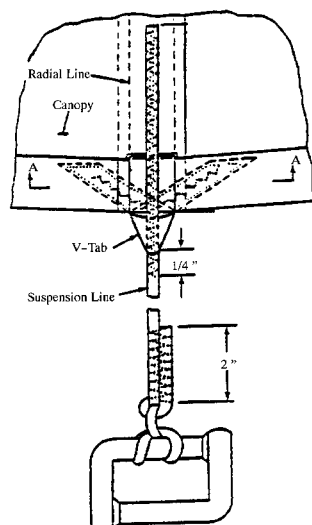

6. Hold the adjacent line and the new line tightly together at the lower lateral band; trace both lines, from the canopy skirt to the link assembly, under equal tension. Mark the new line at a point even with the inside edge of the link. Apply equal tension to both lines and check correctness of marking.
7. Relieve tension on all lines and attach the new suspension line to the link assembly with a clove-hitch and a half-hitch.

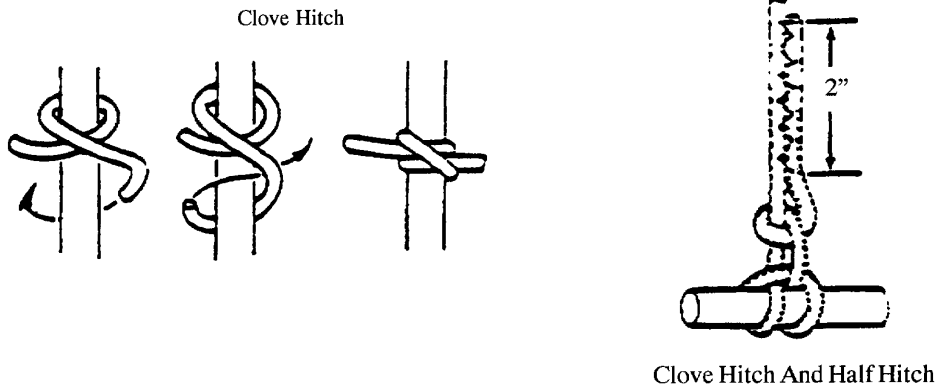

8. Drawing the new line down through the V-tab may reverse the procedures above; attach the new line to link assembly, then to the canopy skirt.
9. Extend each tie running end toward the canopy skirt and, beginning at a point 2-inches above the knots made in step 7., secure each tie running end to the replacement canopy line body by stitching a $\frac{3}{16}$ -inch-wide by 2-inch-long double-throw, zig-zag stitch formation toward the connector link assembly. Finish each stitch formation as close as possible to the securing knots and trim each running end to $\frac{1}{4}$ -inch. Use size E, nylon thread, and 7 to 11 stitches per inch.
10. Compare the knots securing each end of the replacement canopy line with the adjacent knots made on the connector link assembly to ensure compatibility. In addition, trace each end of the replacement line from the connector link assembly to the canopy skirt to ensure proper attachment, position, and sequence.
11. Sew the anti-inversion net to the new suspension line using a medium-duty zig-zag sewing machine, 5 to 8 stitches per inch, and a $\frac{1}{8}$ -inch throw. Extend the stitching above and below the net by $\frac{1}{2}$ -inch.

END OF WORK PACKAGE

**MC1-1C/MC1-1D TROOP BACK PARACHUTE ASSEMBLY
PREPARATION FOR STORAGE**

THIS WORKPACKAGE COVERS:

- Storage Criteria
 - General Storage Requirements
 - Storage Specifics for Parachutes
-

INITIAL SETUP:**Personnel Required**

92R(10) Parachute Rigger

Equipment Condition

Unpacked.

STORAGE CRITERIA

Administrative storage of the MC1-1C/MC1-1D Parachute Assembly will be accomplished in accordance with AR 750-1, and the instructions furnished below.

GENERAL STORAGE REQUIREMENTS

To ensure that serviceability standards of the stored parachute assembly are maintained, every effort will be exerted to adhere to the following general storage requirements:

1. When available, a heated building should be used to store parachutes.
2. Parachutes will be stored in a dry, well-ventilated location and protected from pilferage, dampness, fire, dirt, insects, rodents, and direct sunlight.
3. Parachutes will not be stored in a manner which would prevent ventilation or interfere with light fixtures, heating vents, fire fighting devices, cooling units, exits, or fire doors.
4. Parachutes will not be stored in a damaged, dirty, or damp condition.
5. All stored parachute items will be marked, segregated, and located for accessibility and easy identification.
6. Parachutes will not be stored in direct contact with any building floor or wall. Storage will be accomplished using bins, shelves, pallets, racks, or dunnage to provide airspace between the storage area floor and the equipment. If the pre-constructed shelving or similar storage accommodations are not available, locally fabricate storage provisions using suitable lumber or wooden boxes.
7. All available material handling equipment should be used as much as possible in the handling of parachutes.
8. Periodic rotation of stock, conversion of available space, proper housekeeping policies, and strict adherence to all safety regulations will be practiced at all times.

STORAGE SPECIFICS FOR PARACHUTES

In addition to the storage requirements stipulated in the general storage requirements paragraph, above, the following is a list of specifics that must be enforced when storing parachutes:

1. Except for those assemblies required for contingency operation, parachutes will not be stored in a packed configuration.

2. Stored parachute assemblies will be secured from access by unauthorized personnel.
3. A parachute that is in storage, and is administered a cyclic repack and inspection, will not be exposed to incandescent light or indirect sunlight for a period of more than 36-hours. In addition, exposure to direct sunlight will be avoided entirely.

END OF WORK PACKAGE

**MC1-1C/MC1-1D TROOP BACK PARACHUTE ASSEMBLY
PREPARATION FOR SHIPMENT**

THIS WORKPACKAGE COVERS:

- In-Storage Inspection
 - Shipment
 - Accordion Folding/Rigger Rolling
-

INITIAL SETUP:**Personnel Required**

92R(10) Parachute Rigger

Equipment Condition

Unpacked.

IN-STORAGE INSPECTION

General Information. An in-storage inspection is a physical check conducted on a random sample of airdrop equipment that is located in storage. Authorized rigger personnel (MOS 92R(20)) will conduct this inspection.

Intervals. Parachutes in storage will be inspected at least semiannually and at more frequent intervals if prescribed by the local parachute maintenance officer.

Inspection. Inspect to ensure that the back parachute is ready for issue.

1. Check the back parachute for proper identification.
2. Check that no damage or deterioration has been incurred.
3. Ensure that all modifications, or similar requirements, have been completed.
4. Check the adequacy of the storage facilities, efforts taken to control pests and rodents, and protection against unfavorable climatic conditions.

SHIPMENT

Initial Shipment. The initial packaging and shipping of parachutes are the responsibility of item manufacturers, who are required to comply with federal and military packing specifications, as stipulated in contractual agreements. Parachutes are normally shipped to depot activities, by domestic freight or parcel post, and packed to comply with overseas shipping requirements. Except for those parachute that are unpackaged and subjected to random inspections or testing by depot activity, parachutes received by a using unit will be contained in the original packaging materials.

Shipping Between Maintenance Activities. The shipping of parachutes between activities will be accomplished on a signature verification basis using whatever means of transportation is available. Used parachutes and other fabric items will be tagged in accordance with DA PAM 738-751, and rolled, folded, or placed loosely in a parachute pack, deployment bag, or other suitable container, as required. Unused parachutes will be transported in original shipping containers. During shipment, every effort will be made to protect parachute from weather elements, dust, dirt, oil, grease, and acids. Vehicles used to transport parachutes will be inspected to ensure the items are protected from the previously cited material damaging conditions.

Other Shipping Instructions. Parachutes destined for domestic or overseas shipment will be packaged and marked in accordance with AR 700-15, TM 38-230-1, and TM 38-230-2. Shipment of parachutes will be accomplished in accordance with TM 10-1670-201-23.

ACCORDION FOLDING/RIGGER ROLLING

Accordion Folding. Personnel parachute canopy assemblies that are not packed for use should be accordion folded prior to entry into storage. To accordion fold a parachute canopy assembly, perform the following:

1. Place the parachute canopy in proper layout under partial tension and dress the outside edges of both gore groups.
2. Fold the left group of gores over the right group. Release the tension.

Folding Of Gore Groups Completed

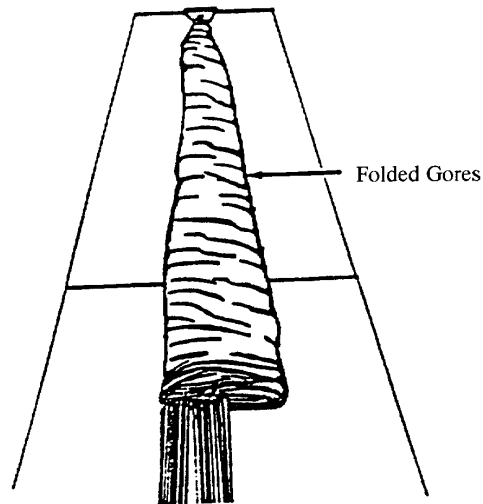

3. CHAIN the suspension lines and S-fold the CHAINED lines on top of the applicable parachute pack.

Suspension Lines Stowed On Pack

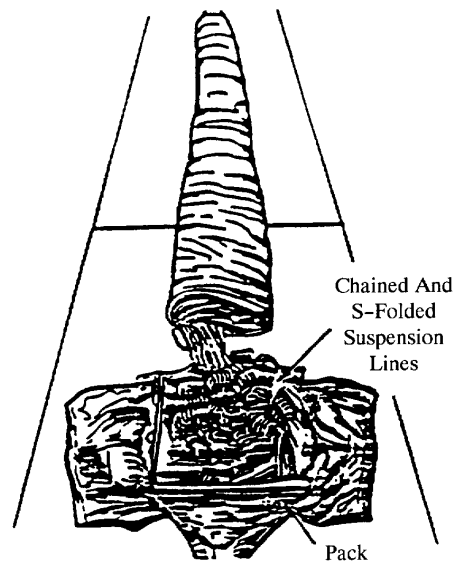

4. Place the lower end of the canopy on top of the S-folded suspension lines and locate the lower edge of the canopy skirt at the lower end of the pack.
5. Accordion fold the remaining canopy length neatly on top of the canopy lower end. Turn the canopy vent under the last fold.

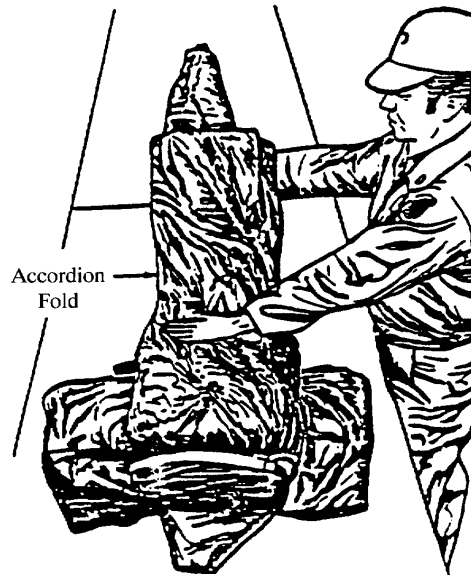

Accordion Folding The Canopy

6. Temporarily secure the folded canopy to the pack tray with available webbing or pack components.

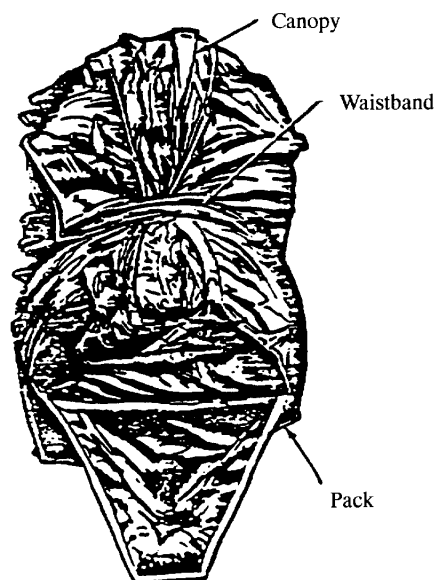

Folded Canopy Secured

7. Upon completion of the accordion folding process, place the folded parachute assembly in a suitable type container for storage.

Rigger Rolling. Personnel parachute assemblies will be rigger rolled prior to being sent to, or returned from, a parachute repair activity, for ease of handling and to prevent suspension line entanglement.

Rigger roll a parachute as follows:

1. Place the parachute in proper layout and apply partial tension.
2. Grasp the right and left suspension line groups. Using a fast circular motion, flip each of the two gore groups up and to the center radial seam. Tighten each gore group roll by hand; bring both rolled gore groups together at the center radial seam.

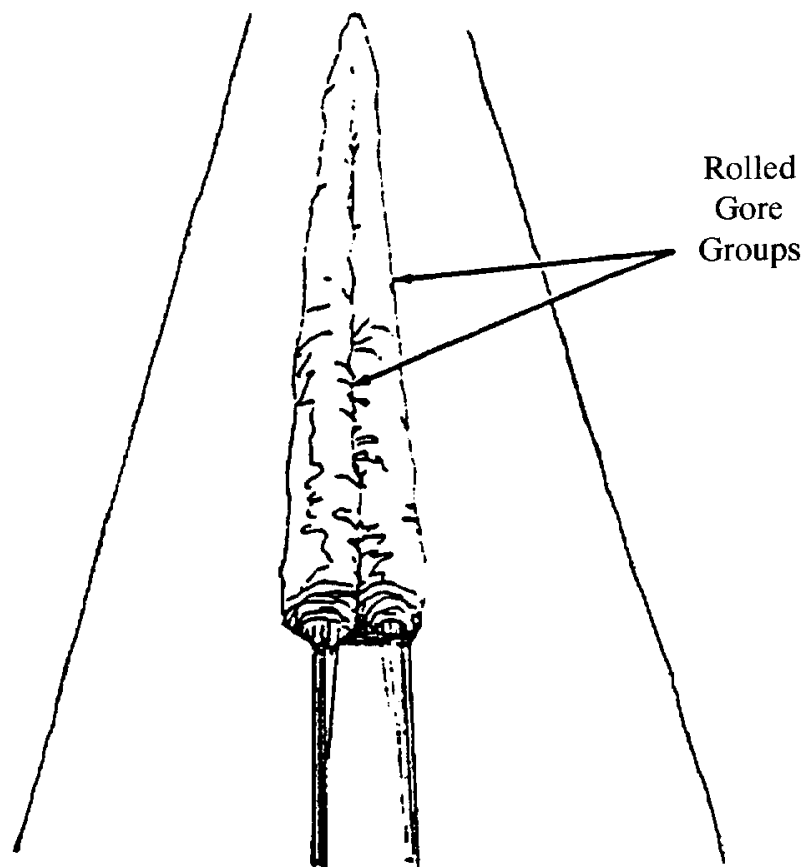

3. Release tension and disconnect the canopy vent from the vent-attaching device.
4. Fold the canopy vent down between the rolled gore groups to a point within 18-inches of the canopy skirt lower edge.

5. Beginning at the folded upper end of the canopy, roll the canopy tightly toward the canopy skirt. Ensure the width of the rolled canopy does not exceed the width of the applicable parachute pack tray.

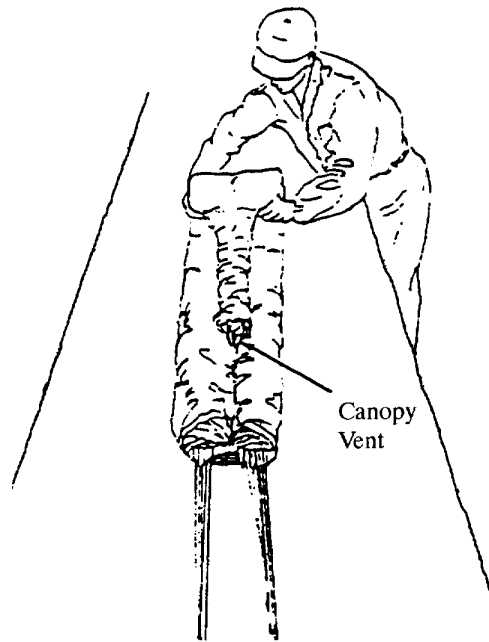

6. Continue rolling the canopy toward the lower end of the suspension lines and risers. If applicable, locate the lines and riser webbing around the center of the roll.

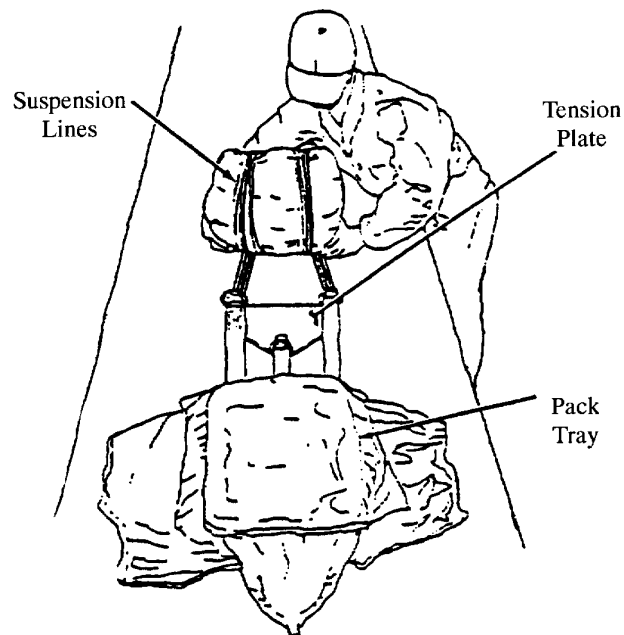

7. As applicable, disconnect the suspension lines/risers from the attaching device and place the rolled canopy assembly on top of the pack tray.
8. Secure the rolled canopy assembly within the confines of the pack tray, using either the straps or webbing of the pack tray, or a length of suitable type cord.

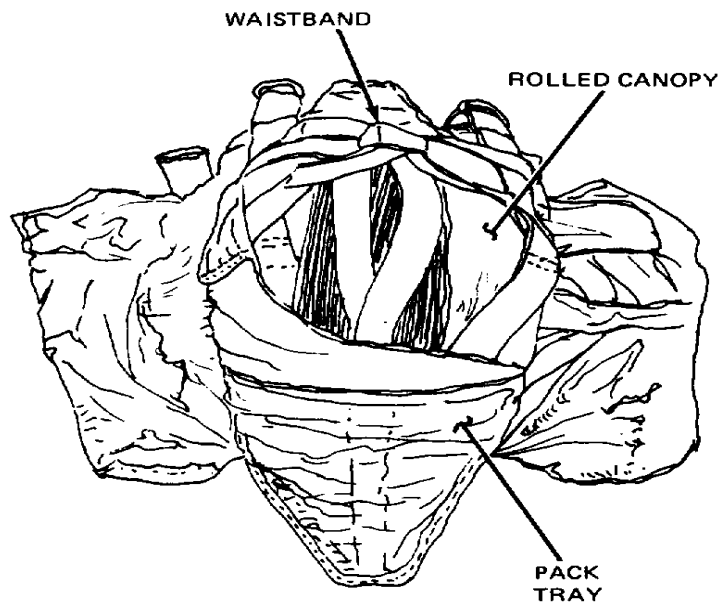

END OF WORK PACKAGE

CHAPTER 5
SUPPORTING INFORMATION
FOR
MC1-1C TROOP BACK PARACHUTE ASSEMBLY
MC1-1D TROOP BACK PARACHUTE ASSEMBLY

THIS PAGE INTENTIONALLY LEFT BLANK

SUPPORTING INFORMATION
MC1-1C/MC1-1D TROOP BACK PARACHUTE ASSEMBLY
REFERENCES

THIS WORKPACKAGE COVERS:

- Scope
 - Publication Indexes
 - Technical Manuals
 - Field Manuals
 - Army Regulations
 - Technical Bulletins
 - Forms
 - Air Force Technical Orders
 - Air Force Technical Order Forms
 - Marine Corps Forms
-

SCOPE

This appendix lists all forms, technical manuals, and miscellaneous publications referenced in this manual.

PUBLICATION INDEXES

The following publication indexes should be consulted frequently for the latest changes or revisions of references given in this work package, and for new publications relating to the material covered in this manual:

DA PAM

| | |
|--|----------------|
| Consolidated Index of Army Publications and Blank Forms | DA PAM 25-30 |
| Functional Users Manual for The Army Maintenance Management System (TAMMS) | DA PAM 738-750 |
| Functional Users Manual for The Army Maintenance Management System (Aviation) (TAMMSA) | DA PAM 738-751 |

TECHNICAL MANUALS

| | |
|---|---|
| General Maintenance of Parachutes and Other Airdrop Equipment | TM 10-1670-201-23/ T.O. 13C-1-41/ NAVAIR 13-1-17 |
| Ancillary Equipment For: Personnel Troop Parachute System Case, Parachutists, Individual Weapon, M-1950 | TM 10-1670-299-20&P/T.O. 14D1-2-470-2/NAVAIR 13-1-41 |
| Preservation, Packaging, Packing of Military Supplies and Equipment (Vols. 1 and 2) | TM 38-230-1 and TM 38-230-2 |
| Equipment Maintenance Forms and Procedures | TM 4700-15/1/ |
| Procedures for the Destruction of Air Delivery Equipment to Prevent Enemy Use | TM 43-0002-1/ T.O. 13C3-1-10/ NAVAIR 13-1-19 |

FIELD MANUALS

First Aid for Soldiers FM 4-25.11

ARMY REGULATIONS

Dictionary of United States Army Terms AR 310-25

Authorized Abbreviation and Brevity Codes and Acronyms AR 310-50

Packaging of Material AR 700-15

Army Material Maintenance Concepts and Policy and Retail Maintenance Operations AR 750-1

Air Drop, Parachute Recovery and Aircraft Personal Escape Systems AR 750-32

TECHNICAL BULLETINS

Maintenance Expenditure Limits for FSC Group 16, FSC Class 1670 TB 43-0002-43

FORMS

Parachute Log Record DA Form 3912

Equipment Inspection & Maintenance Worksheet DA Form 2404

AIR FORCE TECHNICAL ORDERS

Cleaning of Parachute Assemblies T.O. 14D1-1-2

Parachute Logs and Records T.O. DO-25-241

AIR FORCE TECHNICAL ORDER FORMS

Parachute Log AFTO 391

Parachute Repack Inspection and Component Card AFTO 392

MARINE CORPS FORMS

| | |
|--|--|
| Marine Corps Military Incentive Awards Program | MCO 1650.17F |
| Parachute History Record | NAV WPN CEN or NAV WPNS CL 13512/11 |
| Product Quality Deficiency Report (PQDR) | MCO 4855.10B |
| Recommended Changes to Technical Publications | NAVMC 10772 |

END OF WORK PACKAGE

THIS PAGE INTENTIONALLY LEFT BLANK

SUPPORTING INFORMATION
MC1-1C/MC1-1D TROOP BACK PARACHUTE ASSEMBLY
MAINTENANCE ALLOCATION CHART (MAC)

THIS WORKPACKAGE COVERS:

- Introduction
 - Maintenance Functions
 - Explanation of Columns in the MAC
 - Explanation of Columns in Tool and Test Equipment Requirements
 - Explanation of Column in Remarks
-

INTRODUCTION**The Army Maintenance System MAC**

This section provides a general explanation of all maintenance and repair functions authorized at various maintenance levels under the standard Army Maintenance System concept.

The Maintenance Allocation Chart (MAC) designates overall authority and responsibility for the performance of maintenance functions on the identified end item or component. The application of the maintenance functions to the end item or component will be consistent with the capacities and capabilities of the designated maintenance levels, which are shown in the MAC in column (4) as:

- Unit – includes two sub-columns, C (operator/crew) and O (unit) maintenance
- Direct Support – includes an F sub-column
- General Support – includes an H sub-column
- Depot – includes a sub-column

The tools and test equipment requirements (immediately following the MAC) list the tools and test equipment (both special tools and common tool sets) required for each maintenance function as referenced from the MAC.

The remarks (immediately following the tools and test equipment requirements) contain supplemental instructions and explanatory notes for a particular maintenance function.

MAINTENANCE FUNCTIONS

Maintenance functions will be limited to, and defined, as follows:

Inspect. To determine the serviceability of an item by comparing its physical, mechanical, and/or electrical characteristics with established standards through examination (e.g. by sight, sound, feel, etc.).

Test. To verify serviceability by measuring the mechanical, pneumatic, hydraulic, or electrical characteristics of an item and comparing those characteristics with prescribed standards.

Service. Operations, periodically required, to keep an item in proper operating condition, i.e., to clean (includes decontaminate, when required), to preserve, to drain, to paint, or to replenish fuel, lubricants, chemical fluids, or gases.

Adjust. To maintain or regulate, within prescribed limits, by bringing into proper or exact position, or by setting the operating characteristics to specified parameters.

Align. To adjust specified variable elements of an item to bring about optimum or desired performance.

Calibrate. To determine and cause corrections to be made or to be adjusted on instruments or test, measuring, and diagnostic equipments used in precision measurement. Consists of comparisons of two instruments, one of which is a certified standard of known accuracy, to detect and adjust any discrepancy in the accuracy of the instrument being compared.

Remove/Install. To remove and install the same item when required to perform service or other maintenance functions. Install may be the act of emplacing, seating, or fixing into position a spare, repair part, or module (component or assembly) in a manner to allow the proper functioning of an equipment or system.

Replace. To remove an unserviceable item and install a serviceable counterpart in its place. Replace is authorized by the MAC, and is shown as the 3rd position code of the Source, Maintenance, and Recoverability (SMR) code.

Repair. The application of maintenance services, including fault location/troubleshooting, removal/installation, and disassembly/assembly procedures, and maintenance actions to identify troubles and restore serviceability to an item by correcting specific damage, fault, malfunction, or failure in a part, subassembly, module (component or assembly), end item, or system.

Overhaul. The maintenance effort (service/action) prescribed to restore an item to a completely serviceable/operations condition, as required by maintenance standards in appropriate technical publications (i.e., DMWR). Overhaul is normally the highest degree of maintenance performed by the Army. Overhaul does not normally return an item to like new condition.

Rebuild. Consists of those services/actions necessary for the restoration of unserviceable equipment to a like new condition, in accordance with original manufacturing standards. Rebuild is the highest degree of materiel maintenance applied to Army equipment. The rebuild operation includes the act of returning to zero those age measurements (hours, miles, etc.) considered in classifying Army equipment/components.

EXPLANATION OF COLUMNS IN THE MAC, TABLE 1

Column 1, Group Number. Column 1 lists functional group code numbers, the purpose of which is to identify maintenance significant components, assemblies, subassemblies, and modules with the next higher assembly. End item group number shall be listed as 00.

Column 2, Component/Assembly. Column 2 contains the names of the components, assemblies, subassemblies, and modules for which maintenance is authorized.

Column 3, Maintenance Function. Column 3 lists the functions to be performed on the item listed in Column 2. (For detailed explanation of these functions, see the Maintenance Functions information detailed above.

Column 4, Maintenance Level. Column 4 specifies, by the listing of work-time in the appropriate sub column(s), the level of maintenance authorized to perform the function listed in Column 3. This figure represents the active time required to perform that maintenance function at the indicated level of maintenance. If the number of complexity of the tasks within the listed maintenance function varies at different maintenance levels, appropriate work-time figures will be shown for each level. The work-time figure represents the average time required to restore an item (assembly, subassembly, component, module, end item, or system) to a serviceable condition under typical field operating conditions.

This time includes preparation time (including any necessary disassembly/assembly time), troubleshooting/fault location time, and quality assurance/quality control time, in addition to the time required to perform the specific tasks identified for the maintenance functions authorized in the maintenance allocation chart. The symbol designations for the various maintenance levels are as follows:

- C - Operator or Crew
- O - Unit Maintenance
- F - Direct Support Maintenance
- H - General Support Maintenance
- D - Depot Maintenance

Column 5, Tools and Equipment. Column 5 specifies by code, those common tool sets (not individual tools) and special tools (Test, Measurement, and Diagnostic Equipment (TMDE)), and support equipment required to perform the designated function.

Column 6, Remarks. This column shall, when applicable, contain a letter code, in alphabetical order.

EXPLANATION OF COLUMNS IN TOOL AND TEST EQUIPMENT REQUIREMENTS, TABLE 2

Column 1, Reference Code. The tool and test equipment reference code correlates with a code used in the MAC, Table 1, Column 5.

Column 2, Maintenance Category. The lowest category of maintenance authorized to use the tool or test equipment.

Column 3, Nomenclature. Name or identification of the tool or test equipment.

Column 4, National Stock Number. The National stock number of the tool or test equipment.

Column 5, Tool Number. The manufacturer's part number.

EXPLANATION OF COLUMN IN REMARKS, TABLE 3

Column 1, Reference Code. The code recorded in column 6.

Column 2, Remarks. This column lists information pertinent to the maintenance function being performed as indicated in the MAC.

**Table 1. Maintenance Allocation Chart for the 35-Foot Diameter,
MC1-1C/MC1-1D Troop Back Parachute Assembly**

| (1) GROUP NUMBER | (2) COMPONENT/ASSEMBLY | (3) MAINTENANCE FUNCTION | (4) MAINTENANCE LEVEL | | | | | (5) TOOLS AND EQUIPMENT | (6) REMARKS |
|------------------------|----------------------------|--------------------------------|--------------------------|-------------------|--------------|-----|-------|-------------------------------|------------------------|
| | | | UNIT | | INTERMEDIATE | | DEPOT | | |
| | | | C | O | F | H | D | | |
| 00 | MC1-1C/MC1-1D Parachute | Inspect Service Test | | 1.0 1.0 | | | | Table 2 in this WP. | A, B, C, D, E, F, G |
| 01 | Canopy | Repair Replace | | 0.5 0.3 | | | | Table 2 in this WP. | A, B, C, E, F, G |
| 0101 | Bridle Loop | Repair Replace | | 0.1 0.3 | | | | | |
| 0102 | Vent Line | Repair Replace | | | 0.1 0.5 | | | | |
| 0103 | Upper Lateral Band | Repair | | 0.4 | | | | | |
| 0104 | Radial Seam | Repair | | 0.3 | | | | | |
| 0105 | Radial Tape | Replace | | | 1.0 | | | | |
| 0106 | Gore Section | Repair Replace | | 0.4 | | 1.0 | | | F |
| 0107 | Lower Lateral Band | Repair | | 0.4 | | | | | |
| 0108 | Pocket Band | Repair Replace | | 0.1 0.3 | | | | | |
| 0109 | V-Tab | Repair Replace | | 0.1 0.3 | | | | | |
| 0110 | Anti-Inversion Net | Inspect Repair Replace | | 0.1 0.3 0.8 | | | | | |
| 0111 | Suspension Line | Repair Replace | | 0.1 | | 0.8 | | | |
| 0112 | Control Line Bridle | Repair Replace | | 0.1 0.3 | | | | | |
| 0113 | Control Line | Repair Replace | | 0.2 0.3 | | | | | |
| 0114 | Connector Link | Repair Replace | | 0.2 0.3 | | | | | |
| 02 | Risers | Repair Replace | | 0.3 0.2 | | | | Table 2 in this WP. | A, C, E, G |
| 03 | Deployment Bag | Repair Replace | | 0.5 0.1 | | | | Table 2 in this WP. | B, C, E, G |
| 0301 | Reinforcing Webbing | Repair | | 0.2 | | | | | |
| 0302 | Locking Stow Loop Hood | Repair Replace | | 0.3 0.4 | | | | | |

**Table 1. Maintenance Allocation Chart for the 35-Foot Diameter,
MC1-1C/MC1-1C Troop Back Parachute Assembly - Continued**

| (1) GROUP NUMBER | (2) COMPONENT/ASSEMBLY | (3) MAINTENANCE FUNCTION | (4) MAINTENANCE LEVEL | | | | | (5) TOOLS AND EQUIPMENT | (6) REMARKS |
|------------------------|-----------------------------------|--------------------------------|--------------------------|------------|--------------|---|-------|-------------------------------|------------------|
| | | | UNIT | | INTERMEDIATE | | DEPOT | | |
| | | | C | O | F | H | D | | |
| 0303 | Tie-down Loop | Repair Replace | | 0.3 0.3 | | | | | |
| 0304 | Standard Static Line Assembly | Repair Replace | | 0.2 0.5 | | | | | |
| 0305 | Standard Static Line Extension | Replace | | 0.2 | | | | | |
| 04 | Universal Static Line | Repair Replace | | 0.0 0.2 | | | | | |
| 05 | Harness, Assembly | Repair Replace | | 0.5 0.4 | | | | Table 2 in this WP. | A, B, C, E, G |
| 0501 | Retainer Webbing | Replace | | 0.3 | | | | | |
| 0502 | Horizontal Back-strap | Replace | | 0.3 | | | | | |
| 0503 | Canopy Release Pad | Replace | | 0.4 | | | | | |
| 0504 | Canopy Release | Repair Replace | | 0.5 0.5 | | | | | |
| 0505 | Canopy Release Cable Loop | Repair | | 0.2 | | | | | |
| 0506 | Ejector Snap Pad | Replace | | 0.4 | | | | | |
| 06 | Pack Tray | Repair Replace | | 0.5 0.4 | | | | Table 2 in this WP. | B, C, E, G |
| 0601 | Back-strap Retainer | Replace | | 0.5 | | | | | |
| 0602 | Back-strap Keeper | Repair Replace | | 0.4 0.5 | | | | | |
| 0603 | Pack Closing Loop | Replace | | 0.2 | | | | | |
| 0604 | Retainer Band Keeper | Replace | | 0.3 | | | | | |
| 0605 | Waistband | Replace | | 0.4 | | | | | |
| 0606 | Waistband Adjuster Panel | Replace | | 0.4 | | | | | |

Table 2. Tool and Test Equipment Requirements for the 35-Foot Diameter, MC1-1C/MC1-1D Troop Back Parachute Assembly

| (1) TOOL or TEST EQUIPMENT REFERENCE CODE | (2) MAINTENANCE CATEGORY | (3) NOMENCLATURE | (4) NATIONAL NATO STOCK NUMBER | (5) PN TOOL NUMBER |
|---|--------------------------------|--|--------------------------------------|--------------------------|
| 1 | O | Anvil, Chuck Fastener | 5120-00-357-6181 | 9902 |
| 2 | O | Brush, Artist's | 8020-00-246-8502 | H-B-118 |
| 3 | O | Canopy Release (Repair) Kit | 1670-00-925-5615 | 100680 |
| 4 | O | Chuck | 5120-00-343-8214 | 9765 |
| 5 | O | Cutter, Double Bow, ½-inch | 5110-00-180-0923 | GG-P-833 |
| 6 | O | Cutter, Single Bow, ³ / ₁₆ -inch | 5110-00-180-0941 | GGG-P-4333 |
| 7 | O | Die | 5120-00-343-8213 | 9764 |
| 8 | O | File, 1-inch Flat | 5110-00-249-2850 | GGG-F-325 |
| 9 | O | Hammer, Ball Peen, 16-oz. | 5120-00-114-5499 | GGG-H-86 |
| 10 | O | Holder, Die, Fastener | 5120-00-357-6177 | 192 |
| 11 | O | Key, Socket Head Set (Allen Type) | 5120-00-729-6392 | GGG-K-275 |
| 12 | O | Kit, Bag | 8460-00-606-8366 | MIL-K-41835 |
| 13 | O | Knife | 5110-00-162-2205 | MIL-K-818C |
| 14 | O | Knife, Hot Metal | 3439-01-197-7656 | 4025 (78976) |
| 15 | O | Lead, Pig, 5-Pounds | 9650-00-264-5050 | QQ-C-40 |
| 16 | O | Line Separator | 1670-00-092-8661 | 11-1-3512 |
| 17 | O | Mallet, Rawhide | 5120-00-293-3397 | GGG-H-33 |
| 18 | O | Needle, Basting | 8315-00-281-9484 | FF-N-180 |
| 19 | O | Needle, Tacking | 8315-00-262-3733 | FF-N-180 |
| 20 | O | Packing Paddle | 1670-00-764-6381 | 11-1-152 |
| 21 | O | Packing Weight | 1670-00-375-9134 | 66C38599 |
| 22 | O | Plate, Tension | 1670-00-032-2705 | 11-1-99 |
| 23 | O | Pliers, Needle Nose | 5120-01-021-7473 | B107.13M |
| 24 | O | Pot, Melting, Electric | 5120-00-924-5213 | L-115 |
| 25 | O | Press, Hand Operated | 5120-00-880-0619 | A741 |
| 26 | O | Screwdriver, Flat-tip, ¼ X 6 | 5120-00-596-8653 | GGG-S-121 |
| 27 | O | Separator, Connector Link | 1670-00-072-4941 | MIL-S-43243 |
| 28 | O | Shears | 5110-00-223-6370 | GGG-S-00278 |
| 29 | O | Stow Hook | 1670-00-903-4570 | 11-1-343 |
| 30 | O | Tester, Spring, 0 to 80-lbs. (Scale) | 6635-00-705-5469 | 80D (11710) |
| 31 | O | Tool Kit, Canopy Release | 1670-01-319-6969 | 6038 |

**Table 3. Remarks for the 35-Foot
Diameter, MC1-1C/MC1-1D Troop Back Parachute Assembly**

| REFERENCE CODE | REMARKS/NOTES |
|-----------------------|---|
| A | During the final year of personnel canopy age life, only the organizational level maintenance is authorized by TB 43-0002-43. |
| B | Inspect is a technical-rigger type inspection; other inspections in WP 0006 00 and WP 0009 00. |
| C | Service includes cleaning and drying, shakeout and airing of equipment, and packing. |
| D | Service is the packing of parachutes. |
| E | Repair by restitching, darning, retacking, or restencilling the canopy panel. Repair at the unit maintenance level consists of darning, restitching, patching and the replacement of parts authorized for unit maintenance. |
| F | Direct support repair consists of replacing gore sections, suspension lines, and vent lines. |
| G | Test all fabrics and webbing material for salt-water contamination. |

END OF WORK PACKAGE

THIS PAGE INTENTIONALLY LEFT BLANK

**MC1-1C/MC1-1D TROOP BACK PARACHUTE ASSEMBLY
REPAIR PARTS AND SPECIAL TOOLS LIST (RPSTL), INTRODUCTION**

SCOPE

This manual lists and authorizes spare and repair parts; special tools; special test, measurement, and diagnostic equipment (TMDE); and other special support equipment required for performance of organizational, direct support, and general support maintenance of the 35-Foot Diameter, MC1-1C/MC1-1D Troop Back Parachute. It authorizes the requisitioning, issue, and disposition of spares, repair parts and special tools, as indicated by the Source, Maintenance and Recoverability (SMR) codes.

GENERAL INFORMATION

This Repair Parts and Special Tools List is divided into the following sections:

WP 0043 00, Repair Parts List. A list of spares and repair parts authorized by this RPSTL is for use in the performance of maintenance. The list also includes parts that must be removed for replacement of the authorized parts. Parts lists are composed of functional groups in ascending alphanumeric sequence, with the parts in each group listed in ascending figure, and item, number sequence. Bulk materials are listed.

Special Tools List. (Not Applicable). No special tools are required to assemble the MC1-1C/MC1-1D, 35-Foor Diameter Parachute. Common tools are listed in WP 0042 00 because they are required for performance of packing and maintenance procedures/tasks. These tools are authorized under Chapter 1, WP 0001 00 of this manual.

Cross Reference Indexes. A list, in National Item Identification Number (NIIN) sequence, of all National Stock Numbers (NSN) appearing in the listings (WP 0053 00), followed by a list in alphanumeric sequence of all part numbers appearing in the listings (WP 0054 00). National stock numbers and part numbers are cross-referenced to each illustration figure and item number appearance.

EXPLANATION OF COLUMNS

Column 1, Item No. Indicates the number used to identify items called out in the illustration.

Column 2, SMR Code. The Source, Maintenance, and Recoverability (SMR) code is a 5-position code containing supply/requisitioning information, maintenance category authorization criteria, and disposition instructions, as shown in the following breakout:

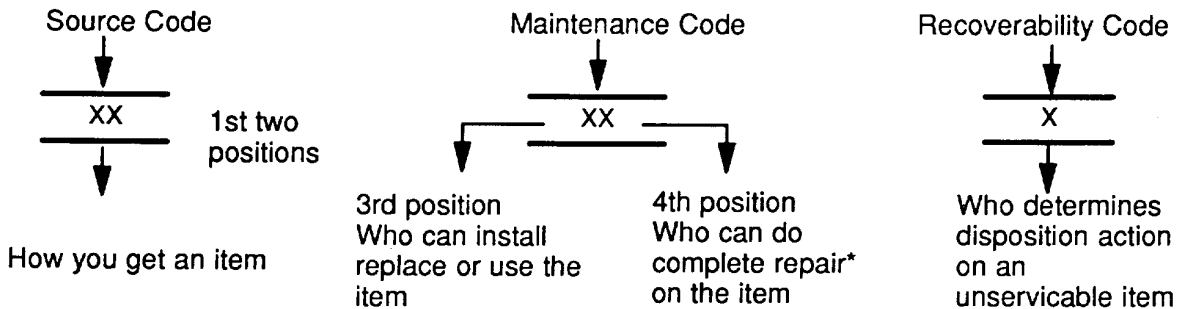

*Complete Repair: Maintenance capacity, capability, and authority to perform all the corrective maintenance tasks of the REPAIR function in a use/user environment in order to restore serviceability to a failed item.

Source Code. The source code tells you how to get an item needed for maintenance, repair, or overhaul of an end item/equipment. Source codes are always the first and second positions of the SMR code. Explanations of source codes follow:

| SOURCE CODE | EXPLANATION |
|--|--|
| PA PB PC PD PE PF PG | Stocked items: Use the applicable NSN to request/requisition items with these source codes. They are authorized to the category indicated by the code entered in the 3 rd position of the SMR code. |
| KD KF KF | Items with these codes are not to be requested/requisitioned individually. They are part of a kit which is authorized to the maintenance category indicated in the 3 rd position of the SMR code. The complete kit must be requisitioned and applied. |
| MO – (Made at org/AVUM Level) MF – (Made at DS/AVUM Level) MH – (Made at GS Level) ML – (Made at Specialized Repair Act (SRA)) MD – (Made at Depot) | Items with these codes are not to be requested/requisitioned individually. They must be made from bulk material which is identified by the part number in the DESCRIPTION and USABLE ON CODE (UOC) column and listed in the Bulk Material group of the repair parts list in the RPSTL. If the item is authorized to you by the 3 rd position code of the SMR code, but the source code indicates it is made at a higher level, order the item from the higher level of maintenance. |
| AO – (Assembled by org/AVUM Level) AF – (Assembled by DS/AVIM Level) AH – (Assembled by GS Category) AL – (Assembled by SRA) AD – (Assembled by Depot) | Items with these codes are not to be requested/requisitioned individually. The parts that make up the assembled item must be requisitioned or fabricated and assembled at the level of maintenance indicated by the source code. If the 3 rd position code of the SMR code authorizes you to replace the item, but the source code indicates the item is assembled at a higher level, order the item from the higher level of maintenance. |
| XA - | Do not requisition an XA-coded item. Order its next higher assembly. (Also, refer to the NOTE below.) |
| XB - | If and XB-coded item is not available from salvage, order it using the CAGEC and the given part number. |
| XC - | The installation drawing, diagram, instruction sheet, and field service drawing that is identified by manufacturer's part number. |
| XD - | Item is not stocked. Order an XD-coded item through normal supply channels using the CAGEC and the part number given, if no NSN is available. |

NOTE

Cannibalization or controlled exchanged, when authorized, may be used as a source of supply for items with the above source codes, except for those source coded XA or those aircraft support item restricted by requirements of AR 750-1.

Maintenance Code. Maintenance codes tell you the level(s) of maintenance authorized to USE and REPAIR support items. The maintenance codes are entered in the third and fourth positions of the SMR Code as follow:

Third position. The maintenance code entered in the third position tells you the lowest maintenance level authorized to remove, replace, and use an item. The maintenance code entered in the third position will indicate authorization to one of the following levels of maintenance.

| MAINTENANCE CODE | APPLICATION/EXPLANATION |
|------------------|---|
| C - | Crew or operator maintenance done within organizational or aviation unit maintenance. |
| O - | Organizational or aviation unit category can remove, replace, and use the item. |
| F - | Direct support or aviation intermediate level can remove, replace, and use the item. |
| H - | General Support level can remove, replace, and use the item. |
| L - | Specialized repair activity can remove, replace, and use the item. |
| D - | Depot level can remove, replace, and use the item. |

Fourth position. The maintenance code entered in the fourth position tells whether or not the item is to be repaired and identifies the lowest maintenance level with the capability to do complete repair (i.e., perform all authorized repair functions.) Some limited repair may be done on the item at a lower level of maintenance, if authorized by the Maintenance Allocation Chart (MAC) and SMR code. This position will contain one of the following maintenance codes.

| MAINTENANCE CODE | APPLICATION/EXPLANATION |
|------------------|--|
| O - | Organizational (or aviation unit) is the lowest level that can do complete repair of the item. |
| F - | Direct support (or aviation intermediate) is the lowest level that can do complete repair of the item. |

MAINTENANCE CODE - Continued**APPLICATION/ EXPLANATION - Continued**

| | |
|-----|---|
| H - | General support is the lowest level that can do complete repair of the item. |
| L - | Specialized repair activity (designate the specialized repair activity) is the lowest level that can do complete repair of the item. |
| D - | Depot is the lowest level that can do complete repair of the item. |
| Z - | Non-repairable. No repair is authorized. |
| B - | No repair is authorized. (No parts or special tools are authorized for the maintenance of a B-coded item.) However, the item may be reconditioned by adjusting, lubricating, etc., at the user level. |

Recoverability code. Recoverability codes are assigned to items to indicate the disposition action on unserviceable items. The recoverability code is entered in the **fifth position** of the SMR code as follows:

RECOVERABILITY CODE**APPLICATION/EXPLANATION**

| | |
|-----|---|
| Z - | Non-repairable item. When unserviceable, condemn and dispose of the item at the level of maintenance shown in the 3 rd position of the SMR Code. |
| O - | Repairable item. When uneconomically repairable, condemn and dispose of the item at organizational or aviation unit level. |
| F - | Repairable item. When uneconomically repairable, condemn and dispose of the item at the direct support or aviation intermediate level. |
| H - | Repairable item. When uneconomically repairable, condemn and dispose of the item at the general support level. |
| D - | Repairable item. When beyond the lower level repair capability, return to depot. Condemnation and disposal of item not authorized below depot level. |

RECOVERABILITY CODE - Continued**APPLICATION/EXPLANATION - Continued**

L -

Repairable item. Condemnation and disposal not authorized below Specialized Repair Activity (SRA).

A -

Item requires special handling or condemnation procedures because of specific reasons (e.g., precious metal content, high dollar value, critical material or hazardous material). Refer to appropriate manuals/directives for specific instructions.

Column 3, CAGE Code. The Commercial and Government Entity Code (CAGEC) is a 5-digit numeric code that is used to identify the manufacturer, distributor, or Government agency, that supplies the item.

Column 4, Part Number. Indicates the primary number used by the manufacturer (individual, company, firm, corporation, or Government activity), which controls the design and characteristics of the item by means of its engineering drawings, specifications, standards, and inspection requirements to identify an item or range of items.

NOTE

When you use an NSN to requisition an item, the item you receive may have a different part number from the part ordered.

Column 5, Description and Usable on Code (UOC). This column includes the following information:

1. The Federal item name and, when repaired, a minimum description to identify the item.
2. The physical security classification of the item is indicated by the parenthetical entry, (insert applicable physical security classification abbreviation, e.g., Phy Sec CI (C) – Confidential, Phy Sec CI (S) Secret, Phy Sec CI (T) – Top Secret.
3. Items that are included in kits and sets are listed below the name of the kit or set.
4. Spare/repair parts that make up an assembled item are listed immediately following the assembled item line entry.
5. Part numbers for bulk materials are referenced in this column in the line item entry for the item to be manufactured/fabricated.
6. When the item is not used will all serial numbers of the same model, the effective serial numbers are shown on the last line(s) of the description (before UOC).
7. The usable on code, when applicable (see the “SPECIAL INFORMATION” paragraph below).

8. In the Special Tools List section, the basis of issue (BOI) appears as the last line(s) in the entry for each special tool, special TMDE, and other special support equipment. When density of equipment supported exceeds density spread indicated in the BOI, the total authorization is increased proportionately.
9. The statement END OF FIGURE appears just below the last item description in Column 5 for a given figure.

Column 6, QTY. The QTY (quantity per figure column) indicates the quantity of the item used in the breakout shown on the illustration figure, which is prepared for a functional group, sub functional group, or an assembly. A "V" appearing in the column, in lieu of a quantity, indicates that the quantity is variable and may vary from application to application.

SPECIAL INFORMATION

The Usable on Code title appears in the lower right corner of column (5), Description. Usable on codes are shown in the right-hand margin of the description column. Identification of the usable on codes used in the RPSTL are:

| Code: | Used on: |
|--------------|------------------|
| EPX | 1670-01-262-2359 |
| FRC | 1670-01-487-0777 |

Bulk materials required to manufacture items are listed in the Bulk Material group of this manual. NSNs for bulk materials are also referenced in the description column of the line item entry for the item to be manufactured/fabricated. Detailed manufacturing instructions for items source coded to be manufactured or fabricated are found in this manual.

Detailed assembly instructions for items source coded to be assembled from component spare/repair parts are found in this manual. Items that make up the assembly are listed immediately following the assembled item entry.

Line item entries for repair part kits and sets appear as the last entries in the repair part listing for the figure in which their parts are listed as repair parts.

Items that have the word Bulk in the figure number column will have an index number shown in the item number column. This index number is furnished for use as a cross-reference between the National Stock Number/Part Number Index and the bulk material list.

In the repair parts list, some items are indented to show that they are components of the item under which they are indented.

EXPLANATION OF COLUMNS**National Stock Number (NSN) Index.**

1. *Stock number column.* This column lists the NSN by National Item Identification Number (NIIN) sequence. The NIIN consists of the last nine digits of the NSN, i.e.

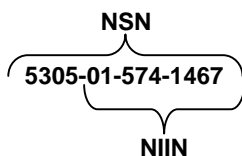

When using this column to locate an item, ignore the first 4 digits of the NSN. However, the complete NSN should be used when ordering items by stock number.

2. *Fig. column.* This column lists the number of the figure where the item is identified/located.
3. *Item column.* The item number identifies the item associated with the figure listed in the adjacent Fig. column. This item is also identified by the NSN listed on the same line.

Part Number Index. Part numbers in this index are listed by part number in ascending alphanumeric sequence (i.e., vertical arrangement of letter and number combination which places the first letter or digit of each group in order A through Z, followed by the numbers 0 through 9, and each following letter or digit in like order).

1. *CAGEC column.* The Commercial and Government Entity Code is a 5-digit numeric code used to identify the manufacturer, distributor, or Government agency, etc., that supplies the item.
2. *Part number column.* Indicates the primary number used by the manufacturer (individual, firm, corporation, or Government activity), that controls the design and characteristics of the item by means of its engineering drawings, specifications, standards, and inspection requirements to identify an item or range of items.
3. *Stock number column.* This column lists the NSN for the associated part number and manufacturer identified in the part number and CAGEC columns to the left.
4. *Fig. column.* This column lists the number of the figure where the item is identified/located.
5. *Item column.* The item number is that number assigned to the item as it appears in the figure referenced in the adjacent figure number column.

HOW TO LOCATE REPAIR PARTS**When National Stock Number or Part Number is Not Known.**

1. *First.* Using the table of contents, determine the functional group or sub-functional group to which the item belongs. This is necessary since the figures are prepared for functional groups and sub-functional groups, and listings are divided into the same groups.
2. *Second.* Find the item on the figure covering the functional group or sub-functional group to which the item belongs.
3. *Third.* Identify the item on the figure and note the item number of the item.

-
4. *Fourth.* Refer to the Repair Parts List for the figure to find the line item entry for the item number noted on the figure.

When National Stock Number or Part Number is Known.

1. *First.* Using the Index of National Stock Numbers and Part Numbers, find the pertinent National Stock Number or part number. The NSN index is in the National Item Identification Number (NIIN) *sequence. The part numbers in the Part Number index are listed in ascending alphanumeric sequence. Both indexes cross-reference you to the illustration figure and item number of the item you are looking for.

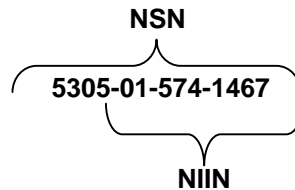

*The NIIN consists of the last 9 digits of the NSN, as shown above.

2. *Second.* After finding the figure and item number, verify that the item is the one you're looking for, then locate the item number in the repair parts list for the figure.

END OF WORK PACKAGE

THIS PAGE INTENTIONALLY LEFT BLANK

GROUP 00 MC1-1C/MC1-1D TROOP BACK PERSONNEL PARACHUTE

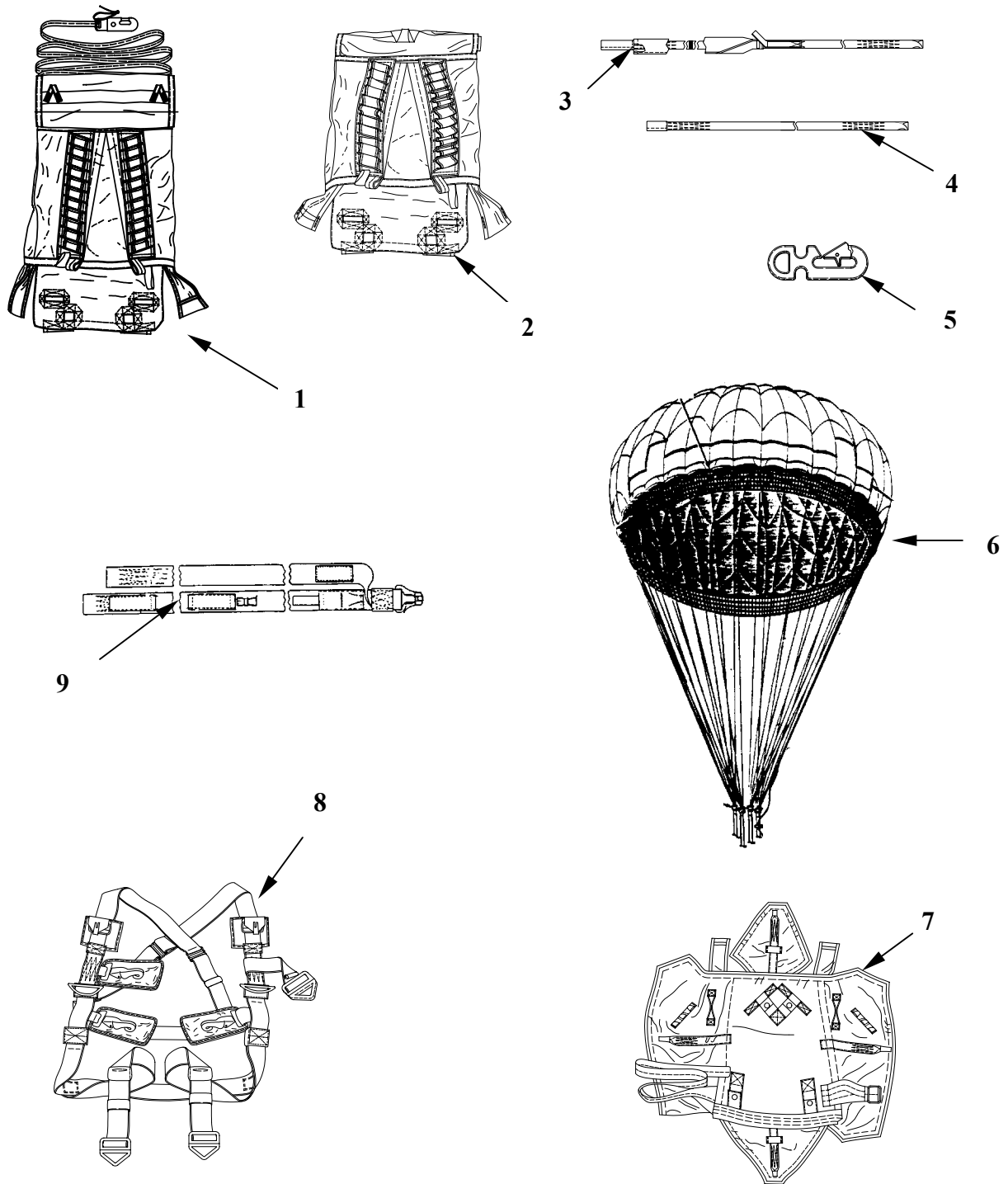

Figure 1. MC1-1C/MC1-1D Troop Back Personnel Parachute

**GROUP 00 MC1-1C/MC1-1D TROOP BACK PERSONNEL PARACHUTE
REPAIR PARTS LIST**

| (1) ITEM NO. | (2) SMR CODE | (3) CAGEC | (4) PART NO. | (5) DESCRIPTION AND USABLE ON CODES (UOC) | (6) QTY |
|--|-----------------|--------------|-----------------|--|------------|
| Group 00, MC1-1C/MC1-1D Troop Back Personnel Parachute Figure 1, MC1-1C/MC1-1D, Troop Back Personnel Parachute, 11-1-900-2/11-1-900-3 | | | | | |
| 1 | PAOOO | 98750 | 56D6276 | Bag, Deployment, Standard UOC: EPX/FRD | 1 |
| 2 | PAOOO | 81337 | 11-1-6994-1 | Bag, Deployment, USL UOC: EPX/FRD | 1 |
| 3 | PAOZZ | 81337 | 11-1-6993-1 | Line, Static, USL UOC: EPX/FRD | 1 |
| 4 | PAOZZ | 81337 | 11-1-6993-2 | Line, Static, USL Ext UOC: EPX/FRD | 1 |
| 5 | PAOZZ | 81337 | 11-1-6991-1 | Snaphook, USL UOC: EPX/FRD | 1 |
| 6 | PAOFF | 81337 | 11-1-1501-3 | Canopy, 35-FT., W/ Net, MC1-1C/MC1-1D UOC: EPX/FRD | 1 |
| 7 | PAOOO | 81337 | 62J4342 | Pack, Personnel UOC: EPX/FRD | 1 |
| 8 | PCOOO | 81337 | 11-1-2143-1 | Harness, Personnel UOC: EPX/FRD | 1 |
| 9 | PAOOZ | 81337 | 11-1-2149-1 | Riser Extension UOC: EPX/FRD | 2 |
| END OF FIGURE | | | | | |

THIS PAGE INTENTIONALLY LEFT BLANK

THIS PAGE INTENTIONALLY LEFT BLANK

GROUP 01 PERSONNEL CANOPY WITH NET AND ORIFICE

DETAIL A

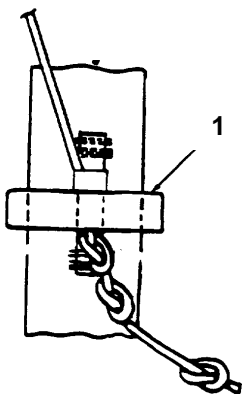

DETAIL B

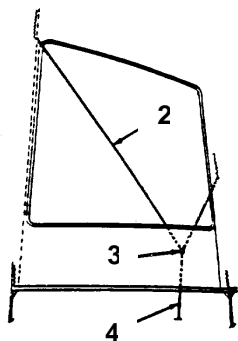

DETAIL C

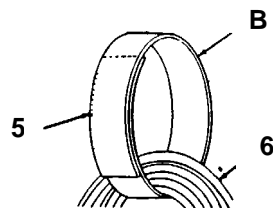

DETAIL D

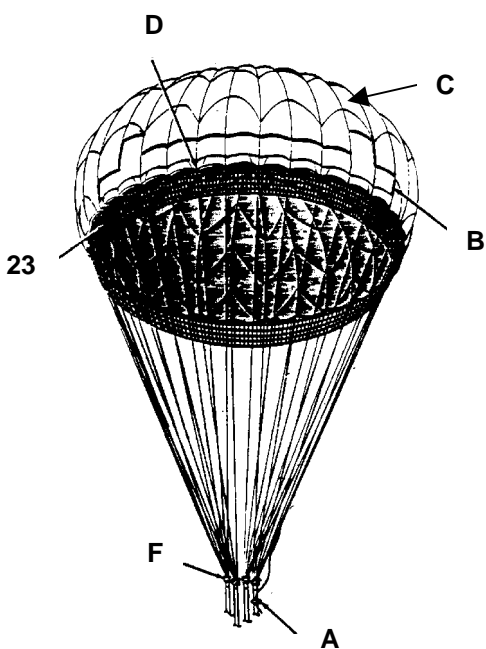
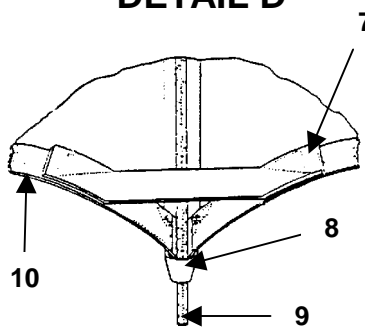

DETAIL E

Optional

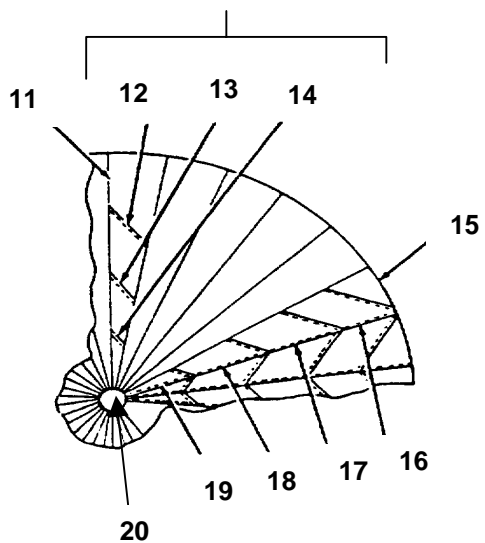

DETAIL F

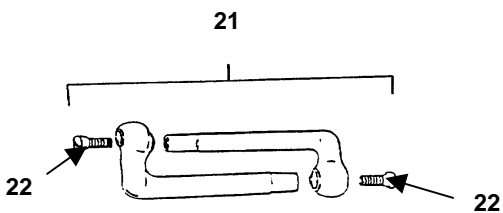

Figure 2. MC1-1C/MC1-1D Personnel Canopy With Net

**GROUP 01 PERSONNEL CANOPY WITH NET AND ORIFICE
REPAIR PARTS LIST**

| (1) ITEM NO. | (2) SMR CODE | (3) CAGEC | (4) PART NO. | (5) DESCRIPTION AND USABLE ON CODES (UOC) | (6) QTY |
|---|-----------------|--------------|-----------------|--|------------|
| Group 01, MC1-1C/MC1-1D Personnel Canopy W/ Net and Orifice Figure 2, MC1-1C/MC1-1D Personnel Canopy W/ Net and Orifice, 11-1-1501-3 | | | | | |
| 1 | PAOZZ | 58536 | A-A-1975 | Dowel, Hardwood (Toggle), UOC: EPX/FRD | 2 |
| 2 | MOOOO | 98750 | 68K147-21 | Control Line Bridle, Make From P/N PIA-C-5040, Type II, Thread Nylon, V-T- 295, Type I, CL A, OD, Size E, UOC: EPX/FRD | 2 |
| 3 | PAOZZ | 96906 | PS27762-1 | Reefing Ring, Parachute, UOC: EPX/FRD | 2 |
| 4 | MOOOO | 98750 | 68K147-20 | Control Line, Make From Cord, Nylon, P/N PIA-C- 5040, Type II, OG, UOC: EPX/FRD | 2 |
| 5 | MOOZZ | 98750 | 68K147-17 | Bridle Loop, Make From Webbing, Nylon, P/N PIA- W-4088 Type VII, OD Thread, Nylon P/N V-T-295 Type I CL A Size 6, Natural, UOC: EPX/FRD | 1 |
| 6 | MFFFF | 98750 | 68K147-15 | Vent Line, Make From Cord, P/N PIA-C-5040, Type II, OG Thread, Nylon, P/N V-T-295, Type I, CL A, Size E, Natural, UOC: EPX/FRD | 15 |
| 7 | MOOOO | 98750 | 68K147-22 | Pocket Band, Make From Tape, P/N PIA-T-1001, Type I, OG 1-in.-wide, Thread Nylon, P/N V-T-295, Type I, CL A, Natural, UOC: EPX/FRD | 15 |

**GROUP 01 PERSONNEL CANOPY WITH NET AND ORIFICE
REPAIR PARTS LIST**

| (1) ITEM NO. | (2) SMR CODE | (3) CAGEC | (4) PART NO. | (5) DESCRIPTION AND USABLE ON CODES (UOC) | (6) QTY |
|--------------------|-----------------|--------------|-----------------|--|------------|
| 8 | MOOOO | 98750 | 68K147-19 | V-Tab, Make From Webbing, Nylon, P/N PIA-W-4088, Type I, 9/16-in.-wide, Thread Nylon, P/N V-T-295, Type I, CL A, Size E, Natural, UOC: EPX/FRD | 30 |
| 9 | MFFFF | 98750 | 68K147-18 | Suspension Line, Make From Cord, P/N PIA-C-5040, Type II, OD, Thread Nylon, P/N V-T-295, Type I, CL A, Size E, Natural, UOC: EPX/FRD | 30 |
| 10 | MOOOO | 98750 | 68K147 | Lower Lateral Band, Make From Tape, P/N PIA-T-1001, Type I, OG 1-in.-wide, Thread Nylon, P/N V-T-295, Type I, CL A, Natural, UOC: EPX/FRD | 1 |
| 11 | MFFOF | 81337 | 11-1-2674-1 | Gore, Make From Cloth, Parachute, Low Permeability, Type I, P/N PIA-C-44378C, Type I, 36-in.-wide, Green, Thread Nylon, P/N V-T-295, Type I, CL A, Size E, Natural, UOC: EPX/FRD | 30 |
| 12 | MFFOF | 81337 | 11-1-2674-2 | Gore Section, Make From Cloth, Parachute, Low Permeability, Type I, PIA-C-44378C, Type I, 36-in.-wide, Green, Thread Nylon, P/N V-T-295, Type I, CL A, Size E, Natural, UOC: EPX/FRD | 30 |
| 13 | MFFOF | 81337 | 11-1-2674-3 | Gore Section, Make From Cloth, Parachute, Low Permeability, Nylon, P/N PIA-C-44378C, Type I, 36-in.-wide, Green Thread Nylon, P/N V-T-295, Type I, CL A, Size E, Natural, UOC: EPX/FRD | 30 |

**GROUP 01 PERSONNEL CANOPY WITH NET AND ORIFICE
REPAIR PARTS LIST**

| (1) ITEM NO. | (2) SMR CODE | (3) CAGEC | (4) PART NO. | (5) DESCRIPTION AND USABLE ON CODES (UOC) | (6) QTY |
|--------------------|-----------------|--------------|-----------------|---|------------|
| 14 | MFFOF | 81337 | 11-1-2674-4 | Gore Section, Make From Cloth, Parachute, Low Permeability, Nylon, P/N PIA-C-44378C, Type I, 36-in.-wide, Green, Thread Nylon, P/N V-5-295, Type I, CL A, Size E, Natural, UOC: EPX/FRD | 30 |
| 15 | MFFOF | 98750 | 58H6361-1 | Gore, Make From Cloth, Parachute, Low Permeability, P/N PIA-C-44378C, Type I, OD 36-in.-wide, Green, Thread Nylon, P/N V-T-295, Type I, CL A, Size E, Natural, UOC: EPX/FRD | 30 |
| 16 | MFFOF | 98750 | 58H6361-2 | Gore, Make From Cloth, Parachute, Low Permeability, P/N PIA-C-44378C, Type I, OD 36-in.-wide, Green, Thread Nylon, P/N V-T-295, Type I, CL A, Size E, Natural, UOC: EPX/FRD | 30 |
| 17 | MFFOF | 98750 | 58H6361-3 | Gore, Make From Cloth, Parachute, Low Permeability, P/N PIA-C-44378C, Type I, OD 36-in.-wide, Green, Thread Nylon, P/N V-T-295, Type I, CL A, Size E, Natural, UOC: EPX/FRD | 30 |
| 18 | MFFOF | 98750 | 58H6361-4 | Gore, Make From Cloth, Parachute, Low Permeability, P/N PIA-C-44378C, Type I, OD 36-in.-wide; Thread Nylon, P/N V-T-295, Type I, CL A, Size E, Natural, UOC: EPX/FRD | 30 |
| 19 | MFFOF | 98750 | 58H6361-5 | Gore, Make From Cloth, P/N MIL-C-7020, Type I, OD 36-in.-wide, Thread Nylon, P/N V-T-295, Type I, CL A, Size E, Natural, UOC: EPX/FRD | 30 |

**GROUP 01 PERSONNEL CANOPY WITH NET AND ORIFICE
REPAIR PARTS LIST**

| (1) ITEM NO. | (2) SMR CODE | (3) CAGEC | (4) PART NO. | (5) DESCRIPTION AND USABLE ON CODES (UOC) | (6) QTY |
|----------------------|-----------------|--------------|-----------------|--|------------|
| 20 | MOOOO | 98750 | 68K147 | Upper Lateral Band, Make From Webbing, P/N PIA-W-5625, 1-in.-wide, Green Thread, Nylon, P/N V-T-295, Type I, CL A, Size E, Natural, UOC: EPX/FRD | 1 |
| 21 | PAOZZ | 96906 | PS22002-1 | Link, Parachute, UOC: EPX/FRD | 4 |
| 22 | PAOZZ | 96906 | PS22002-7 | Screw, UOC: EPX/FRD | 8 |
| 23 | PAOZZ | 81349 | MIL-C-43805 | Cloth, Netting, UOC: EPX/FRD | YD |
| END OF FIGURE | | | | | |

THIS PAGE INTENTIONALLY LEFT BLANK

GROUP 02 RISER EXTENSION

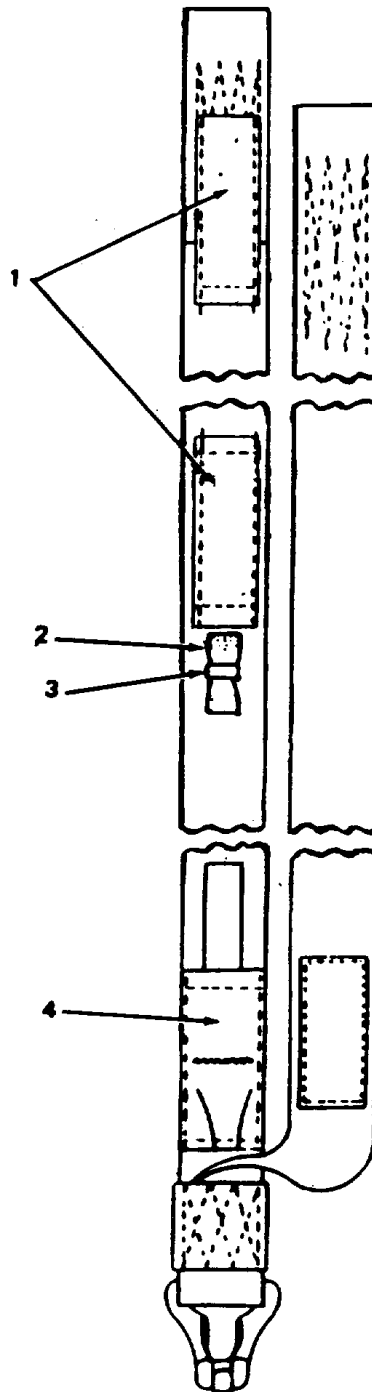

Figure 3. Riser Extension

**GROUP 02 RISER EXTENSION
REPAIR PARTS LIST**

| (1) ITEM NO. | (2) SMR CODE | (3) CAGEC | (4) PART NO. | (5) DESCRIPTION AND USABLE ON CODES (UOC) | (6) QTY |
|---|-----------------|--------------|-----------------|---|------------|
| Group 02, Riser Extension Figure 3, Riser Extension, 11-1-2149-1 | | | | | |
| 1 | MOOOO | 81337 | 11-1-2149 | Control Line Channel, Make From Tape, Nylon, P/N PIA-T-5038, Type III, 1½-in.-wide, OD, Thread, Nylon, P/N V-T-295, Type I, CL A, OD, Size E, UOC: EPX/FRD | 4 |
| 2 | MOOOO | 81337 | 11-1-2149 | Guide Ring Retainer G Strap, Make From Webbing, Nylon, P/N PIA-W-4088, Type I, CL I, OD 7, Thread, Nylon, P/N V-T-295, Type I, CL A, OD, Size E, UOC: EPX/FRD | |
| 3 | PAOZZ | 96906 | PS27762-1 | Ring Reefing Parachute, UOC: EPX/FRD | 2 |
| 4 | MOOOO | 81337 | 11-1-2149 | Log Record Pocket, Make From Cloth, Nylon, P/N MIL-C-7219 TY III OG 106, Thread Nylon, P/N V-T-295, TY I CL A OD, Size E, UOC: EPX/FRD | 1 |
| END OF FIGURE | | | | | |

THIS PAGE INTENTIONALLY LEFT BLANK

THIS PAGE INTENTIONALLY LEFT BLANK

GROUP 03 STANDARD DEPLOYMENT BAG

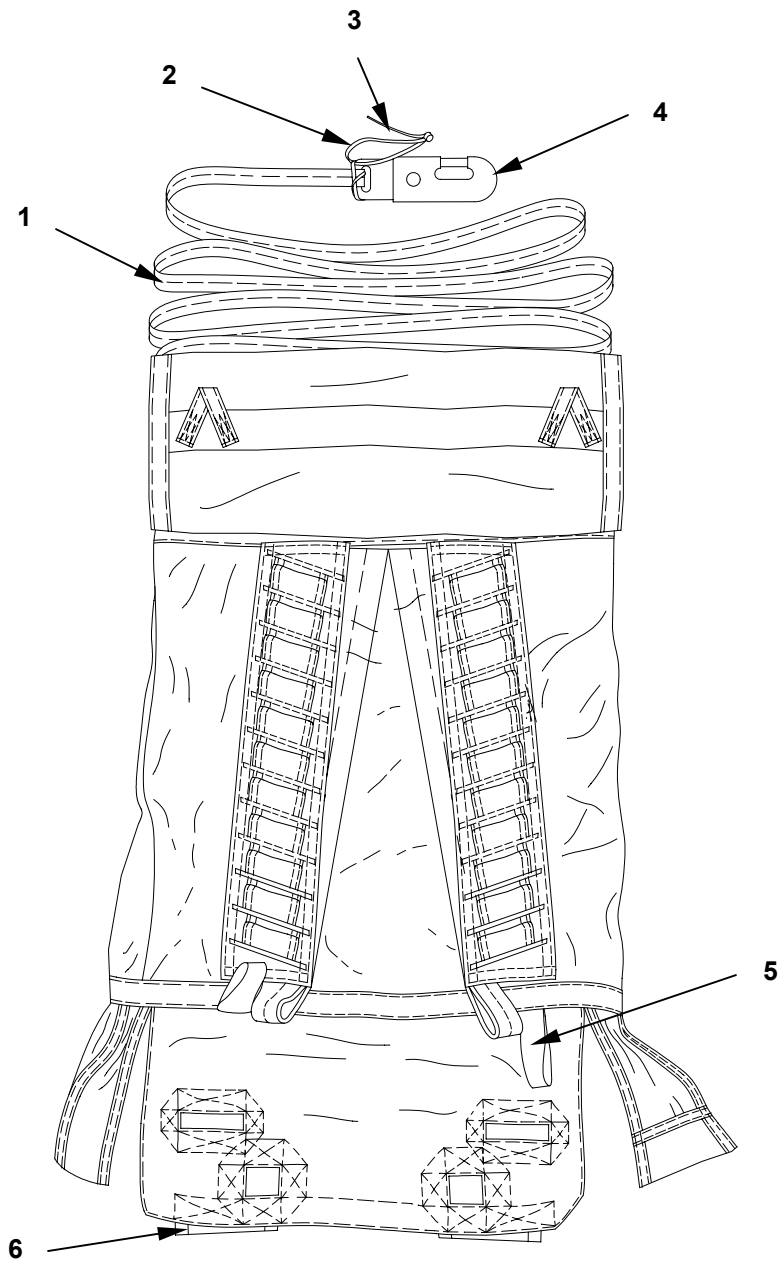

Figure 4. Standard Deployment Bag

**GROUP 03 STANDARD DEPLOYMENT BAG
REPAIR PARTS LIST**

| (1) ITEM NO. | (2) SMR CODE | (3) CAGEC | (4) PART NO. | (5) DESCRIPTION AND USABLE ON CODES (UOC) | (6) QTY |
|---|-----------------|--------------|-----------------|--|------------|
| Group 03, Standard Deployment Bag Figure 4, Standard Deployment Bag, 56D6276 | | | | | |
| 1 | PAOZZ | 98750 | 55D6481-20 | Static Line, Standard, Personnel Parachute, UOC: EPX/FRD | 1 |
| 2 | MOOOO | 98750 | 55D6481-5 | Lanyard, Make From Cord Nylon, P/N PIA-C-5040 OG Type III, UOC: EPX/FRD | 1 |
| 3 | MOOZZ | 98750 | 55B6261 | Safety Pin, Make From Wire Steel, Corrosion Resistant, P/N QQ-W-423, Composition FS430, Type II, Cord A, Form I, UOC: EPX/FRD | 1 |
| 4 | PAOZZ | 96906 | PS70120 | Snap Hook, Standard, UOC: EPX/FRD | 1 |
| 5 | MOOZZ | 81337 | 11-1-2594-18 | Tie-down Loop, Make From Webbing Nylon, P/N PIA- W-4088 Type I, 9/16-in.- wide, Thread Nylon, P/N V- T-295, Type I, CL A, Size E, Natural, UOC: EPX/FRD | 2 |
| 6 | MOOZZ | 81337 | 11-1-2594-5 | Locking Stow Loop Hood, Make From Cloth Sateen, P/N MIL-C-10296, Class 1 OG Thread, P/N V-T-295 Type I, CL A, Size E, Natural, UOC: EPX/FRD | 2 |
| END OF FIGURE | | | | | |

THIS PAGE INTENTIONALLY LEFT BLANK

THIS PAGE INTENTIONALLY LEFT BLANK

GROUP 04 UNIVERSAL STATIC LINE

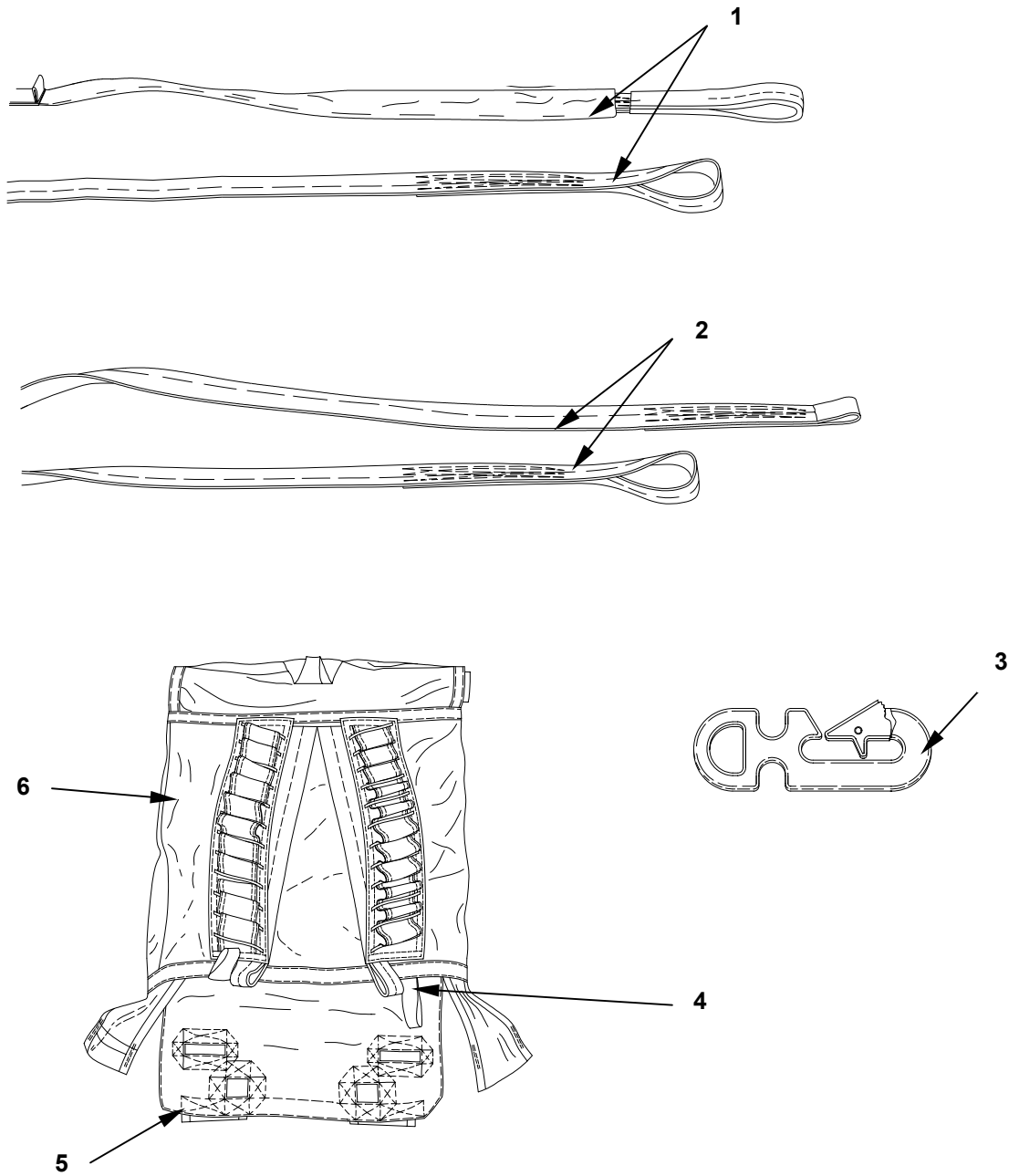

Figure 5. Universal Static Line

**GROUP 04 UNIVERSAL STATIC LINE
REPAIR PARTS LIST**

| (1) ITEM NO. | (2) SMR CODE | (3) CAGEC | (4) PART NO. | (5) DESCRIPTION AND USABLE ON CODES (UOC) | (6) QTY |
|---|-----------------|--------------|-----------------|---|------------|
| Group 04, Universal Static Line Figure 5, Universal Static Line, 11-1-6994-1 | | | | | |
| 1 | PAOZZ | 81337 | 11-1-6993-1 | Line, Static, USL UOC: EPX/FRD | 1 |
| 2 | PAOZZ | 81337 | 11-1-6993-2 | Line, Static, USL Ext UOC: EPX/FRD | 1 |
| 3 | PAOZZ | 81337 | 11-1-6991-1 | Snap Hook, USL UOC: EPX/FRD | 1 |
| 4 | MOOZZ | 81337 | 11-1-2594-18 | Tie-down Loop, Make From Webbing Nylon, P/N PIA- W-4088 Type I 9/16-in. Wide/Thread Nylon, P/N V- T-295 TY I CL A, Size E, Natural, UOC: EPX/FRD | 2 |
| 5 | MOOZZ | 81337 | 11-1-2594-5 | Locking Stow Loop Hood, Make From Cloth Sateen, P/N MIL-C-10296, Class 1 OG Thread, P/N V-T-295 TY I CL A, Size E, Natural, UOC: EPX/FRD | 2 |
| 6 | PAOOO | 81337 | 11-1-6994-1 | Bag, Deployment, USL UOC: EPX/FRD | 1 |
| END OF FIGURE | | | | | |

THIS PAGE INTENTIONALLY LEFT BLANK

THIS PAGE INTENTIONALLY LEFT BLANK

GROUP 05 PERSONNEL PARACHUTE HARNESS

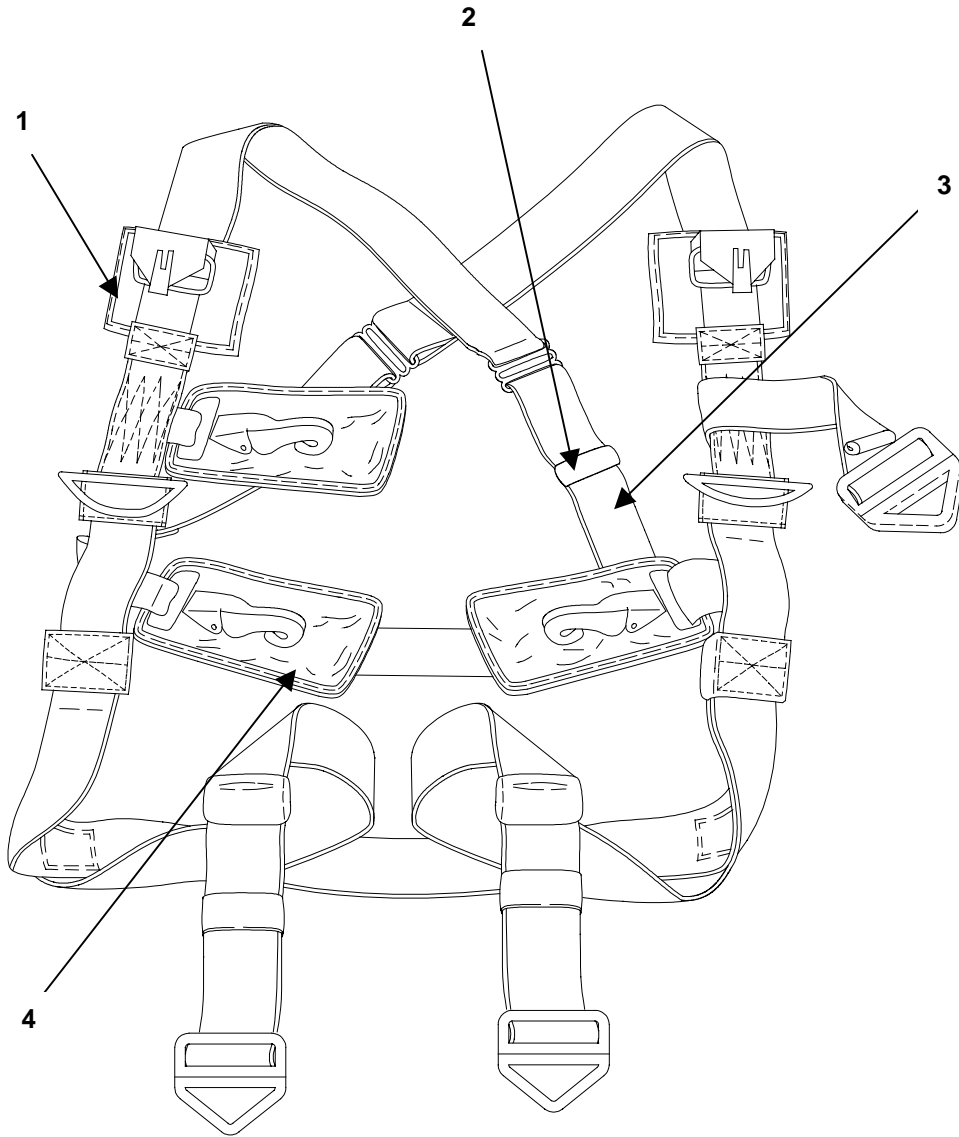

Figure 6. Personnel Parachute Harness

**GROUP 05 PERSONNEL PARACHUTE HARNESS
REPAIR PARTS LIST**

| (1) ITEM NO. | (2) SMR CODE | (3) CAGEC | (4) PART NO. | (5) DESCRIPTION AND USABLE ON CODES (UOC) | (6) QTY |
|--|-----------------|--------------|-----------------|---|------------|
| Group 05, Harness, Personnel Parachute Figure 6, Personnel Parachute Harness, 11-1-2143-1 | | | | | |
| 1 | MOOOO | 98750 | 62C4319 | Canopy Release Pad, Make From Cloth Nylon, Type III, CL 3, OG 106, P/N MIL-C-7219, Rubber Cellular ½-in.-thick, Type II, Grade A CL Soft, P/N MIL-R-5001, Thread Nylon, P/N V-T-295, Type I, CL A OG, Size E, Webbing Nylon, Type I, 9/16-in.-wide, P/N PIA-W-4088, Thread Nylon, P/N V-T-295 Type I, CL A OG, Size 5, UOC: EPX/FRD | 2 |
| 2 | MOOOO | 98750 | 61B4384 | Retainer Webbing, Make From Webbing, Nylon, P/N MIL-W-5664, Type I, OG 1-in.-wide, Thread Nylon, P/N V-T-295, Type I, CL A, OG, Size E, UOC: EPX/FRD | 5 |
| 3 | MOOOO | 81337 | 11-1-2143 | Horizontal Back-strap, Make From Webbing, Nylon P/N PIA-W-4088, Type III, CL R, Thread, Nylon P/N V-T-295 Type I, CL A OG, Size 6, UOC: EPX/FRD | 1 |
| 4 | MOOOO | 81337 | 11-1-2144-26 | Ejector Snap Pad, Make From Cloth Nylon, Type III, CL 3, OG 106, P/N MIL-C-7219, Felt Type I, 3/16-in.-thick, P/N C-F-106, Tape OD Nylon, Type III, 1-in.-wide, P/N PIA-T-5038, Thread Nylon, P/N V-T-295, Type I, CL A OG, Size E, Thread Nylon, P/N V-T-295 Type I, CL A OG, Size 5, UOC: EPX/FRD | 3 |
| END OF FIGURE | | | | | |

THIS PAGE INTENTIONALLY LEFT BLANK

THIS PAGE INTENTIONALLY LEFT BLANK

GROUP 06 PERSONNEL PARACHUTE PACK TRAY

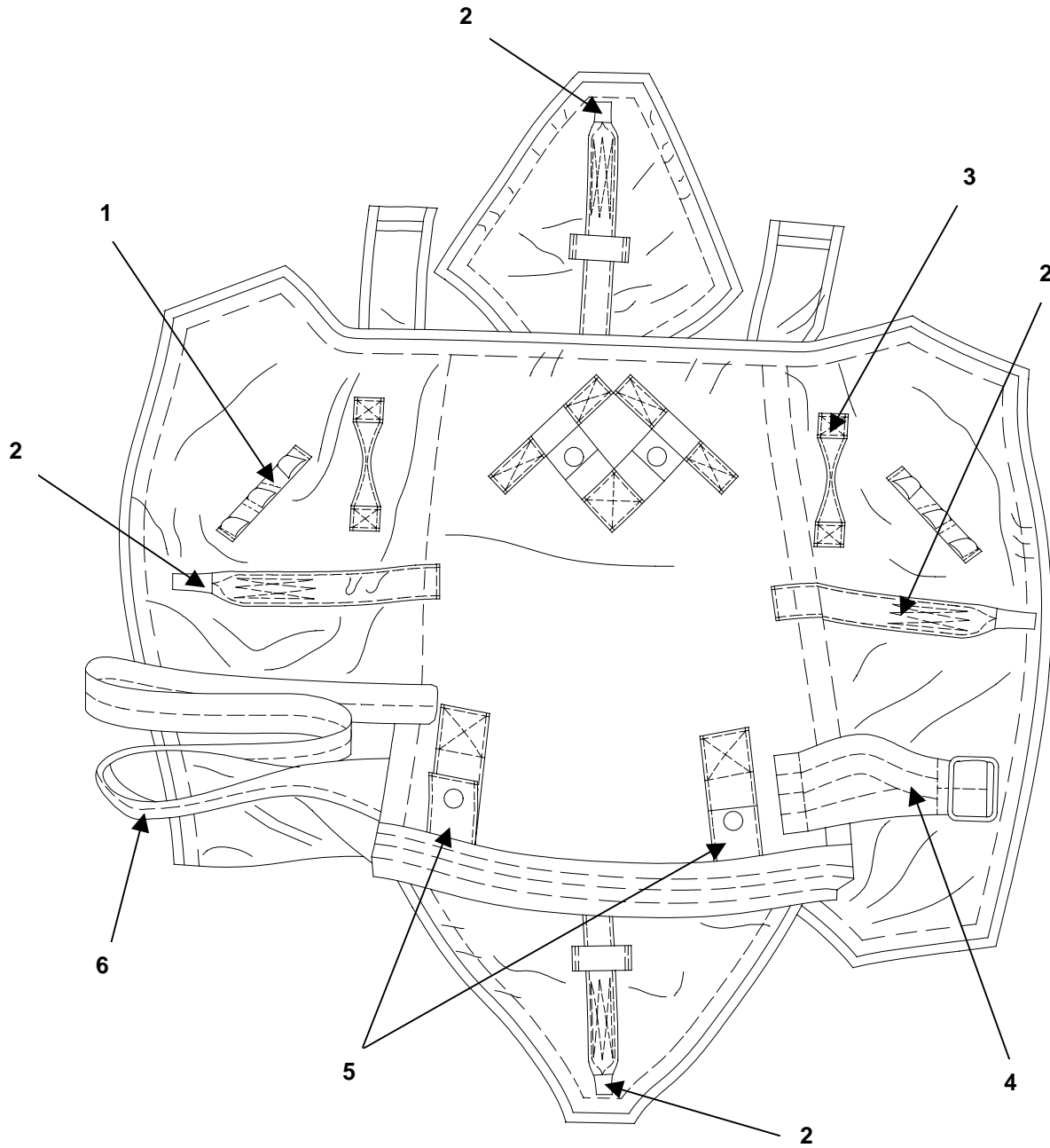

Figure 7. Personnel Parachute Pack Tray

**GROUP 06 PERSONNEL PARACHUTE PACK TRAY
REPAIR PARTS LIST**

| (1) ITEM NO. | (2) SMR CODE | (3) CAGEC | (4) PART NO. | (5) DESCRIPTION AND USABLE ON CODES (UOC) | (6) QTY |
|---|-----------------|--------------|-----------------|---|------------|
| Group 06 Pack Tray, Personnel Parachute Figure 7, Personnel Parachute Pack Tray, 62J4342 | | | | | |
| 1 | MOOOO | 81349 | PIA-T-5038 | Retaining Band, Keeper, Make From Webbing, Nylon P/N PIA-T-5038, TY IV, Class 2, 1-inch Wide, CG 483, UOC: EPX/FRD | |
| 2 | MOOOO | 98750 | 62J4342-15 | Pack Closing Loop, Make From Webbing Nylon, P/N PIA-W-4088, Type III, CL 1 and CL R, MIL-W-27265 OD 7, Thread Nylon V-T- 295, Type I, CL A OD, Size E, UOC: EPX/FRD | 4 |
| 3 | MOOOO | 98750 | 62J4342-4 | Retaining Band, Keeper Long, Make From Webbing Nylon, P/N PIA-W-4088, TY XVII, CL I, OD 7, Thread Nylon, P/N V-T-295, Type I, CL A OD, Size E, UOC: EPX/FRD | |
| 4 | XDOOO | 98750 | 62J4342-24 | Waistband Adjuster Panel, UOC: EPX/FRD | 1 |
| 5 | MOOOO | 98750 | 62J4342-4 | Back Strap Keeper, Make From Webbing Nylon, P/N PIA-W-4088, Type XVII, CL 1 and CL R, MIL-W-27265, OD 7, Thread Nylon V-T- 295, Type I, CL A OD, Size E, UOC: EPX/FRD | 2 |
| 6 | XDOOO | 98750 | 62J4342-20 | Waistband, UOC: EPX/FRD | 1 |
| END OF FIGURE | | | | | |

THIS PAGE INTENTIONALLY LEFT BLANK

GROUP 99 BULK MATERIALS

| (1) ITEM NO. | (2) SMR CODE | (3) CAGEC | (4) PART NO. | (5) DESCRIPTION AND USABLE ON CODES (UOC) | (6) QTY |
|--------------------------|-----------------|--------------|-----------------|--|------------|
| Group 99, Bulk Materials | | | | | |
| 1 | PBOZZ | 96906 | MS27983-1 | Cap, Snap Fastener | EA |
| 2 | PAOZZ | 81349 | MIL-C-43805 | Cloth, Netting, Nylon, 3¾-in. Sq. Mesh, 18-in.-wide | YD |
| 3 | PCOZZ | 81349 | MIL-C-7219 | Cloth, Nylon, Type III, CL 3, OG 106 | YD |
| 4 | PAOZZ | 81349 | PIA-C-44378 | Cloth, Parachute, Nylon, Low Permeability, 36-in.- wide, Green | YD |
| 5 | PAOZZ | 81349 | PIA-C-44378 | Cloth, Parachute, Nylon, Low Permeability, 48-in.- wide, Green | YD |
| 6 | PAOZZ | 81349 | MIL-C-10296 | Cloth, Sateen, CL 1, OG, 56-in.-wide | YD |
| 7 | PAOZZ | 81349 | PIA-C-5040 | Cord, Nylon, Type II, OG | YD |
| 8 | PAOZZ | 58536 | A-A-1975 | Dowel, Wood, Hardwood, 5/8-in. Diameter | EA |
| 9 | PAOZZ | 81348 | C-F-206 | Felt Sheet, Type I, 3/16-in.- thick | SH |
| 10 | PAOZZ | 96906 | MS27983-4 | Post, Snap Fastener | HD |
| 11 | PCOZZ | 81349 | MIL-R-5001 | Rubber, Sheet, Cellular Type II, Grade A | SA |
| 12 | PBOZZ | 96906 | MS27983-2 | Socket, Snap Fastener | EA |
| 13 | PBOZZ | 96906 | MS27983-3 | Stud, Snap Fastener | HD |
| 14 | PAOZZ | 81349 | PIA-T-1001 | Tape, Nylon Tubular, Type I, 1-in.-wide, OD | YD |
| 15 | PAOZZ | 81349 | PIA-T-1001 | Tape, Nylon, Tubular, Type I, 1-in.-wide, Natural | YD |
| 16 | PAOZZ | 81349 | PIA-W-4088 | Tape, Nylon, Type I, 9/16-in.- wide, OD | YD |
| 17 | PAOZZ | 81349 | PIA-T-5038 | Tape, Nylon, Type III, ¾-in.- wide, OD | YD |
| 18 | PAOZZ | 81349 | PIA-T-5038 | Tape, Nylon, Type III, 1½- in.-wide, OD | YD |

GROUP 99 BULK MATERIALS

| (1) ITEM NO. | (2) SMR CODE | (3) CAGEC | (4) PART NO. | (5) DESCRIPTION AND USABLE ON CODES (UOC) | (6) QTY |
|--------------------------|-----------------|--------------|-----------------|---|------------|
| Group 99, Bulk Materials | | | | | |
| 19 | PAOZZ | 81349 | PIA-T-5038 | Tape, Nylon, Type III, 1-in.-wide, OD | YD |
| 20 | PAOZZ | 81349 | PIA-W-4088 | Tape, Nylon, Type III, CL R, 1¼-in.-wide, OD | YD |
| 21 | PAOZZ | 81349 | PIA-T-5038 | Tape, Nylon, Type IV, 1-in.-wide, OD | YD |
| 22 | PAOZZ | 81348 | V-T-276 | Thread, Cotton, Type I B3, Size 24/4, White | SL |
| 23 | PAOZZ | 81348 | V-T-295 | Thread, Nylon, Type I, CL A, Size 3, Natural | SL |
| 24 | PAOZZ | 81348 | V-T-295 | Thread, Nylon, Type I, CL A, Size 3, OD | SL |
| 25 | PAOZZ | 81348 | V-T-295 | Thread, Nylon, Type I, CL A, Size 6, Natural | SL |
| 26 | PAOZZ | 81348 | V-T-295 | Thread, Nylon, Type I, CL A, Size A, Natural | SL |
| 27 | PAOZZ | 81348 | V-T-295 | Thread, Nylon, Type I, CL A, Size E, Natural | SL |
| 28 | PAOZZ | 81348 | V-T-295 | Thread, Nylon, Type I, CL A, Size E, OD | SL |
| 29 | PAOZZ | 81349 | MIL-W-5661 | Webbing, Cotton, Type I, 1-in.-wide, Natural | YD |
| 30 | PCOZZ | 81349 | MIL-W-5664 | Webbing, Elastic, Cotton, CL 1, 1-in.-wide, OG | YD |
| 31 | PAOZZ | 81349 | PIA-W-5625 | Webbing, Nylon, Tubular, 1-in.-wide, OG | YD |
| 32 | PAOZZ | 81349 | MIL-W-5038 | Webbing, Nylon, Type IV, 1-in.-wide, OG | YD |
| 33 | PAOZZ | 81349 | PIA-W-4088 | Webbing, Nylon, Type VII, 9/16-in.-wide, OG | YD |
| 34 | PAOZZ | 81349 | PIA-W-4088 | Webbing, Nylon, Type VIII, 1 ²³ / ₃₂ -in.-wide, OD | YD |
| 35 | PAOZZ | 81349 | PIA-W-4088 | Webbing, Nylon, Type XIII, CL R, 2 ³ / ₃₂ -in.-wide, OD | YD |
| 36 | PAOZZ | 81349 | PIA-W-4088 | Webbing, Nylon, Type XVII, CL R, 1-in.-wide, OD | YD |
| 37 | PBOZZ | 81348 | QQ-W-423 | Wire, Steel, Form I, Composition 430, Condition A | LB |
| END OF FIGURE | | | | | |

**MC1-1C/MC1-1D TROOP BACK PARACHUTE ASSEMBLY
SPECIAL TOOLS LIST**

Not Applicable

END OF WORK PACKAGE

THIS PAGE INTENTIONALLY LEFT BLANK

MC1-1C/MC1-1D TROOP BACK PARACHUTE ASSEMBLY
NATIONAL STOCK NUMBER INDEX

| NATIONAL STOCK NUMBER INDEX | | |
|-----------------------------|--------|------|
| STOCK NUMBER | FIGURE | ITEM |
| 1670-00-086-7780 | 1 | 7 |
| 8315-00-176-8083 | BULK | 17 |
| 1670-00-217-2421 | 2 | 21 |
| 9320-00-232-2473 | BULK | 11 |
| 8315-00-238-8089 | BULK | 14 |
| 5510-00-240-0070 | BULK | 8 |
| 5510-00-240-0070 | 2 | 1 |
| 8310-00-248-9714 | BULK | 23 |
| 8310-00-248-9716 | BULK | 25 |
| 8315-00-255-7675 | BULK | 15 |
| 8305-00-260-4586 | BULK | 35 |
| 8305-00-260-6909 | BULK | 16 |
| 8305-00-261-8579 | BULK | 32 |
| 8305-00-261-8579 | BULK | 18 |
| 8305-00-261-8579 | 7 | 1 |
| 8310-00-261-9741 | BULK | 22 |
| 4020-00-262-2019 | BULK | 7 |
| 8310-00-262-2770 | BULK | 27 |
| 8310-00-262-2772 | BULK | 28 |
| 8310-00-262-3324 | BULK | 26 |
| 8305-00-263-3598 | BULK | 34 |
| 8315-00-263-3604 | BULK | 20 |
| 8305-00-267-3009 | BULK | 36 |
| 8310-00-267-3027 | BULK | 24 |
| 8305-00-268-2411 | BULK | 29 |
| 8305-00-268-2455 | BULK | 31 |
| 5305-00-269-6657 | 2 | 22 |
| 8305-00-270-1894 | BULK | 30 |
| 5325-00-276-4908 | BULK | 13 |
| 5325-00-276-4978 | BULK | 12 |
| 8305-00-281-3013 | BULK | 33 |
| 8305-00-290-5584 | BULK | 9 |

| NATIONAL STOCK NUMBER INDEX | | |
|-----------------------------|--------|------|
| STOCK NUMBER | FIGURE | ITEM |
| 1670-00360-0469 | 2 | 3 |
| 1670-00-360-0469 | 3 | 3 |
| 5340-00-491-1065 | 4 | 4 |
| 1670-00-590-9909 | 1 | 1 |
| 8315-00-753-5952 | BULK | 21 |
| 8305-00-765-2863 | BULK | 3 |
| 5325-00-891-9073 | BULK | 1 |
| 9505-00-892-4616 | BULK | 37 |
| 9505-00-892-4616 | 4 | 3 |
| 5325-00-893-6243 | BULK | 10 |
| 1670-00-925-7843 | 4 | 1 |
| 8315-00-935-4741 | BULK | 19 |
| 8305-00-943-0981 | BULK | 6 |
| 1670-01-007-8563 | 1 | 9 |
| 8305-01-010-7033 | BULK | 2 |
| 8305-01-010-7033 | 2 | 23 |
| 1670-01-262-2360 | 1 | 6 |
| 1670-01-272-1901 | 1 | 8 |
| 8305-01-315-7955 | BULK | 4 |
| 8305-01-315-7956 | BULK | 5 |
| 1670-01-476-3068 | 1 | 3 |
| 1670-01-476-3068 | 5 | 1 |
| 1670-01-476-3130 | 5 | 2 |
| 1670-01-476-3130 | 1 | 4 |
| 1670-01-476-3131 | 5 | 6 |
| 1670-01-476-3131 | 1 | 2 |
| 1670-01-476-3142 | 5 | 3 |
| 1670-01-476-3142 | 1 | 5 |
| END OF INDEX | | |

END OF WORK PACKAGE

THIS PAGE INTENTIONALLY LEFT BLANK

**MC1-1C/MC1-1D TROOP BACK PARACHUTE ASSEMBLY
PART NUMBER INDEX**

| PART NUMBER INDEX | | | | |
|-------------------|--------------|------------------|--------|------|
| CAGE CODE | PART NUMBER | STOCK NUMBER | FIGURE | ITEM |
| 81337 | 11-1-1501-3 | 1670-01-262-2360 | 1 | 6 |
| 81337 | 11-1-2143 | | 6 | 3 |
| 81337 | 11-1-2143-1 | 1670-01-272-1901 | 1 | 8 |
| 81337 | 11-1-2144-26 | | 6 | 4 |
| 81337 | 11-1-2149 | | 3 | 1 |
| 81337 | 11-1-2149 | | 3 | 2 |
| 81337 | 11-1-2149 | | 3 | 4 |
| 81337 | 11-1-2149-1 | 1670-01-007-8563 | 1 | 9 |
| 81337 | 11-1-2594-18 | | 4 | 5 |
| 81337 | 11-1-2594-18 | | 5 | 4 |
| 81337 | 11-1-2594-5 | | 4 | 6 |
| 81337 | 11-1-2674-1 | | 2 | 11 |
| 81337 | 11-1-2674-2 | | 2 | 12 |
| 81337 | 11-1-2674-3 | | 2 | 13 |
| 81337 | 11-1-2674-4 | | 2 | 14 |
| 81337 | 11-1-6991-1 | 1670-01-476-3142 | 1 | 5 |
| 81337 | 11-1-6991-1 | 1670-01-476-3142 | 5 | 3 |
| 81337 | 11-1-6993-1 | 1670-01-476-3068 | 1 | 3 |
| 81337 | 11-1-6993-1 | 1670-01-476-3068 | 5 | 1 |
| 81337 | 11-1-6993-2 | 1670-01-476-3130 | 1 | 4 |
| 81337 | 11-1-6993-2 | 1670-01-476-3130 | 5 | 2 |
| 81337 | 11-1-6994-1 | 1670-01-476-3131 | 1 | 2 |
| 81337 | 11-1-6994-1 | 1670-01-476-3131 | 5 | 6 |
| 81337 | 11-1-2594-5 | | 5 | 5 |
| 98750 | 55B6261 | 9505-00-892-4616 | 4 | 3 |
| 98750 | 55D6481-20 | 1670-00-925-7843 | 4 | 1 |
| 98750 | 55D6481-5 | | 4 | 2 |
| 98750 | 56D6276 | 1670-00-590-9909 | 1 | 1 |
| 98750 | 58H6361-1 | | 2 | 15 |
| 98750 | 58H6361-2 | | 2 | 16 |
| 98750 | 58H6361-3 | | 2 | 17 |
| 98750 | 58H6361-4 | | 2 | 18 |
| 98750 | 58H6361-5 | | 2 | 19 |
| 98750 | 61B4384 | | 6 | 2 |
| 98750 | 62C4319 | | 6 | 1 |
| 81337 | 62J4342 | 1670-00-086-7780 | 1 | 7 |
| 98750 | 62J4342-15 | | 7 | 2 |
| 98750 | 62J4342-20 | | 7 | 6 |
| 98750 | 62J4342-24 | | 7 | 4 |
| 98750 | 62J4342-4 | | 7 | 3 |
| 98750 | 62J4342-4 | | 7 | 5 |
| 58536 | A-A-1975 | 5510-00-240-0070 | 2 | 1 |
| 98750 | 68K147 | | 2 | 10 |
| 98750 | 68K147 | | 2 | 20 |
| 98750 | 68K147-15 | | 2 | 6 |
| 98750 | 68K147-17 | | 2 | 5 |
| 98750 | 68K147-18 | | 2 | 9 |
| 98750 | 68K147-19 | | 2 | 8 |
| 98750 | 68K147-20 | | 2 | 4 |
| 98750 | 68K147-21 | | 2 | 2 |
| 98750 | 68K147-22 | | 2 | 7 |
| 58536 | A-A-1975 | 5510-00-240-0070 | BULK | 8 |

**MC1-1C/MC1-1D TROOP BACK PARACHUTE ASSEMBLY
PART NUMBER INDEX**

| PART NUMBER INDEX - continued | | | | |
|--------------------------------------|--------------------|---------------------|---------------|-------------|
| CAGE CODE | PART NUMBER | STOCK NUMBER | FIGURE | ITEM |
| 81348 | C-F-206 | 8305-00-290-5584 | BULK | 9 |
| 81349 | MIL-C-10296 | 8305-00-943-0981 | BULK | 6 |
| 81349 | MIL-C-43805 | 8305-01-010-7033 | BULK | 2 |
| 81349 | MIL-C-43805 | 8305-01-010-7033 | 2 | 23 |
| 81349 | MIL-C-7219 | 8305-00-765-2863 | BULK | 3 |
| 81349 | MIL-R-5001 | 9320-00-232-2473 | BULK | 11 |
| 81349 | MIL-T-5038 | 8305-00-261-8579 | BULK | 32 |
| 81349 | MIL-W-5625 | 8305-00-268-2455 | BULK | 31 |
| 81349 | MIL-W-5661 | 8305-00-268-2411 | BULK | 29 |
| 81349 | MIL-W-5664 | 8305-00-270-1894 | BULK | 30 |
| 96906 | MS27983-1 | 5325-00-891-9073 | BULK | 1 |
| 96906 | MS27983-2 | 5325-00-276-4978 | BULK | 12 |
| 96906 | MS27983-3 | 5325-00-276-4908 | BULK | 13 |
| 96906 | MS27983-4 | 5325-00-893-6243 | BULK | 10 |
| 81349 | PIA-C-44378 | 8305-01-315-7955 | BULK | 4 |
| 81349 | PIA-C-44378 | 8305-01-315-7956 | BULK | 5 |
| 81349 | PIA-C-5040 | 4020-00-262-2019 | BULK | 7 |
| 81349 | PIA-T-1001 | 8315-00-255-7675 | BULK | 15 |
| 81349 | PIA-T-1001 | 8315-01-238-8089 | BULK | 14 |
| 81349 | PIA-T-5038 | 8315-00-176-8083 | BULK | 17 |
| 81349 | PIA-T-5038 | 8315-00-935-4741 | BULK | 19 |
| 81349 | PIA-T-5038 | 8315-00-753-5952 | BULK | 21 |
| 81349 | PIA-T-5038 | 8305-00-261-8579 | 7 | 1 |
| 81349 | PIA-W-4088 | 8305-00-260-6909 | BULK | 16 |
| 81349 | PIA-W-4088 | 8315-00-263-3604 | BULK | 20 |
| 81349 | PIA-W-4088 | 8305-00-263-3598 | BULK | 34 |
| 81349 | PIA-W-4088 | 8305-00-260-4586 | BULK | 35 |
| 81349 | PIA-W-4088 | 8305-00-267-3009 | BULK | 36 |
| 81349 | PIA-W-4088 | 8305-00-281-3013 | BULK | 33 |
| 81349 | PIA-W-5038 | 8305-00-261-8579 | BULK | 18 |
| 96906 | PS22002-1 | 1670-00-217-2421 | 2 | 21 |
| 96906 | PS22002-7 | 5305-00-269-6657 | 2 | 22 |
| 96906 | PS27762-1 | 1670-00-360-0469 | 3 | 3 |
| 96906 | PS27762-1 | 1670-00-360-0469 | 2 | 3 |
| 96906 | PS70120 | 5340-00-491-1065 | 4 | 4 |
| 81348 | QQ-W-423 | 9505-00-892-4616 | BULK | 37 |
| 81348 | V-T-276 | 8310-00-261-9741 | BULK | 22 |
| 81348 | V-T-295 | 8310-00-248-9714 | BULK | 23 |
| 81348 | V-T-295 | 8310-00-267-3027 | BULK | 24 |
| 81348 | V-T-295 | 8310-00-248-9716 | BULK | 25 |
| 81348 | V-T-295 | 8310-00-262-3324 | BULK | 26 |
| 81348 | V-T-295 | 8310-00-262-2770 | BULK | 27 |
| 81348 | V-T-295 | 8310-00-262-2772 | BULK | 28 |
| END OF INDEX | | | | |

END OF WORK PACKAGE

**MC1-1C/MC1-1D TROOP BACK PARACHUTE ASSEMBLY
EXPENDABLE/DURABLE SUPPLIES AND MATERIALS LIST**

SCOPE

This appendix lists expendable supplies and materials you will need to operate and maintain the 35-Foot Diameter Parachute. These items are authorized to you by CTA 50-970, Expendable Items (Except Medical, Class V, Repair Parts, and Heraldic Items).

EXPLANATION OF COLUMNS

Column 1, Item Number. This number is assigned to the entry in the listing and is referenced in the narrative instructions to identify the material (e.g., Use Cloth, Abrasive (Item 6, WP 0055 00)).

Column 2, Level. This column identifies the lowest level of maintenance that requires the listed item. (Enter as applicable).

- C - Operator or Crew
- O - Unit Maintenance
- F - Direct Support Maintenance
- H - General Support Maintenance
- D - Depot Maintenance

Column 3, National Stock Number (NSN). This is the National stock number assigned to the item; use it to request or requisition the item.

Column 4, Description. Indicates the Federal item name and, if required, a description to identify the item.

Column 5, Unit of Measure (U/M). Indicates the measure used in performing the actual maintenance function. This measure is expressed by a two-character alphabetical abbreviation (e.g., ea., in., pr.). If the unit of measure differs from the unit of issue, requisition the lowest unit of issue that will satisfy your requirements.

Table 1. Expendable/Durable Supplies and Materials List

| (1) ITEM NUMBER | (2) LEVEL | (3) NATIONAL STOCK NUMBER | (4) DESCRIPTION | (5) UNIT OF MEASURE |
|-----------------------|--------------|---------------------------------|--|---------------------------|
| 1 | O | 1670-00-568-0323 | Band, Rubber Retainer | BX |
| 2 | O | 9160-00-253-1171 | Beeswax, Technical, 1-lb. Cake | EA |
| 3 | O | 7920-00-282-2470 | Brush, Scrub, Household | EA |
| 4 | O | 7520-00-248-9285 | Brush, Stenciling | EA |
| 5 | O | 5325-00-891-9073 | Cap, Snap Fastener | EA |
| 6 | O | 5350-00-221-0872 | Cloth, Abrasive | YD |
| 7 | O | 8305-00-943-0981 | Cloth, Cotton Sateen, 8.2-oz. | YD |
| 8 | O | 8305-00-765-2863 | Cloth, Duck, Nylon, Type III | YD |
| 9 | O | 8305-00-433-5986 | Cloth, Muslin-Cotton, Type III | YD |
| 10 | O | 8305-01-010-7033 | Cloth, Netting, Nylon, 3¾-in. Square Mesh, 18-in.-wide | YD |
| 11 | O | 1670-00-176-1802 | Cloth, Parachute Mending | YD |
| 12 | O | 8305-01-315-7955 | Cloth, Parachute, Low Permeability, Type I, 36-in.-wide, Green | YD |
| 13 | O | 8305-01-315-7956 | Cloth, Parachute, Low Permeability, Type I, 48-in.-wide, Green | YD |

**MC1-1C/MC1-1D TROOP BACK PARACHUTE ASSEMBLY
EXPENDABLE/DURABLE SUPPLIES AND MATERIALS LIST**
Table 1. Expendable/Durable Supplies and Materials List -- Continued

| (1) ITEM NUMBER | (2) LEVEL | (3) NATIONAL STOCK NUMBER | (4) DESCRIPTION | (5) UNIT OF MEASURE |
|-----------------------|--------------|---------------------------------|--|---------------------------|
| 14 | O | 4020-00-262-2019 | Cord, Nylon, Type II | YD |
| 15 | O | 4020-00-246-0688 | Cord, Nylon, Type III | YD |
| 16 | O | 7930-00-281-4731 | Dishwashing Compound, Hand Flake | 50-lb. Sack |
| 17 | O | 5510-00-240-0070 | Dowel, Hardwood, $\frac{5}{8}$ -Inch Diameter | EA |
| 18 | O | 8315-00-106-5973 | Fastener Tape, Hook | YD |
| 19 | O | 8315-00-106-5974 | Fastener Tape, Pile | YD |
| 20 | O | 8305-00-290-5584 | Felt, Type I, $\frac{3}{16}$ -in.-thick | SF |
| 21 | O | 7510-00-634-6583 | Ink, Marking, Parachute, Orange-Yellow | BT |
| 22 | O | 7510-00-286-5362 | Ink, Marking, Parachute, Strata-Blue | BT |
| 23 | O | 1670-00-925-5615 | Kit, Canopy Release | KT |
| 24 | O | 9150-00-754-0064 | Lubricant, Solid Film | CN |
| 25 | O | 7520-000-973-1059 | Marker, Felt Tip, Black | BX |
| 26 | O | 8010-01-122-1969 | Paint, Enamel, Yellow, 33538 | QT |
| 27 | O | 8315-00-160-7759 | Paper, Kraft, Untreated | RL |
| 28 | O | 7520-01-060-5820 | Pen, Ballpoint | DZ |
| 29 | O | 7510-00-240-1525 | Pencil, China-Marking, White | BX |
| 30 | O | 5325-00-276-4978 | Post, Fastener | BX |
| 31 | O | 7390-00-205-3570 | Rag, Wiping | BL |
| 32 | O | 1670-00-360-0469 | Reefing Ring, Control Line | EA |
| 33 | O | 9320-00-232-2473 | Rubber, Cellular, $\frac{1}{2}$ -in. thick | SH |
| 34 | O | 5325-00-893-6243 | Socket, Fastener | EA |
| 35 | O | 9310-00-160-7858 | Stencil Board, Oiled | SH |
| 36 | O | 5325-00-276-4908 | Stud, Fastener | EA |
| 37 | O | 7510-00-550-7124 | Tape, Adhesive, Pressure Sensitive, $\frac{1}{2}$ -in., Blue | RO |
| 38 | O | 4020-00-753-6555 | Tape, Lacing and Tying | YD |
| 39 | O | 7510-00-266-6712 | Tape, Masking, 1-Inch Wide | RO |
| 40 | O | 7510-00-266-6710 | Tape, Masking, 2-Inch Wide | RO |
| 41 | O | 8315-00-238-8089 | Tape, Nylon, OD 7, 1-in.-wide | YD |
| 42 | O | 8315-00-255-7675 | Tape, Nylon, Tubular, Natural, 1-in.-wide | YD |
| 43 | O | 8315-00-753-5952 | Tape, Nylon, Type III, $1\frac{1}{2}$ -in.-wide | RL |
| 44 | O | 8315-00-176-8083 | Tape, Nylon, Type III, $\frac{3}{4}$ -in.-wide | RL |

**MC1-1C/MC1-1D TROOP BACK PARACHUTE ASSEMBLY
EXPENDABLE/DURABLE SUPPLIES AND MATERIALS LIST**
Table 1. Expendable/Durable Supplies and Materials List -- Continued

| (1) ITEM NUMBER | (2) LEVEL | (3) NATIONAL STOCK NUMBER | (4) DESCRIPTION | (5) UNIT OF MEASURE |
|-----------------------|--------------|---------------------------------|---|---------------------------|
| 45 | O | 8315-00-263-3604 | Tape, Nylon, Type III, 1¼-in.-wide, OD, CLR | RL |
| 46 | O | 8315-00-935-4741 | Tape, Nylon, Type III, 1-in.-wide, OD | YD |
| 47 | O | 7510-00-663-0196 | Tape, Pressure Sensitive, 2-in., OD (81348) PP-T-60 | RO |
| 48 | O | 8310-00-261-9741 | Thread, Cotton, Ticket 24/4, Natural | TU |
| 49 | O | 8310-00-262-2772 | Thread, Nylon, Green, Size E | TU |
| 50 | O | 8310-00-248-9714 | Thread, Nylon, Natural, Size 3 | TU |
| 51 | O | 8310-00-262-3324 | Thread, Nylon, Natural, Size A | TU |
| 52 | O | 8310-00-262-2770 | Thread, Nylon, Natural, Size E | TU |
| 53 | O | 8310-00-267-3027 | Thread, Nylon, OD, Size 3 | TU |
| 54 | O | 8310-00-262-2780 | Thread, Nylon, Size 6, OG | TU |
| 55 | O | 9160-00-285-2044 | Wax, Paraffin, 1-lb. Cake | EA |
| 56 | O | 8305-00-270-1894 | Webbing, Elastic, Cotton, 1-in.-wide | YD |
| 57 | O | 8305-00-268-2411 | Webbing, Textile, Cotton, Type I, ¼- in.-wide | YD |
| 58 | O | 8305-00-260-2561 | Webbing, Textile, Cotton, Type II | YD |
| 59 | O | 8305-00-935-3252 | Webbing, Textile, Cotton, Type VI | YD |
| 60 | O | 8305-00-268-2453 | Webbing, Textile, Nylon, Tubular, ½- in.-wide | YD |
| 61 | O | 8305-00-268-2455 | Webbing, Textile, Nylon, Tubular, 1- in.-wide | YD |
| 62 | O | 8305-00-260-6909 | Webbing, Textile, Nylon, Type I, ⁹ / ₁₆ - in.-wide | YD |
| 63 | O | 8305-00-176-8083 | Webbing, Textile, Nylon, Type III, ³ / ₄ - Inch Wide, OD | YD |
| 64 | O | 8305-00-281-3013 | Webbing, Textile, Nylon, Type VI | YD |
| 65 | O | 8305-00-263-3598 | Webbing, Textile, Nylon, Type VIII | YD |
| 66 | O | 8305-00-811-1615 | Webbing, Textile, Nylon, Type VIII, Blue | YD |
| 67 | O | 8035-00-260-4586 | Webbing, Textile, Nylon, Type XIII | YD |
| 68 | O | 8305-00-267-3009 | Webbing, Textile, Nylon, Type XVII | YD |
| 69 | O | 9505-00-892-4616 | Wire, Steel, 0.080-in. Diameter | CL |
| 70 | O | 8305-00-261-8579 | Webbing, Nylon, Type IV, 1-inch wide, OG | YD |
| 71 | O | 8010-00-297-0809 | Paint, Enamel, Red | QT |
| 72 | O | 8310-00-248-9716 | Thread, Nylon, Natural, Size 6 | TU |

END OF WORK PACKAGE

THIS PAGE INTENTIONALLY LEFT BLANK

**MC1-1C/MC1-1D TROOP BACK PARACHUTE ASSEMBLY
ILLUSTRATED LIST OF MANUFACTURED ITEMS
ANTI-INVERSION NET PRESSER FOOT**

Modify the sewing presser foot in accordance with the illustrations below. Use the modified presser foot to aid in the repair of the anti-inversion net.

NOTE

Data in this figure may be used to modify the presser foot for repair of the anti-inversion net. A modified presser foot for splicing only net cords does not require the $\frac{1}{16}$ -inch groove illustrated in View A.

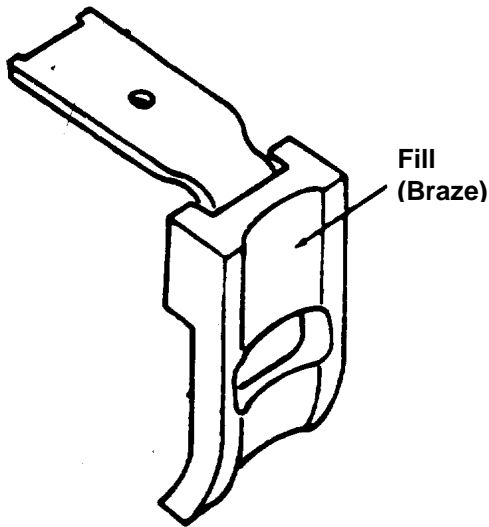

**Standard Zig-Zag
Presser Foot**

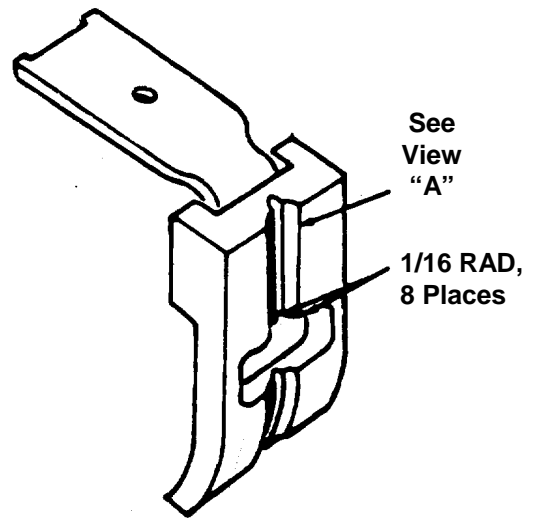

**Modified Presser Foot For
Anti-Inversion Net Repairs**

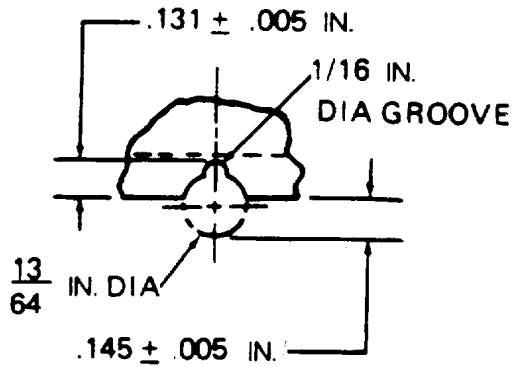

View "A"

THIS PAGE INTENTIONALLY LEFT BLANK

ALPHABETICAL INDEX

Subject

WP Sequence No. – Page No.

A

| | |
|--|------------|
| Accomplishing a Log Record | 0003 00-5 |
| Accordion Folding/Rigger Rolling | 0040 00-2 |
| Acronyms and Abbreviations..... | 0001 00-3 |
| After-Use Receipt | 0003 00-9 |
| Air Force Technical Order Forms | 0041 00-2 |
| Air Force Technical Orders | 0041 00-2 |
| Airing (and Shakeout) (Unit)..... | 0007 00-1 |
| Anti-Inversion Net Presser Foot | 0056 00-1 |
| Anti-Inversion Net, Inspect (Unit) | 0023 00-1 |
| Anti-Inversion Net, Repair (Unit) | 0023 00-1 |
| Anti-Inversion Net, Replace (Unit)..... | 0023 00-5 |
| Army Parachute Log Record | 0011 00-52 |
| Army Regulations | 0041 00-2 |
| Assembling the MC1-1C/MC1-1D Parachute | 0004 00-1 |
| Attaching Universal Static Line..... | 0011 00-55 |

B

| | |
|-----------------------------------|-----------|
| Basting (DS) | 0032 00-1 |
| Basting (Unit)..... | 0012 00-2 |
| Bridle Loop, Repair (Unit)..... | 0015 00-1 |
| Bridle Loop, Replace (Unit) | 0015 00-1 |
| Bulk Materials List | 0051 00-2 |

C

| | |
|--|------------|
| Cleaning and Drying (Unit) | 0008 00-1 |
| Cleaning Fabric Items With Hand Dishwashing Compound | 0008 00-2 |
| Cleaning Metal Items..... | 0008 00-3 |
| Closing Deployment Bag | 0011 00-34 |
| Closing Pack Tray | 0011 00-42 |
| Common Name | 0001 00-3 |
| Common Tools and Equipment..... | 0001 00-5 |
| Configuration/Condition | 0003 00-2 |
| Connector Link Assembly, Repair (Unit) | 0027 00-1 |
| Connector Link Assembly, Replace (Unit)..... | 0027 00-1 |
| Control Line Bridle, Repair (Unit) | 0025 00-1 |
| Control Line Bridle, Replace (Unit)..... | 0025 00-1 |
| Control Line, Repair (Unit)..... | 0026 00-1 |
| Control Line, Replace (Unit) | 0026 00-1 |
| Corrosion Prevention And Control (CPC)..... | 0001 00-2 |

Subject **WP Sequence No. – Page No.**

D

Darning (Unit)0012 00-4
 Deployment Bag, Repair (Unit)0029 00-1
 Deployment Bag, Replace (Unit).....0029 00-13
 Description Of Major Components0002 00-1
 Destruction Of Army Materiel To Prevent Enemy Use.....0001 00-2
 Drop Testing Criteria0005 00-1
 Drying Fabric Items 0008 00-3/0010 00-2

E

Equipment Characteristics, Capabilities And Features0002 00-1
 Equipment Data0002 00-6
 Equipment Description and Data.....0002 00-1
 Equipment Disposition.....0009 00-3
 Equipment Improvements and Recommendations, Reporting (EIR)0001 00-2
 Equipment Name0001 00-1
 Expendable/Durable Supplies and Materials List.....0055 00-1
 Explanation of Columns in Remarks, Table 30042 00-3
 Explanation of Columns in the MAC, Table 10042 00-2
 Explanation of Columns in the RPSTL0046 00-1
 Explanation of Columns in the Tools and Test Equipment Requirements, Table 2.....0042 00-3

F

Field Manuals0041 00-2
 Folding Canopy Gores.....0011 00-15
 Folding Harness0011 00-57
 Forms0041 00-2
 Fresh-Water Contamination Test0010 00-1

G

General Information.....0001 00-1
 General Procedures for Air Delivery Equipment0003 00-1
 General Storage Requirements.....0039 00-1
 Gore Sections, Repair (Unit)0018 00-1
 Gore Sections, Replace (DS)0036 00-1

H

Harness Assembly, Repair (Unit)0030 00-1
 Harness Assembly, Replace (Unit)0030 00-1
 How to Locate Repair Parts0046 00-7
 How to Use this Manual v

Subject

WP Sequence No. – Page No.

I

| | |
|--|----------------------|
| Illustrated List of Manufactured Items | 0056 00-1 |
| Initial Receipt | 0003 00-1 |
| In-Storage Inspection | 0009 00-3/ 0040 00-1 |
| Introduction To Maintenance Allocation Chart (MAC) | 0042 00-1 |
| Inspection | 0009 00-1 |
| Inspection Personnel | 0003 00-1 |
| Installing Attaching Tie | 0003 00-3 |

L

| | |
|--|------------|
| List of Acronyms and Abbreviations | 0001 00-3 |
| List of Effective Pages | A |
| Location And Description of Major Components | 0002 00-1 |
| Locking Stow Loop Hood, Repair | 0029 00-6 |
| Long-Folding the Canopy | 0011 00-26 |
| Lower Lateral Band, Repair (Unit) | 00020 00-1 |
| Lubrication Service Intervals | 0006 00-6 |

M

| | |
|--|-------------------------|
| Maintenance Allocation Chart (MAC), Introduction | 0042 00-1 |
| Maintenance Allocation Chart (MAC), Table 1 | 0042 00-4 |
| Maintenance Forms, Records and Reports | 0001 00-1 |
| Maintenance Functions | 0042 00-1 |
| Maintenance Functions/Procedures | 0005 00-1 |
| Maintenance Procedures, Unit | 0007 00 through 0031 00 |
| Maintenance, Direct Support | 0032 00 through 0040 00 |
| Marine Corps Forms | 0041 00-3 |
| Marking and Restencilling (DS) | 0034 00-1 |
| Marking and Restencilling (Unit) | 0014 00-1 |
| Marking Parachutes | 0003 00-2 |
| Marking Risers | 0003 00-2 |
| Mending Cloth Patching Specifications, Table 3 | 0012 00-8 |
| Modification Work Order Compliance Record Page | 0003 00-6 |

N

| | |
|---|-----------|
| National Stock Number Index | 0053 00-1 |
| Nomenclature Cross-Reference List | 0001 00-3 |
| Note Page | 0003 00-8 |

O

| | |
|---------------------|-----------|
| Official Name | 0001 00-3 |
|---------------------|-----------|

Subject

WP Sequence No. – Page No.

O - Continued

Official Name0001 00-3
 Orientation0011 00-5
 Orifice Edge Reinforcement, Repair (Unit)0016 00-1

P

Pack Tray, Repair (Unit).....0031 00-1
 Pack Tray, Replace (Unit)0031 00-2
 Packing Procedures0011 00-1
 Pack-In-Process Inspection.....0009 00-1
 Parachute Log Record0003 00-3
 Parachute Repack Interval0005 00-1
 Part Number Index0055 00-1
 Patching (Unit).....0012 00-7
 Pocket Band, Repair (Unit).....0021 00-1
 Pocket Band, Replace (Unit)0021 00-1
 Position Control Lines0003 00-2
 Preparation for Shipment 0001 00-3/0037 00-1
 Preparation for Storage 0001 00-3/0039 00-1
 Preparing Parachute for Proper Layout0011 00-7
 Preventive Maintenance Checks And Services (PMCS)0006 00-1
 Preventive Maintenance Checks And Services (PMCS), Introduction.....0005 00-1
 Publication Indexes0041 00-1
 Purpose of Equipment.....0001 00-1

R

Radial Seam, Repair (Unit)0019 00-1
 Radial Tape, Replace (DS)0037 00-1
 Receipt of Used Parachute0003 00-9
 References0041 00-1
 References, Air Force Technical Order Forms0041 00-2
 References, Air Force Technical Orders0041 00-2
 References, Army Regulations.....0041 00-2
 References, DA PAM0041 00-1
 References, Field Manuals.....0041 00-2
 References, Forms0041 00-2
 References, Marine Corps Forms0041 00-3
 References, Publication Indexes.....0041 00-1
 References, Technical Bulletins0041 00-2
 References, Technical Manuals0041 00-1
 Remarking and Restencilling (DS)0031 00-2
 Remarking and Restencilling (Unit).....0014 00-2
 Removing Inversion.....0011 00-7
 Removing Tangles/Twists From Apex Lines0011 00-7
 Removing Turns/Tangles/Twists From Suspension Lines0011 00-10
 Repair Parts and Special Tools List (RPSTL)0044 00 to 0051 00

Subject

WP Sequence No. – Page No.

R - Continued

Repair Parts and Special Tools List (RPSTL), Introduction0043 00-1
 Replacing a Filled Out or Unserviceable Log Record0003 00-8
 Replacing a Lost Log Record0003 00-9
 Reporting Equipment Improvement Recommendations (EIRs)0001 00-2
 Reporting Errors and Recommending Improvementsi
 Restenciling (DS).....0034 00-1
 Restenciling (Unit)0014 00-1
 Restitching (DS)0032 00-2
 Restitching (Unit)0012 00-2
 Rigger Rolling0040 00-4
 Rigger's Orientation0011 00-6
 Rinsing Parachute Assembly Immersed in Fresh-Water 0008 00-3/0010 00-2
 Rinsing Parachute Assembly Immersed in Salt-Water 0008 00-2/0010 00-1
 Risers, Repair (Unit)0028 00-1
 Risers, Replace (Unit)0028 00-3
 Routine Inspection0009 00-1

S

Safety, Care and Handling0001 00-5
 Salt-Water Contamination Test0010 00-1
 Scope on Manual.....0001 00-1
 Searing and Waxing (DS).....0033 00-1
 Searing and Waxing (Unit)0013 00-1
 Service Upon Receipt.....0003 00-1
 Sewing Machine Code Symbols, Table 1 (DS)0032 00-2
 Sewing Machine Code Symbols, Table 1 (Unit).....0012 00-2
 Sewing Procedures (DS)0032 00-1
 Sewing Procedures (Unit)0012 00-1
 Shakeout and Airing (Unit)0007 00-1
 Shipment0040 00-1
 Shipment, Preparation for0040 00-1
 Special Tools List0052 00-1
 Special Tools, TMDE and Support Equipment.....0001 00-5
 Standard Static Line Extension0011 00-53
 Static Line Assembly, Repair (Unit).....0029 00-8
 Static Line Assembly, Replace (Unit)0029 00-10
 Static Line Extension, Repair (Unit)0029 00-12
 Static Line Extension, Replace (Unit).....0029 00-13
 Stitching (DS)0032 00-2
 Stitching (Unit)0012 00-2
 Stitching and Restitching Specifications, Table 2 (DS)0032 00-2
 Stitching and Restitching Specifications, Table 2 (Unit).....0012 00-3
 Storage Criteria0039 00-1
 Storage Requirements, General.....0039 00-1
 Storage Specifics for Parachutes0039 00-1
 Storage, Preparation for0039 00-1
 Stowing the Canopy0011 00-31
 Stowing the Static Lines0011 00-48

Subject

WP Sequence No. – Page No.

S - Continued

| | |
|--|------------|
| Stowing the Suspension Lines | 0011 00-34 |
| Supporting Information | 0041 00-1 |
| Suspension Line Stow Loop, Restitching | 0029 00-2 |
| Suspension Line, Repair (Unit) | 0024 00-1 |
| Suspension Line, Replace (DS) | 0038 00-1 |

T

| | |
|--|------------|
| Table of Contents | ii |
| Technical Bulletins | 0041 00-2 |
| Technical Manuals | 0041 00-1 |
| Technical/Rigger-Type Inspection | 0009 00-2 |
| Temporary Tacking (DS) | 0032 00-1 |
| Temporary Tacking (Unit) | 0012 00-2 |
| Tools and Test Equipment Requirements, Table 2 | 0042 00-6 |
| Tying Connector Links | 0011 00-40 |
| Tying Static Line to Bridle Loop of Canopy | 0011 00-29 |
| Tying Suspension Line Protective Cover | 0011 00-40 |

U

| | |
|--|-------------------------|
| Unit and Direct Support Repair and Inspection Data | 0003 00-7 |
| Unit Maintenance Procedures | 0007 00 through 0031 00 |
| Universal Static Line | 0029 00-13 |
| Upper Lateral Band, Repair (Unit) | 0017 00-1 |
| Usable On Code | 0046 00-6 |

V

| | |
|--------------------------------|-----------|
| Vent Lines, Repair (DS) | 0035 00-1 |
| Vent Lines, Replace (DS) | 0035 00-1 |
| V-Tabs, Repair (Unit) | 0022 00-1 |
| V-Tabs, Replace (Unit) | 0022 00-1 |

W

| | |
|----------------------------|-----------|
| Warning Summary | a |
| Warranty Information | 0001 00-3 |
| Waxing (DS) | 0033 00-1 |
| Waxing (Unit) | 0013 00-1 |

Z

| | |
|-----------------------------|-----------|
| Zig-Zag Sewing (DS) | 0032 00-3 |
| Zig-Zag Sewing (Unit) | 0012 00-6 |

By Order of the Secretaries of the Army, Air Force, and Navy (Including the Marine Corps):

Official:



JOEL B. HUDSON
*Administrative Assistant to the
Secretary of the Army*

0200204

ERIC K. SHINSEKI
*General, United States Army
Chief of Staff*

MICHAEL E. RYAN
*GENERAL, USAF
Chief of Staff*

Official:

GEORGE T. BABBETT

*General, USAF
Commander, Air Force Materiel Command*

D.G. MORRAL
*Rear Admiral, USN
Program Executive Officer
For Expeditionary Warfare
Naval Sea Systems Command*

R.P. SHOCKEY

*Director, Program Support
Marine Corps Systems Command*

DISTRIBUTION:

To be distributed in accordance with Initial Distribution Number (IDN 253647), requirements for TM 10-1670-292-23&P.

THIS PAGE INTENTIONALLY LEFT BLANK

These are the instructions for sending an electronic 2028

The following format must be used if submitting an electronic 2028. The subject line must be exactly the same and all fields must be included; however only the following fields are mandatory: 1, 3, 4, 5, 6, 7, 8, 9, 10, 13, 15, 16, 17, and 27.

From: "Whomever" <whomever@avma27.army.mil>

To: amssbriml@natick.army.mil

Subject: DA Form 2028

1. **From:** Joe Smith
2. **Unit:** home
3. **Address:** 4300 Park
4. **City:** Hometown
5. **St:** MO
6. **Zip:** 77777
7. **Date Sent:** 19-OCT-93
8. **Pub no:** 55-2840-229-23
9. **Pub Title:** TM
10. **Publication Date:** 04-JUL-85
11. **Change Number:** 7
12. **Submitter Rank:** MSG
13. **Submitter FName:** Joe
14. **Submitter MName:** T
15. **Submitter LName:** Smith
16. **Submitter Phone:** 123-123-1234
17. **Problem:** 1
18. **Page:** 2
19. **Paragraph:** 3
20. **Line:** 4
21. **NSN:** 5
22. **Reference:** 6
23. **Figure:** 7
24. **Table:** 8
25. **Item:** 9
26. **Total:** 123
27. **Text:**

This is the text for the problem below line 27.

THIS PAGE INTENTIONALLY LEFT BLANK

| | | | | | | | |
|--|-----------------|-------------------|-------------------|---|---|---|--------------------------------|
| RECOMMENDED CHANGES TO PUBLICATIONS AND BLANK FORMS For use of this form, see AR 25-30; the proponent agency is ODISC4. | | | | | | Use Part II (reverse) for Repair Parts and Special Tool Lists (RPSTL) and Supply Catalogs/Supply Manuals (SC/SM). | DATE 21 October 2003 |
| TO: (Forward to proponent of publication or form) (Include ZIP Code) COMMANDER U.S. ARMY SOLDIER AND BIOLOGICAL CHEMICAL COMMAND ATTN: AMSSB-RIM-L KANSAS STREET NATICK, MA 01760-5052 | | | | | | FROM: (Activity and location) (Include ZIP Code) <i>PFC Jane Doe</i> <i>CO A 3rd Engineer BR</i> <i>Ft. Leonardwood, MO 63108</i> | |
| PART I – ALL PUBLICATIONS (EXCEPT RPSTL AND SC/SM) AND BLANK FORMS | | | | | | | |
| PUBLICATION/FORM NUMBER TM 10-1670-296-23&P | | | | DATE 30 October 2002 | TITLE Unit Manual for Ancillary Equipment for Low Velocity Air Drop Systems | | |
| ITEM NO. | PAGE NO. | PARA-GRAPH | LINE NO. * | FIGURE NO. | TABLE NO. | RECOMMENDED CHANGES AND REASON <i>(Provide exact wording of recommended changes, if possible).</i> | |
| | 0036 00-2 | | | | 1 | <i>In table 1, Sewing Machine Code Symbols, the second sewing machine code symbol should be MD ZZ not MD 22.</i> <i>Change the manual to show Sewing Machine, Industrial: Zig-Zag; 308 stitch; medium-duty; NSN 3530-01-181-1421 as a MD ZZ code symbol.</i> | |
| <small>*Reference to line numbers within the paragraph or subparagraph.</small> | | | | | | | |
| TYPED NAME, GRADE OR TITLE Jane Doe, PFC | | | | TELEPHONE EXCHANGE/AUTOVON, PLUS EXTENSION 508-233-4141 | | SIGNATURE Jane Doe <i>Jane Doe</i> | |

| | | |
|--|---|--------------------------------|
| TO: <i>(Forward direct to addressee listed in publication)</i> COMMANDER U.S. ARMY SOLDIER AND BIOLOGICAL CHEMICAL COMMAND ATTN: AMSSB-RIM-L KANSAS STREET NATICK, MA 01760-5052 | FROM: <i>(Activity and location) (Include ZIP Code)</i> <i>PFC Jane Doe</i> <i>CO A 3rd Engineer BR</i> <i>Ft. Leonardwood, MO 63108</i> | DATE 21 October 2003 |
|--|---|--------------------------------|

PART II – REPAIR PARTS AND SPECIAL TOOL LISTS AND SUPPLY CATALOGS/SUPPLY MANUALS

| | | |
|--|--------------------------------|---|
| PUBLICATION NUMBER TM 10-1670-296-23&P | DATE 30 October 2002 | TITLE Unit Manual for Ancillary Equipment for Low Velocity Air Drop Systems |
|--|--------------------------------|---|

| PAGE NO. | COLM NO. | LINE NO. | NATIONAL STOCK NUMBER | REFERENCE NO. | FIGURE NO. | ITEM NO. | TOTAL NO. OF MAJOR ITEMS SUPPORTED | RECOMMENDED ACTION |
|-----------|----------|----------|-----------------------|---------------|------------|----------|------------------------------------|--|
| 0066 00-1 | | | | | 4 | | | <i>Callout 16 in figure 4 is pointed to a <u>D-Ring</u>. In the Repair Parts List key for figure 4, item 16 is called a <u>Snap Hook</u>. Please correct one or the other.</i> |

SAMPLE

PART III – REMARKS *(Any general remarks or recommendations, or suggestions for improvement of publications and blank forms. Additional blank sheets may be used if more space is needed.)*

| | | |
|----------------------------|--|-----------|
| TYPED NAME, GRADE OR TITLE | TELEPHONE EXCHANGE/AUTOVON, PLUS EXTENSION | SIGNATURE |
|----------------------------|--|-----------|

| | | | | | | | |
|--|----------|------------|------------|--|--|--|------|
| <p align="center">RECOMMENDED CHANGES TO PUBLICATIONS AND BLANK FORMS</p> <p>For use of this form, see AR 25-30; the proponent agency is ODISC4.</p> | | | | | | Use Part II (<i>reverse</i>) for Repair Parts and Special Tool Lists (RPSTL) and Supply Catalogs/Supply Manuals (SC/SM). | DATE |
| TO: (<i>Forward to proponent of publication or form</i>) (<i>Include ZIP Code</i>) Commander, US Army Soldier and Biological Chemical Command ATTN: AMSSB-RIM-L(N) (Woodrow Boucher) Kansas Street, Natick, MA 01760-5052 | | | | | | FROM: (<i>Activity and location</i>) (<i>Include ZIP Code</i>) | |
| PART I – ALL PUBLICATIONS (EXCEPT RPSTL AND SC/SM) AND BLANK FORMS | | | | | | | |
| PUBLICATION/FORM NUMBER TM 10-1670-292-23&P | | | | DATE 1 February 2002 | TITLE Unit and Direct Support Maintenance Manual (including RPSTL for Parachutes, Personnel Type, NSNs 1670-01-262-2359 and 1670-01-487-0777 | | |
| ITEM NO. | PAGE NO. | PARA-GRAPH | LINE NO. * | FIGURE NO. | TABLE NO. | RECOMMENDED CHANGES AND REASON <i>(Provide exact wording of recommended changes, if possible).</i> | |
| | | | | | | | |
| <i>*Reference to line numbers within the paragraph or subparagraph.</i> | | | | | | | |
| TYPED NAME, GRADE OR TITLE | | | | TELEPHONE EXCHANGE/AUTOVON, PLUS EXTENSION | | SIGNATURE | |

| | | |
|---|--|-------------|
| TO: <i>(Forward direct to addressee listed in publication)</i> Commander, US Army Soldier and Biological Chemical Command ATTN: AMSSB-RIM-L(N) (Woodrow Boucher) Kansas Street, Natick, MA 01760-5052 | FROM: <i>(Activity and location) (Include ZIP Code)</i> | DATE |
|---|--|-------------|

PART II – REPAIR PARTS AND SPECIAL TOOL LISTS AND SUPPLY CATALOGS/SUPPLY MANUALS

| PUBLICATION NUMBER | | | | DATE | | | TITLE | |
|--------------------|----------|----------|-----------------------|---------------|------------|----------|------------------------------------|--------------------|
| PAGE NO. | COLM NO. | LINE NO. | NATIONAL STOCK NUMBER | REFERENCE NO. | FIGURE NO. | ITEM NO. | TOTAL NO. OF MAJOR ITEMS SUPPORTED | RECOMMENDED ACTION |
| | | | | | | | | |

PART III – REMARKS *(Any general remarks or recommendations, or suggestions for improvement of publications and blank forms. Additional blank sheets may be used if more space is needed.)*

| |
|------------------------------|
| Large empty area for remarks |
|------------------------------|

| | | |
|----------------------------|--|-----------|
| TYPED NAME, GRADE OR TITLE | TELEPHONE EXCHANGE/AUTOVON, PLUS EXTENSION | SIGNATURE |
|----------------------------|--|-----------|

| | | | | | | | |
|--|----------|------------|------------|--|--|--|------|
| <p align="center">RECOMMENDED CHANGES TO PUBLICATIONS AND BLANK FORMS</p> <p>For use of this form, see AR 25-30; the proponent agency is ODISC4.</p> | | | | | | Use Part II (<i>reverse</i>) for Repair Parts and Special Tool Lists (RPSTL) and Supply Catalogs/Supply Manuals (SC/SM). | DATE |
| TO: (<i>Forward to proponent of publication or form</i>) (<i>Include ZIP Code</i>) Commander, US Army Soldier and Biological Chemical Command ATTN: AMSSB-RIM-L(N) (Woodrow Boucher) Kansas Street, Natick, MA 01760-5052 | | | | | | FROM: (<i>Activity and location</i>) (<i>Include ZIP Code</i>) | |
| PART I – ALL PUBLICATIONS (EXCEPT RPSTL AND SC/SM) AND BLANK FORMS | | | | | | | |
| PUBLICATION/FORM NUMBER TM 10-1670-292-23&P | | | | DATE 1 February 2002 | TITLE Unit and Direct Support Maintenance Manual (including RPSTL for Parachutes, Personnel Type, NSNs 1670-01-262-2359 and 1670-01-487-0777 | | |
| ITEM NO. | PAGE NO. | PARA-GRAPH | LINE NO. * | FIGURE NO. | TABLE NO. | RECOMMENDED CHANGES AND REASON <i>(Provide exact wording of recommended changes, if possible).</i> | |
| | | | | | | | |
| <i>*Reference to line numbers within the paragraph or subparagraph.</i> | | | | | | | |
| TYPED NAME, GRADE OR TITLE | | | | TELEPHONE EXCHANGE/AUTOVON, PLUS EXTENSION | | SIGNATURE | |

| | | |
|---|--|-------------|
| TO: <i>(Forward direct to addressee listed in publication)</i> Commander, US Army Soldier and Biological Chemical Command ATTN: AMSSB-RIM-L(N) (Woodrow Boucher) Kansas Street, Natick, MA 01760-5052 | FROM: <i>(Activity and location) (Include ZIP Code)</i> | DATE |
|---|--|-------------|

PART II – REPAIR PARTS AND SPECIAL TOOL LISTS AND SUPPLY CATALOGS/SUPPLY MANUALS

| PUBLICATION NUMBER | | | | DATE | | | TITLE | |
|--------------------|----------|----------|-----------------------|---------------|------------|----------|------------------------------------|--------------------|
| PAGE NO. | COLM NO. | LINE NO. | NATIONAL STOCK NUMBER | REFERENCE NO. | FIGURE NO. | ITEM NO. | TOTAL NO. OF MAJOR ITEMS SUPPORTED | RECOMMENDED ACTION |
| | | | | | | | | |

PART III – REMARKS *(Any general remarks or recommendations, or suggestions for improvement of publications and blank forms. Additional blank sheets may be used if more space is needed.)*

| | | |
|----------------------------|--|-----------|
| TYPED NAME, GRADE OR TITLE | TELEPHONE EXCHANGE/AUTOVON, PLUS EXTENSION | SIGNATURE |
|----------------------------|--|-----------|

The Metric System and Equivalents

Linear Measure

1 centimeter = 10 millimeters = .39 inch
 1 decimeter = 10 centimeters = 3.94 inches
 1 meter = 10 decimeters = 39.37 inches
 1 dekameter = 10 meters = 32.8 feet
 1 hectometer = 10 dekameters = 328.08 feet
 1 kilometer = 10 hectometers = 3,280.8 feet

Weights

1 centigram = 10 milligrams = .15 grain
 1 decigram = 10 centigrams = 1.54 grains
 1 gram = 10 decigrams = .035 ounce
 1 dekagram = 10 grams = .35 ounce
 1 hectogram = 10 dekagrams = 3.52 ounces
 1 kilogram = 10 hectograms = 2.2 pounds
 1 quintal = 100 kilograms = 220.46 pounds
 1 metric ton = 10 quintals = 1.1 short tons

Liquid Measure

1 centiliter = 10 milliliters = .34 fl. ounce
 1 deciliter = 10 centiliters = 3.38 fl. ounces
 1 liter = 10 deciliters = 33.81 fl. ounces
 1 dekaliter = 10 liters = 2.64 gallons
 1 hectoliter = 10 dekaliters = 26.42 gallons
 1 kiloliter = 10 hectoliters = 264.18 gallons

Square Measure

1 sq. centimeter = 100 sq. millimeters = .155 sq. inch
 1 sq. decimeter = 100 sq. centimeters = 15.5 sq. inches
 1 sq. meter (centare) = 100 sq. decimeters = 10.76 sq. feet
 1 sq. dekameter (are) = 100 sq. meters = 1,076.4 sq. feet
 1 sq. hectometer (hectare) = 100 sq. dekameters = 2.47 acres
 1 sq. kilometer = 100 sq. hectometers = .386 sq. mile

Cubic Measure

1 cu. centimeter = 1000 cu. millimeters = .06 cu. inch
 1 cu. decimeter = 1000 cu. centimeters = 61.02 cu. inches
 1 cu. meter = 1000 cu. decimeters = 35.31 feet

Approximate Conversion Factors

| <i>To change</i> | <i>To</i> | <i>Multiply by</i> | <i>To change</i> | <i>To</i> | <i>Multiply by</i> |
|------------------|--------------------|--------------------|--------------------|---------------|--------------------|
| inches | centimeters | 2.540 | ounce-inches | newton-meters | .007062 |
| feet | meters | .305 | centimeters | inches | .394 |
| yards | meters | .914 | meters | feet | 3.280 |
| miles | kilometers | 1.609 | meters | yards | 1.094 |
| square inches | square centimeters | 6.451 | kilometers | miles | .621 |
| square feet | square meters | .093 | square centimeters | square inches | .155 |
| square yards | square meters | .836 | square meters | square feet | 10.764 |
| square miles | square kilometers | 2.590 | square meters | square yards | 1.196 |
| acres | square hectometers | .405 | square kilometers | square miles | .386 |
| cubic feet | cubic meters | .028 | square hectometers | acres | 2.471 |
| cubic yards | cubic meters | .765 | cubic meters | cubic feet | 35.315 |
| fluid ounces | milliliters | 29.573 | cubic meters | cubic yards | 1.308 |
| pints | liters | .473 | milliliters | fluid ounces | .034 |
| quarts | liters | .946 | liters | pints | 2.113 |
| gallons | liters | 3.785 | liters | quarts | 1.057 |
| ounces | grams | 28.349 | liters | gallons | .264 |
| pounds | kilograms | .454 | grams | ounces | .035 |
| short tons | metric tons | .907 | kilograms | pounds | 2.205 |
| pound-feet | newton-meters | 1.356 | metric tons | short tons | 1.102 |
| pound-inches | newton-meters | .11296 | | | |

Temperature (Exact)

| | | | | |
|----|---------------------------|-------------------------------|------------------------|----|
| _F | Fahrenheit temperature | 5/9 (after subtracting 32) | Celsius temperature | _C |
|----|---------------------------|-------------------------------|------------------------|----|

PIN: 065605-000